



**DPO70000SX Series
Oscilloscopes
User**





**DPO70000SX Series
Oscilloscopes
User**

Warning

The servicing instructions are for use by qualified personnel only. To avoid personal injury, do not perform any servicing unless you are qualified to do so. Refer to all safety summaries prior to performing service.

Supports DPO70000SX Series Product Firmware V10.0 and above

Copyright © Tektronix. All rights reserved. Licensed software products are owned by Tektronix or its subsidiaries or suppliers, and are protected by national copyright laws and international treaty provisions. Tektronix products are covered by U.S. and foreign patents, issued and pending. Information in this publication supersedes that in all previously published material. Specifications and price change privileges reserved.

TEKTRONIX and TEK are registered trademarks of Tektronix, Inc.

TekScope, TekConnect, and FastAcq are registered trademarks of Tektronix, Inc.

FastFrame, OpenChoice, MyScope, MultiView Zoom, SignalVu, TekExpress, TriMode, TekSecure, TekProbe, TekVPI, TekVISA, UltraSync, and PinPoint are trademarks of Tektronix.

Contacting Tektronix

Tektronix, Inc.
14150 SW Karl Braun Drive
P.O. Box 500
Beaverton, OR 97077
USA

For product information, sales, service, and technical support:

- In North America, call 1-800-833-9200.
- Worldwide, visit www.tek.com to find contacts in your area.

Table of Contents

Important safety information	vii
General safety summary	vii
Service safety summary	ix
Terms in the manual	ix
Terms on the product	ix
Symbols on the product	ix
Compliance Information	xi
EMC compliance	xi
Safety compliance	xii
Environmental compliance	xiii
Preface	xv

Install your instrument

Standard accessories	1
Operating requirements	2
Power supply requirements	3
Preventing instrument damage	3
Preventing ESD	3
Observe maximum input voltage	5
Selecting the proper attenuator	5
Connector cleaning	5
Proper connection technique	6
Power on the instrument	9
Power off the instrument	10
Multi-instrument configuration	10
Instrument stacking	10
Before startup	13
UltraSync™ bus cable	13
UltraSync™ bus cable connection order	13
Master and extension connection order	15
Multi-instrument power on	16
Switching between multi-instrument modes	20
ATI versus TekConnect channels	21
Multi-instrument status displays	22
Available features	22
DPO7AFP Auxiliary Front Panel (optional)	24

Inspect the instrument	24
Verify internal diagnostics pass	24
Windows interface guidelines	25
Signal path compensation	26
Connecting to a network	29
Adding a second monitor	30
Restoring instrument operating system and product software	30
Operating system restore	31
Internal recovery utility	31
Product software installation	31

Getting acquainted with your instrument

Front-panel connectors	33
Rear-panel connectors	35
Interface and display	36
Control panel	38
Accessing online help	39
Accessing menus and control windows	40

Inspect your instrument

Verify internal diagnostics pass	41
--	----

Acquisition

Signal path compensation	43
Setting up analog signal input	46
Using default setup	48
Using autoselect	49
Probe compensation and deskew	50
Acquisition concepts	50
Acquisition hardware	50
Sampling process	50
Real-Time sampling	50
Interpolated Real-Time sampling	50
Equivalent-Time sampling	51
Waveform record	51
Interpolation	51
How the acquisition modes work	52
Enable enhanced effective number of bits	52

Changing the acquisition mode	53
Starting and stopping an acquisition	54
Selecting the horizontal mode	55
Using FastAcq	57
Using DSP enhanced bandwidth	58
Setting the termination voltage	60
Using roll mode	61
Setting up a bus	62
Set up a serial bus	64
Set up a parallel bus	65
Set up bus display	67
Using FastFrame mode	68
Using FastFrame frame finder	70

Pinpoint triggers

Triggering concepts	73
Trigger event	73
Trigger modes	73
Trigger holdoff	73
Trigger coupling	74
Horizontal position	74
Slope and level	74
Delayed trigger system	74
Choosing a trigger type	75
Trigger selections	77
Checking trigger status	78
Using A (Main) and B (Delayed) triggers	79
Trigger on B event	80
B trigger after delay time	80
Triggering with reset	80
Correcting trigger position	81
Triggering with B-Event scan	82
Triggering on a parallel bus	85
Triggering on a serial bus	87
Triggering using visual triggers (Visual triggering)	89
Setting up action on event	91
Sending E-Mail on trigger	92
Setting up E-Mail on event	93
Using horizontal delay	95

Display a waveform

Setting the display style	97
Setting the display persistence	98
Setting the display format	99
Selecting the waveform interpolation	100
Adding screen text	101
Setting the graticule style	102
Setting the trigger level marker	103
Displaying the date and time	103
Using the color palettes	104
Setting reference waveform colors	105
Setting math waveform colors	106
Using MultiView zoom	107
Zooming in multiple areas	108
Lock and scroll zoomed waveforms	110
Hide waveforms in the zoomed window	111
Searching and marking waveforms	111
To manually set and clear (delete) marks:	112
To automatically set and clear (delete) search marks	114
Using a visual search	119

Analyzing waveforms

Taking automatic measurements	121
Automated measurement selections	122
Customizing an automatic measurement	125
Gating	126
Statistics	126
Snapshot	127
Annotate measurements	127
Reference levels	128
Taking cursor measurements	130
Setting up a histogram	132
Using math waveforms	134
Using spectral analysis	137
Using mask testing	140
Using limit testing	143

MyScope

Creating a new MyScope control window	145
Using MyScope control windows	149

Saving and recalling information

Saving screen captures	151
Saving waveforms	153
Recalling waveforms	155
Saving instrument setups	156
Recalling instrument setups	157
Saving measurements	158
Saving user masks	159
Saving histogram data	160
Saving timestamps	161
Copying your results to the clipboard	162
Printing a hard copy	164

Run application software

Application examples

Capturing intermittent anomalies	167
Using the extended desktop and OpenChoice architecture for efficient documentation	170
Triggering on buses	172

Appendix A, Maintenance

Maintenance	175
Cleaning	175
Exterior cleaning	175
Adjustment interval	176
Adjustment	176
Flat panel display cleaning	176
Returning the instrument for service	177
TekScope recovery report utility	177
Replaceable parts	179
Parts ordering information	180

Appendix B, Version releases

Obtaining the latest advanced analysis application and version releases 181

Important safety information

This manual contains information and warnings that must be followed by the user for safe operation and to keep the product in a safe condition.

To safely perform service on this product, see the *Service safety summary* that follows the *General safety summary*.

General safety summary

Use the product only as specified. Review the following safety precautions to avoid injury and prevent damage to this product or any products connected to it. Carefully read all instructions. Retain these instructions for future reference.

Comply with local and national safety codes.

For correct and safe operation of the product, it is essential that you follow generally accepted safety procedures in addition to the safety precautions specified in this manual.

The product is designed to be used by trained personnel only.

Only qualified personnel who are aware of the hazards involved should remove the cover for repair, maintenance, or adjustment.

Before use, always check the product with a known source to be sure it is operating correctly.

This product is not intended for detection of hazardous voltages.

Use personal protective equipment to prevent shock and arc blast injury where hazardous live conductors are exposed.

While using this product, you may need to access other parts of a larger system. Read the safety sections of the other component manuals for warnings and cautions related to operating the system.

When incorporating this equipment into a system, the safety of that system is the responsibility of the assembler of the system.

To avoid fire or personal injury

Use proper power cord. Use only the power cord specified for this product and certified for the country of use. Do not use the provided power cord for other products.

Ground the product. This product is grounded through the grounding conductor of the power cord. To avoid electric shock, the grounding conductor must be connected to earth ground. Before making connections to the input or output terminals of the product, ensure that the product is properly grounded. Do not disable the power cord grounding connection.

Power disconnect. The power cord disconnects the product from the power source. See instructions for the location. Do not position the equipment so that it is difficult to operate the power cord; it must remain accessible to the user at all times to allow for quick disconnection if needed.

Connect and disconnect properly. Do not connect or disconnect probes or test leads while they are connected to a voltage source. Use only insulated voltage probes, test leads, and adapters supplied with the product, or indicated by Tektronix to be suitable for the product.

Observe all terminal ratings. To avoid fire or shock hazard, observe all rating and markings on the product. Consult the product manual for further ratings information before making connections to the product.

Do not apply a potential to any terminal, including the common terminal, that exceeds the maximum rating of that terminal.

The measurement terminals on this product are not rated for connection to mains or Category II, III, or IV circuits.

Do not operate without covers. Do not operate this product with covers or panels removed, or with the case open. Hazardous voltage exposure is possible.

Avoid exposed circuitry. Do not touch exposed connections and components when power is present.

Do not operate with suspected failures. If you suspect that there is damage to this product, have it inspected by qualified service personnel.

Disable the product if it is damaged. Do not use the product if it is damaged or operates incorrectly. If in doubt about safety of the product, turn it off and disconnect the power cord. Clearly mark the product to prevent its further operation.

Before use, inspect voltage probes, test leads, and accessories for mechanical damage and replace when damaged. Do not use probes or test leads if they are damaged, if there is exposed metal, or if a wear indicator shows.

Examine the exterior of the product before you use it. Look for cracks or missing pieces.

Use only specified replacement parts.

Do not operate in wet/damp conditions. Be aware that condensation may occur if a unit is moved from a cold to a warm environment.

Do not operate in an explosive atmosphere.

Keep product surfaces clean and dry. Remove the input signals before you clean the product.

Provide proper ventilation. Refer to the manual's installation instructions for details on installing the product so it has proper ventilation.

Slots and openings are provided for ventilation and should never be covered or otherwise obstructed. Do not push objects into any of the openings.

Provide a safe working environment. Always place the product in a location convenient for viewing the display and indicators.

Avoid improper or prolonged use of keyboards, pointers, and button pads. Improper or prolonged keyboard or pointer use may result in serious injury.

Be sure your work area meets applicable ergonomic standards. Consult with an ergonomics professional to avoid stress injuries.

Use care when lifting and carrying the product. This product is provided with handles for lifting and carrying.



WARNING. *The product is heavy. To reduce the risk of personal injury or damage to the device get help when lifting or carrying the product.*

Use only the Tektronix rackmount hardware specified for this product.

Service safety summary

The *Service safety summary* section contains additional information required to safely perform service on the product. Only qualified personnel should perform service procedures. Read this *Service safety summary* and the *General safety summary* before performing any service procedures.

To avoid electric shock. Do not touch exposed connections.

Do not service alone. Do not perform internal service or adjustments of this product unless another person capable of rendering first aid and resuscitation is present.

Disconnect power. To avoid electric shock, switch off the product power and disconnect the power cord from the mains power before removing any covers or panels, or opening the case for servicing.

Use care when servicing with power on. Dangerous voltages or currents may exist in this product. Disconnect power, remove battery (if applicable), and disconnect test leads before removing protective panels, soldering, or replacing components.

Verify safety after repair. Always recheck ground continuity and mains dielectric strength after performing a repair.

Terms in the manual

These terms may appear in this manual:



WARNING. Warning statements identify conditions or practices that could result in injury or loss of life.



CAUTION. Caution statements identify conditions or practices that could result in damage to this product or other property.

Terms on the product

These terms may appear on the product:

- DANGER indicates an injury hazard immediately accessible as you read the marking.
- WARNING indicates an injury hazard not immediately accessible as you read the marking.
- CAUTION indicates a hazard to property including the product.

Symbols on the product



When this symbol is marked on the product, be sure to consult the manual to find out the nature of the potential hazards and any actions which have to be taken to avoid them. (This symbol may also be used to refer the user to ratings in the manual.)

The following symbols may appear on the product:



CAUTION
Refer to Manual

WARNING
High Voltage

Protective Ground
(Earth) Terminal

Earth Terminal

Chassis Ground

Standby

Compliance Information

This section lists the EMC (electromagnetic compliance), safety, and environmental standards with which the instrument complies.

EMC compliance

EC Declaration of Conformity – EMC

Meets intent of Directive 2004/108/EC for Electromagnetic Compatibility. Compliance was demonstrated to the following specifications as listed in the Official Journal of the European Communities:

EN 61326-1, EN 61326-2-1. EMC requirements for electrical equipment for measurement, control, and laboratory use. ^{1 2 3 4}

- CISPR 11. Radiated and conducted emissions, Group 1, Class A
- IEC 61000-4-2. Electrostatic discharge immunity
- IEC 61000-4-3. RF electromagnetic field immunity ⁵
- IEC 61000-4-4. Electrical fast transient / burst immunity
- IEC 61000-4-5. Power line surge immunity
- IEC 61000-4-6. Conducted RF immunity ⁵
- IEC 61000-4-11. Voltage dips and interruptions immunity

EN 61000-3-2. AC power line harmonic emissions

EN 61000-3-3. Voltage changes, fluctuations, and flicker

Mfr. Compliance Contact.

Tektronix, Inc. PO Box 500, MS 19-045
Beaverton, OR 97077, USA
www.tek.com

Australia / New Zealand Declaration of Conformity – EMC

Complies with the EMC provision of the Radiocommunications Act per the following standard, in accordance with ACMA:

- CISPR 11. Radiated and conducted emissions, Group 1, Class A, in accordance with EN 61326-1 and EN 61326-2-1.

¹ This product is intended for use in nonresidential areas only. Use in residential areas may cause electromagnetic interference.

² Emissions which exceed the levels required by this standard may occur when this equipment is connected to a test object.

³ If interconnect cables are used, they must be high quality, low-EMI shielded cables.

⁴ Equipment may not meet the immunity requirements of this standard when test leads and/or test probes are connected due to coupling of electromagnetic interference onto those leads/probes. To minimize the influence of electromagnetic interference, minimize the loop area between the unshielded portions of signal and associated return leads, and keep leads as far away as possible from electromagnetic disturbance sources. Twisting unshielded test leads together is an effective way to reduce loop area. For probes, keep the ground return lead as short as possible and close to the probe body. Some probes have accessory probe tip adapters to accomplish this most effectively. In all cases, observe all safety instructions for the probes or leads used.

⁵ The performance criterion for when the oscilloscope is subjected to the continuously present electromagnetic phenomenon: 10 mV/division to 1 V/division: ≤ 0.4 division waveform displacement or ≤ 0.8 division increase in peak-to-peak noise.

Safety compliance

This section lists the safety standards with which the product complies and other safety compliance information.

EU declaration of conformity – low voltage

Compliance was demonstrated to the following specification as listed in the Official Journal of the European Union:

Low Voltage Directive 2006/95/EC.

- EN 61010-1. Safety Requirements for Electrical Equipment for Measurement, Control, and Laboratory Use – Part 1: General Requirements.

U.S. nationally recognized testing laboratory listing

- UL 61010-1. Safety Requirements for Electrical Equipment for Measurement, Control, and Laboratory Use – Part 1: General Requirements.

Canadian certification

- CAN/CSA-C22.2 No. 61010-1. Safety Requirements for Electrical Equipment for Measurement, Control, and Laboratory Use – Part 1: General Requirements.

Additional compliances

- IEC 61010-1. Safety Requirements for Electrical Equipment for Measurement, Control, and Laboratory Use – Part 1: General Requirements.

Equipment type

Test and measuring equipment.

Safety class

Class 1 – grounded product.

Pollution degree description

A measure of the contaminants that could occur in the environment around and within a product. Typically the internal environment inside a product is considered to be the same as the external. Products should be used only in the environment for which they are rated.

- Pollution Degree 1. No pollution or only dry, nonconductive pollution occurs. Products in this category are generally encapsulated, hermetically sealed, or located in clean rooms.
- Pollution Degree 2. Normally only dry, nonconductive pollution occurs. Occasionally a temporary conductivity that is caused by condensation must be expected. This location is a typical office/home environment. Temporary condensation occurs only when the product is out of service.
- Pollution Degree 3. Conductive pollution, or dry, nonconductive pollution that becomes conductive due to condensation. These are sheltered locations where neither temperature nor humidity is controlled. The area is protected from direct sunshine, rain, or direct wind.
- Pollution Degree 4. Pollution that generates persistent conductivity through conductive dust, rain, or snow. Typical outdoor locations.

Pollution degree

Pollution Degree 2 (as defined in IEC 61010-1). Note: Rated for indoor, dry location use only.

IP rating

IP20 (as defined in IEC 60529).

Measurement and overvoltage category descriptions

Measurement terminals on this product may be rated for measuring mains voltages from one or more of the following categories (see specific ratings marked on the product and in the manual).

- Measurement Category II. For measurements performed on circuits directly connected to the low-voltage installation.
- Measurement Category III. For measurements performed in the building installation.
- Measurement Category IV. For measurements performed at the source of low-voltage installation.

NOTE. Only mains power supply circuits have an overvoltage category rating. Only measurement circuits have a measurement category rating. Other circuits within the product do not have either rating.

Mains overvoltage category rating

Overvoltage Category II (as defined in IEC 61010-1)

Environmental compliance

This section provides information about the environmental impact of the product.

Product end-of-life handling

Observe the following guidelines when recycling an instrument or component:

Equipment recycling. Production of this equipment required the extraction and use of natural resources. The equipment may contain substances that could be harmful to the environment or human health if improperly handled at the product's end of life. To avoid release of such substances into the environment and to reduce the use of natural resources, we encourage you to recycle this product in an appropriate system that will ensure that most of the materials are reused or recycled appropriately.



This symbol indicates that this product complies with the applicable European Union requirements according to Directives 2012/19/EU and 2006/66/EC on waste electrical and electronic equipment (WEEE) and batteries. For information about recycling options, check the Tektronix Web site (www.tek.com/productrecycling).

Perchlorate materials. This product contains one or more type CR lithium batteries. According to the state of California, CR lithium batteries are classified as perchlorate materials and require special handling. See www.dtsc.ca.gov/hazardouswaste/perchlorate for additional information.

Restriction of hazardous substances

This product is classified as an industrial monitoring and control instrument, and is not required to comply with the substance restrictions of the recast RoHS Directive 2011/65/EU until July 22, 2017.

Preface

This manual describes the installation and basic operation of DPO7000SX series instruments. For additional operating information, refer to the instrument help on your instrument. The following instruments are supported by this document:

- DPO77002SX
- DPO75902SX
- DPO75002SX
- DPO73304SX
- DPO72304SX

Key features

DPO7000SX Series instruments can help you verify, debug, and characterize electronic designs. Key features include:

- 70 GHz bandwidth and 200 GS/s on 1 analog channel and 33 GHz bandwidth and 100 GS/s on 2 analog channels, DPO77002SX
- 59 GHz bandwidth and 200 GS/s on 1 analog channel and 33 GHz bandwidth and 100 GS/s on 2 analog channels, DPO75902SX
- 50 GHz bandwidth and 200 GS/s on 1 analog channel and 33 GHz bandwidth and 100 GS/s on 2 analog channels, DPO75002SX
- 33 GHz bandwidth and 100 GS/s on 2 analog channels or 4 channels at 50 GS/s, DPO73304SX
- 23 GHz bandwidth and 100 GS/s on 2 analog channels or 4 channels at 50 GS/s, DPO72304SX
- Enhanced Bandwidth capability that, when enabled, applies Digital Signal Processing (DSP) filters that can extend the bandwidth and flatten the passband. Enhanced Bandwidth provides a matched response across enabled channels when they are at maximum sample rate. You can limit the bandwidth down to 500 MHz to optimize the signal to noise ratio. Enhanced bandwidth is extended to the probe tip for some high performance probes and tips.
- Record lengths up to 1,000,000,000 samples, depending on model and option
- Up to 1.0% DC vertical gain accuracy, depending on model
- Combine up to 4 instruments using UltraSync™ interface for increased channel count.
- Display user interface on an optional external monitor
- Up to 4 analog input channels, depending on model (each with 8-bit resolution when not in Hi-Res mode), auxiliary trigger input and output
- Full programmability, with an extensive command set and a message-based interface
- PinPoint triggering with flexible A and B trigger events
- Edge trigger >20 GHz, Aux trigger > 10 GHz.
- Selectable trigger position correction to more accurately place the trigger and reduce jitter
- Powerful built-in measurement capability, including histograms, automatic measurements, eye pattern measurements and measurement statistics
- Mathematically combine waveforms to create waveforms that support your data-analysis task. Use arbitrary filters in math equations. Use spectral analysis to analyze waveforms in the frequency domain.
- Ability to control sample rate and record length separately from horizontal scale

- An intuitive, graphical user interface (UI), with online help that is built in and available on screen
- Internal, removable disk storage

Documentation

Review the following table to locate more information about this product.

To read about	Use these documents
Installation and operation (overviews)	User manual.
Operation and user interface	Instrument help from the Help menu.
Programmer commands	Programmer manual. This manual is available on the Tektronix Web site (www.tektronix.com/manuals).

Conventions used in this manual

The following icons are used throughout this manual.

Step	Front panel power	Connect power	Network	PS-2	SVGA	USB
1						

Install your instrument

Unpack the instrument and check that you received all items listed as Standard Accessories. Recommended accessories, probes, instrument options, and upgrades are listed in the online help. Check the Tektronix Web site (www.tektronix.com) for the most current information.

Standard accessories

Accessory	Tektronix part number
User manual -- depends on language option	071-3357-xx
Front protective cover , TekConnect instruments	200-5337-00
ATI instruments	200-5358-00
PCIe Host Port protective plug	200-5344-00
2nd ethernet port plug	200-5389-00
50 Ω term on Fast Edge (2X)	015-1022-01
TCA-292D (5X) (3X on ATI instruments)	090-0044-00
Windows compatible keyboard	119-7275-xx
Windows compatible mouse	119-7054-xx
Static protection wrist strap	006-3415-05
Deskew cable (M2.92 to M2.92)	174-6793-00
Deskew adapter (1.85F to 2.92F), ATI instruments only	103-0483-00
Attenuator 2.92 mm female to 2.92 mm male, 50 Ω , 10 DB	011-0221-00
ATI connector saver (1.85mm), ATI instruments only	103-0474-00
ATI protective cap, ATI instruments only	016-2101-00
Torque wrench, ATI instruments only	067-2787-00
Backing wrench, ATI instruments only	003-1942-00
Accessories pouch	016-2045-00
Best Practices manual	071-2989-04
ROHS info	071-2185-04
Calibration certification	001-1179-00
Cal cert envelope	006-8018-01
Power cord – one of the following:	

Accessory	Tektronix part number
North America (Option A0)	161-0213-00
Universal Euro (Option A1)	161-0209-00
United Kingdom (Option A2)	161-0210-00
Australia (Option A3)	161-0211-01
Switzerland (Option A5)	161-0212-01
Japan (Option A6)	161-0213-00
China (Option A10)	161-0320-00
India (Option A11)	161-0325-00
Brazil (Option A12)	161-0358-00
No power cord (Option A99)	

Operating requirements



WARNING.

To prevent injury and instrument damage, do not operate the instrument while the instrument is resting on its rear feet.

1. Place the instrument on a cart or bench. The instrument should rest on its bottom feet. An optional rack mounting kit is available. Observe the following clearance requirements and dimensions:
 - Top: 0 in (0 mm)
 - Left side: 3 in (76 mm)
 - Right side: 3 in (76 mm)
 - Rear: 3 in (76 cm) beyond the rear feet to protect any cables connected to the rear panel
 - Bottom: 0 in (0 mm) standing on feet, flip stands down



CAUTION. To ensure proper cooling, keep the bottom and sides of the instrument clear of obstructions.

To ensure proper cooling, if the instruments are stacked on top of each other, the bottom feet must remain on the instruments.

2. Width: 19.0 inches (483 mm)
3. Height: 6.0 inches (152 mm)
4. Before operating the instrument, verify the ambient temperature: 5 °C to +45 °C (+41 °F to +113 °F)
5. Verify the operating humidity: 8% to 80% relative humidity at up to +32 °C (+90 °F)
5% to 45% relative humidity above +32 °C (+90 °F) up to +45 °C (+113 °F), noncondensing, and is limited by a maximum wet-bulb temperature of +29.4 °C (+85 °F) (derate relative humidity to 32% at +45 °C (+113 °F))
6. Verify the operating altitude: 3,000 m (9,843 feet), derate maximum operating temperature by 1 °C per 300 meters (984.25 feet) above 1500 meters (4921.25 feet) altitude.
7. Maximum input voltage:

TekConnect channels: ≤1.2 V/FS settings:
±1.5 V relative to the termination bias (30 mA maximum).

± 5 V absolute maximum input.

>1.2 V/FS settings: ± 8.0 V. Limited by maximum V_{term} current and the attenuator power.

ATI Channel: $\pm 0.75 V_{pk}$

Aux channel: $\pm 5.0 V_{pk}$

Power supply requirements

The power supply requirements for your instrument are listed in the following table.

Source Voltage and Frequency	Power Consumption
100 VAC to 240 VAC, 50/60 Hz or 115 VRMS, 400 Hz.	980 W



WARNING.

To reduce the risk of fire and shock, ensure that the mains supply voltage fluctuations do not exceed 10% of the operating voltage range.

Preventing instrument damage

Preventing ESD



CAUTION. A direct electrostatic discharge can damage the instrument input. To learn how to avoid this damage, read the following information.

Electrostatic discharge (ESD) is a concern when handling any electronic equipment. The instrument is designed with robust ESD protection, however it is still possible that large discharges of static electricity directly into the signal input may damage the instrument. To avoid damage to the instrument, use the following techniques to prevent electrostatic discharge to the instrument.

1. Discharge the static voltage from your body by wearing a grounded antistatic wrist strap while connecting and disconnecting cables and TekConnect adapters. The instrument provides a front panel connection for this purpose.

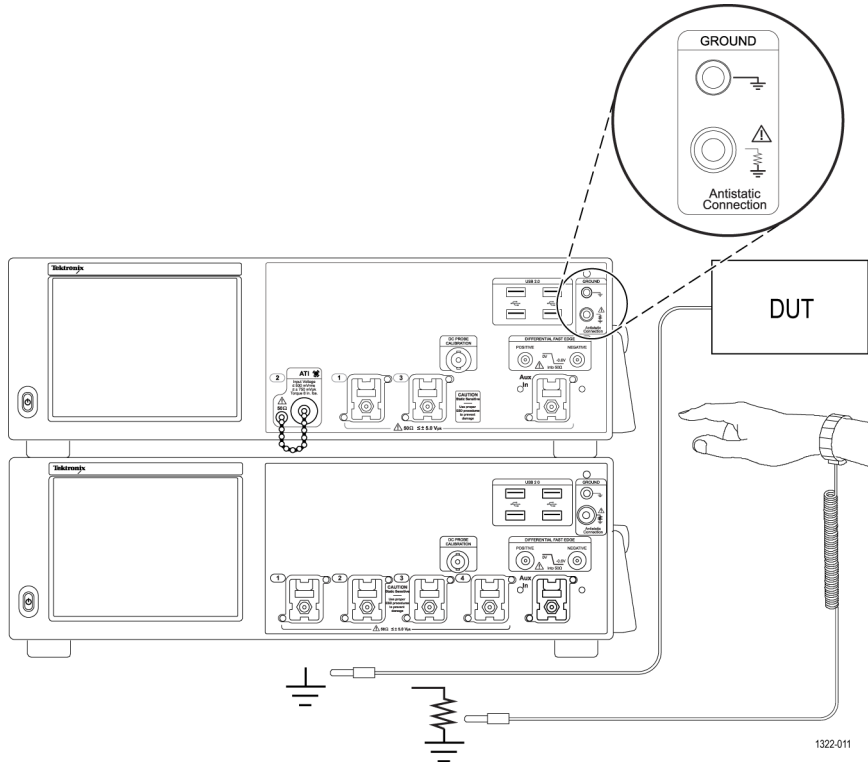

2. A cable that is left unconnected on a bench, or carried across a room, can develop a large static charge. Discharge the static voltage from all cables before connecting them to the instrument or device under test by momentarily grounding the center conductor of the cable, or by connecting a 50 Ω termination to one end, before attaching the cable to the instrument.

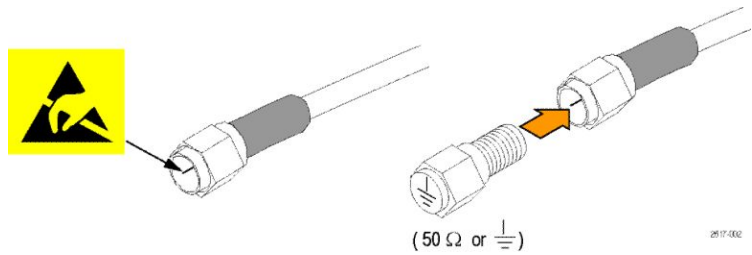

CAUTION. Do not use a tool (such as a screwdriver, wrench end, etc) to short the center conductor to the ground shell on the connector, as any sort of scratch or nick may damage the RF response of the cable.

Observe maximum input voltage



WARNING. Observe all terminal ratings. To avoid damaging the instrument, observe all rating and markings on the product. Consult the product manual for further ratings information before making connections to the product.

Do not apply a potential to any terminal, including the common terminal, that exceeds the maximum rating of that terminal.

The maximum input voltage for the ATI (Asynchronous Time-Interleaved) input is $\pm 0.75 V_{pk}$. This is the maximum voltage before damage occurs.

The maximum input voltage for the TekConnect inputs is $\pm 1.5 V$ relative to the termination bias (30 mA maximum) on $\leq 1.2 V$ full scale settings and 8 V on $>1.2 V$ full scale settings.

Selecting the proper attenuator

The ATI input has a maximum voltage range of $300 mV_{FS}$. Use of an attenuator can increase the maximum voltage range.

Table 4: Maximum ATI voltage range

Attenuator	Maximum ATI voltage range
None	$300 mV_{FS}$
3 dB	$420 mV_{FS}$
6 dB	$600 mV_{FS}$
10 dB	$950 mV_{FS}$
16 dB (6 dB + 10 dB attenuators)	$1.88 V_{FS}$
20 dB	$3 V_{FS}$

Connector cleaning

All connectors must be kept clean. Dirt in connectors can damage the connector and any connectors the dirty connector is used with. Dirt will also likely impair the RF performance. All cables, attenuators, and adapters should be stored with connector covers to keep dust out.

Before each use do the following:

1. Verify that the connectors are free of dirt, metal particles, scratches and deformations.
2. Verify the connectors are the correct size.



WARNING. To avoid eye damage, wear eye protection when using compressed air.

3. With the connector pointed down, use low pressure compressed air, at an angle to the connector, to clean the connectors.
4. If the connector still needs cleaning, use an appropriately sized swab moistened with isopropyl alcohol to clean the connector threads and mating surfaces. Do not snag the center conductor.



CAUTION. Never put pressure on the center pin of the connectors. Applying pressure to the center pin could damage the connector.

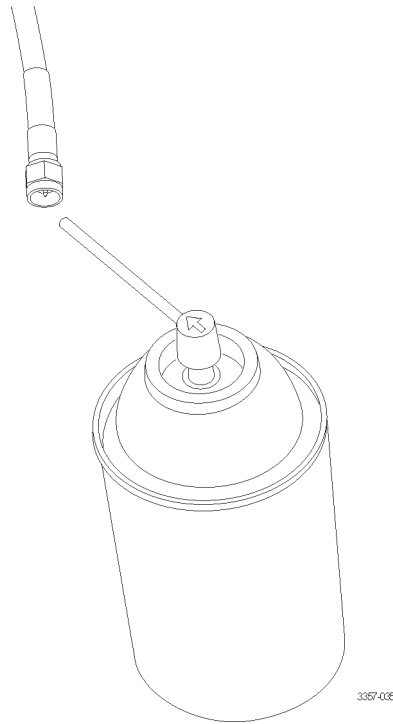

Proper connection technique

Use 8 inch-pounds of torque when making connections to the ATI 1.85 mm connector, SMA connectors, adapters, DC Blocks, or cables. Using the improper torque or connection technique may degrade your signals and damage the connectors.

Use the following procedure to make connections to the ATI input:



CAUTION. Failure to use the supplied backing wrench and torque wrench when making connections to the ATI input may damage your instrument.

1. Discharge the static voltage from your body by wearing a grounded antistatic wrist strap while connecting and disconnecting cables and adapters. The instrument provides a front panel connection for this purpose. Use the ground connection with the black plastic grommet, as this has a 1 M Ω series isolation resistance, so that there is no chance of shock, but the static voltage can be discharged.

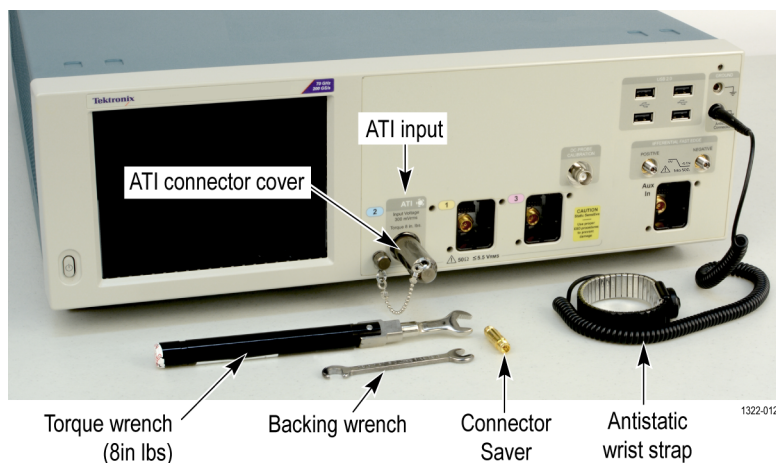

Figure 1: Wear an antistatic wrist strap

2. Use the supplied connector saver to protect the instrument connector. When not in use, protect against dirt and ESD damage by installing the end cap. Alternate locations to store the ATI protective cover include the upper right corner of the front panel and to the right of the audio connectors on the rear panel. When installing the connector saver tighten to 8 inch-pounds.



CAUTION. The connector saver can appear to tighten/loosen opposite to expectations because the oscilloscope ATI input connector is a male connector.

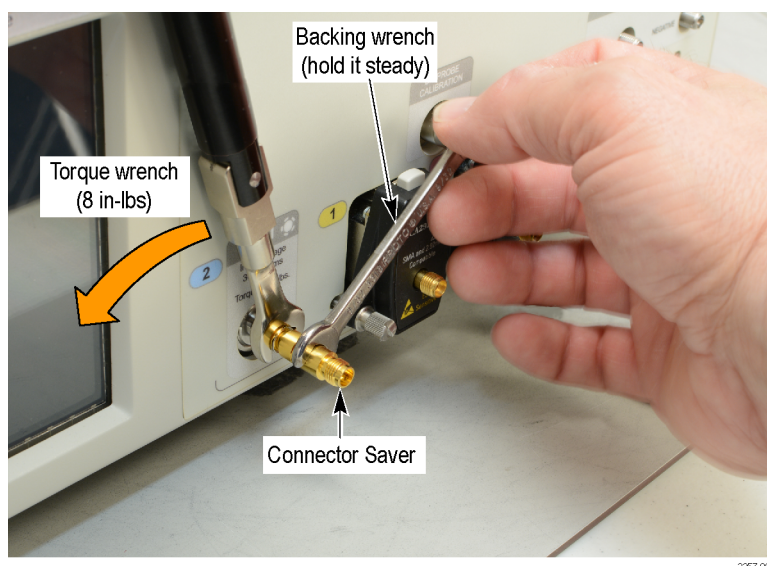

Figure 2: Installing a connector saver

3. Use the backing wrench on the connector saver to prevent damage caused by rotation of the connectors when installing a connector.

4. Use the supplied torque wrench to tighten (8 inch-pounds) your cable connector to the connector saver.

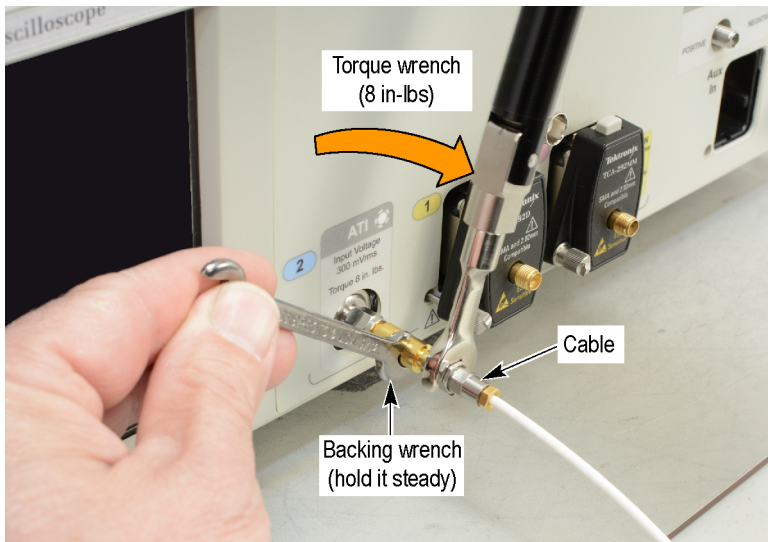

Figure 3: Installing a cable



CAUTION. Failure to prevent rotation of the center conductors when making connections to the ATI input will damage your instrument. If necessary use a second backing wrench on the cable, to prevent its rotation. Use the supplied torque wrench to tighten (8 inch-pounds) all connectors.

5. If necessary use a second backing wrench on the cable, to prevent its rotation.

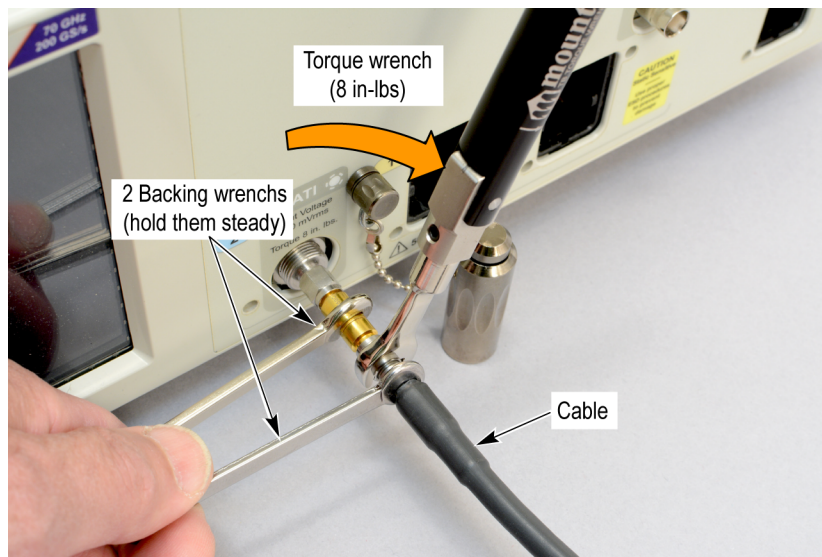
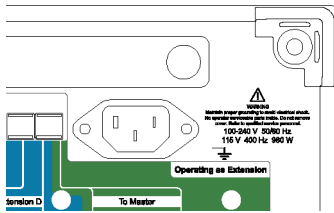

Figure 4: Use a second backing wrench

Power on the instrument

1. Connect the AC power cord to the rear of the instrument.



2. Use the front-panel power button to switch the instrument on.

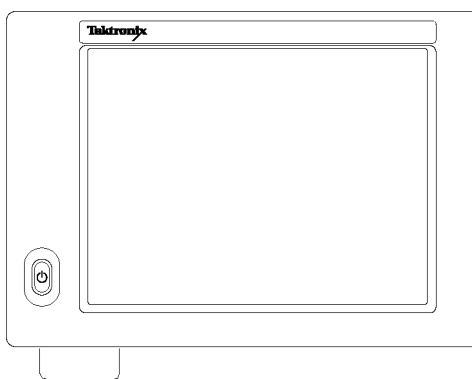

The power button indicates instrument power states:

- No light – no power applied
- Green – powered on

Power off the instrument

1. Press the front-panel power button to shut down the instrument.

NOTE. If powering off a multi-instrument configuration, power off the master first.

The shutdown process takes approximately 30 seconds to complete, placing the instrument in standby mode. Alternatively, use the Windows Shutdown menu.

NOTE. You can force an immediate shutdown by pressing and holding the power button for four seconds. Unsaved data is lost.

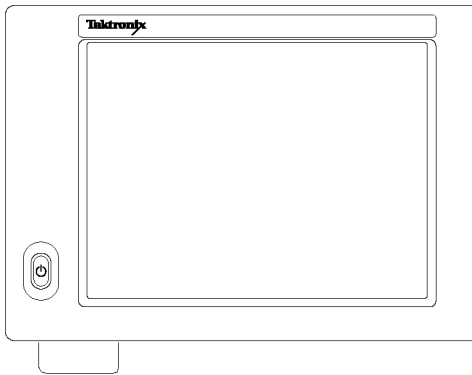

2. To completely remove power to the instrument, perform the shutdown just described, and then remove the power cord from the instrument.

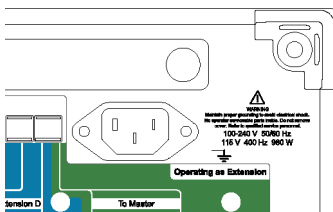

Multi-instrument configuration

Connect instruments in a multi-instrument configuration to create an up to 4 channel, highest bandwidth, and highest sample rate system with synchronized trigger and sample clock.

Instrument stacking

Multiple instruments may be stacked to save space and allow shorter cables and more convenient connections.



WARNING. When using an instrument upside down, be careful to avoid pinching your fingers.

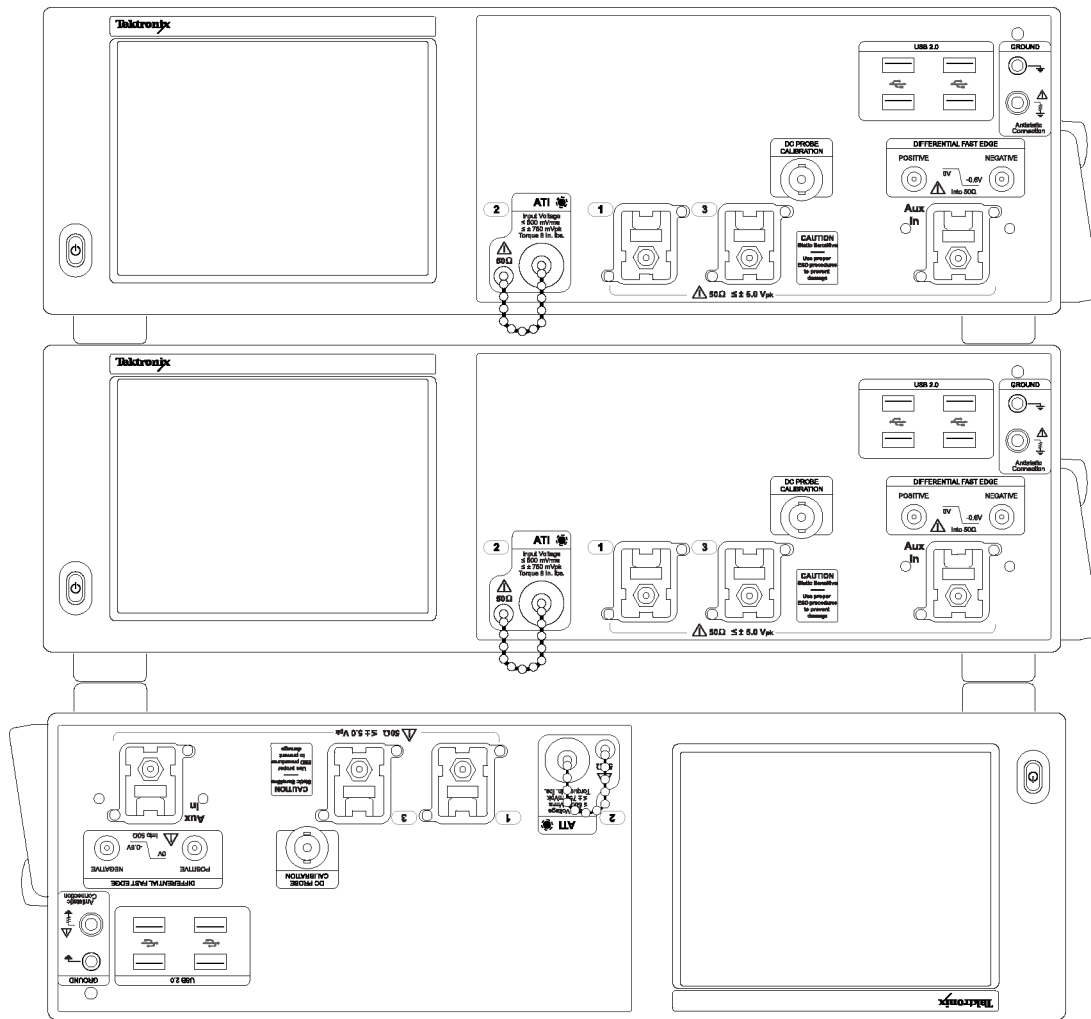

3367-034

Standard orientation of the top feet is useful when placing an instrument inverted on the work bench. Standard orientation of the top feet is also use when stacking an OM4000 on the instrument.



Use the rotated orientation of the top feet to stack two instruments on top of each other.

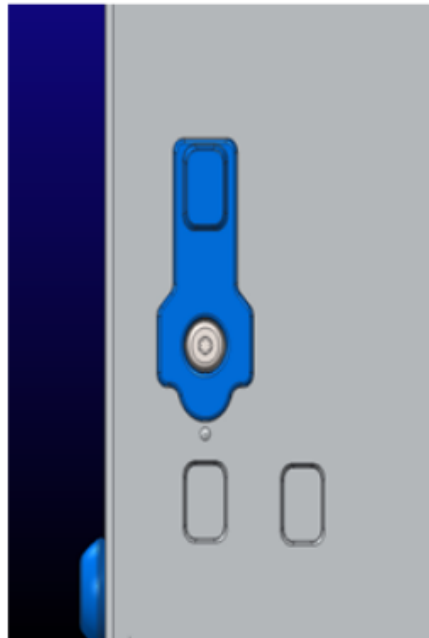

When stacking two instruments, the bottom feet sit in the holes exposed when the top feet are rotated.

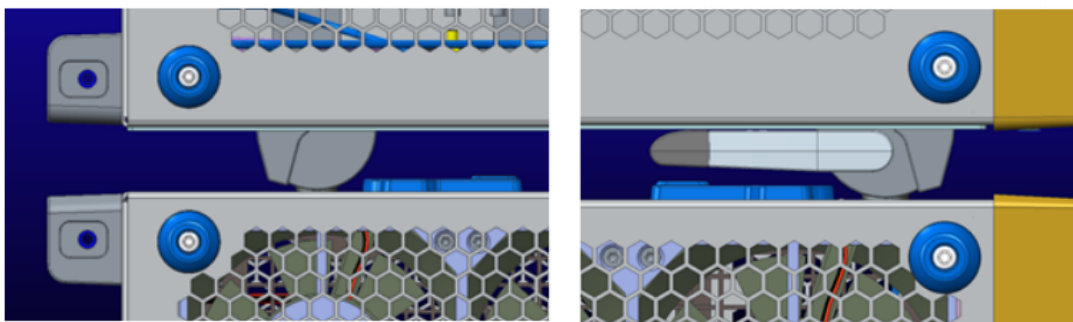

Before startup

All instruments in a multi-Instrument configuration must be connected properly before powering on the instruments. If the configuration is changed after the instruments are powered on, a system restart may be required.

If an instrument is not connected in a multi-instrument configuration, the instrument powers on in its stand alone mode, not multi-instrument mode.

UltraSync™ bus cable

An UltraSync bus cable will connect any multi-instrument configuration capable instrument.

All cables must be connected to the instruments prior to power up. A restart will be required if the instruments are turned on before the cables are connected.

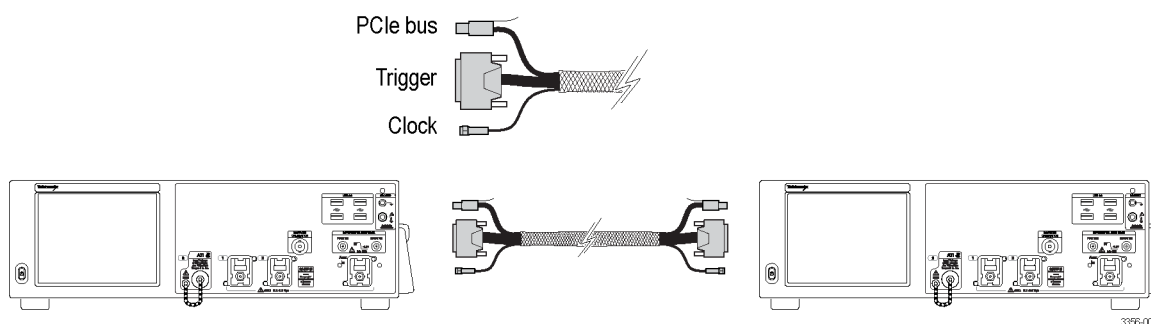

UltraSync™ bus cable connection order

Connect UltraSync bus cable bundles to the Master:

1. Select which instrument will be the Master instrument.

At the Master instrument connect each UltraSync cable bundle set to the designated ports (start with the To Extension B ports; then if connecting a third instrument use the To Extension C ports, and then if connecting a fourth instrument use the To Extension D ports):

2. Connect the clock cable to the 12.5 GHz Clock Out connector (8 in-lbs torque).
3. Connect the Trigger cable to the Trigger connector.
4. Connect the PCIe cable to the PCIe connector.

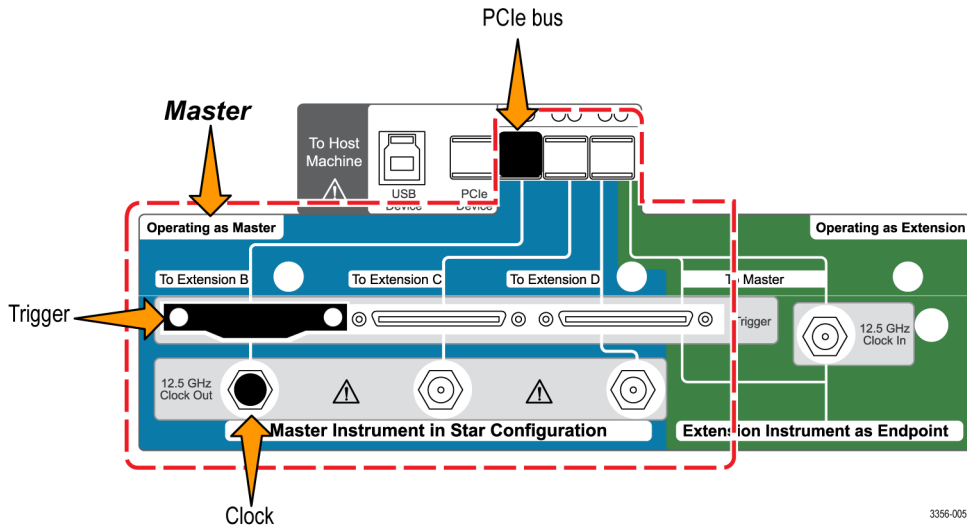

Connect UltraSync bus cable bundles to the Extension.

At the Extension, connect each UltraSync cable bundle set to the designated ports:

1. Connect the clock cable to the 12.5 GHz Clock In connector (8 in-lbs torque).
2. Connect the trigger cable to the To Master Trigger connector.
3. Connect the PCIe cable to the PCIe connector

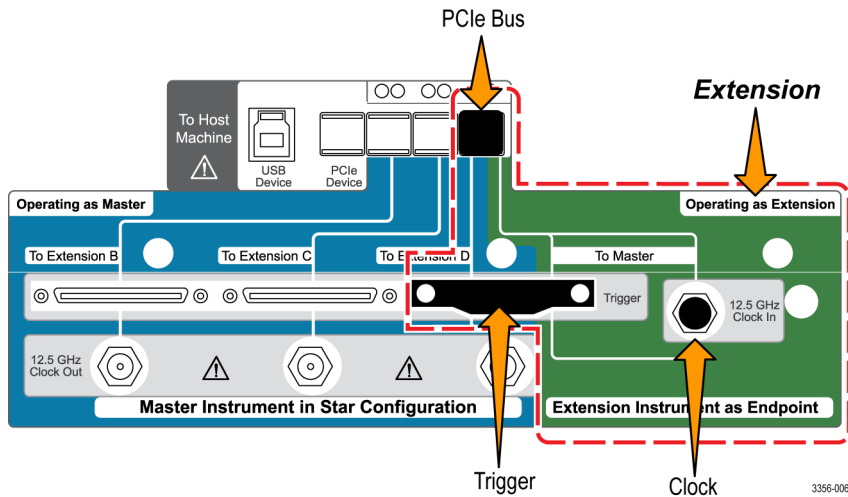

Master and extension connection order

Connect each extension instrument to the master instrument sequentially from left to right (Extension B, C, and then D).

NOTE. Connect the extensions to the master in a star pattern, do not daisy chain the instruments.

Master

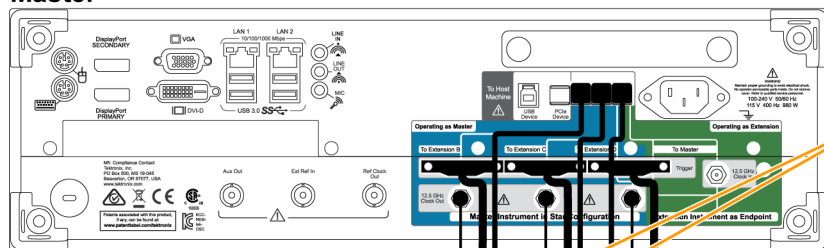

Required for 2 instrument configuration

Required for 3 instrument configuration

Required for 4 instrument configuration

Extension B

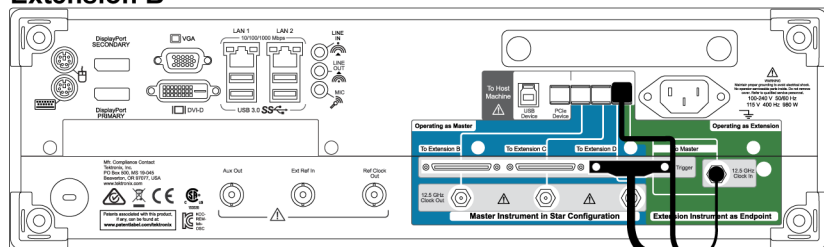

Extension C

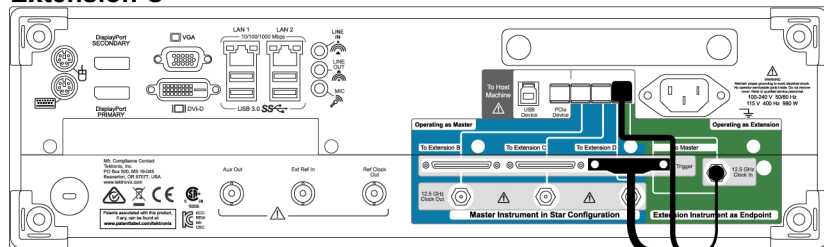

Extension D

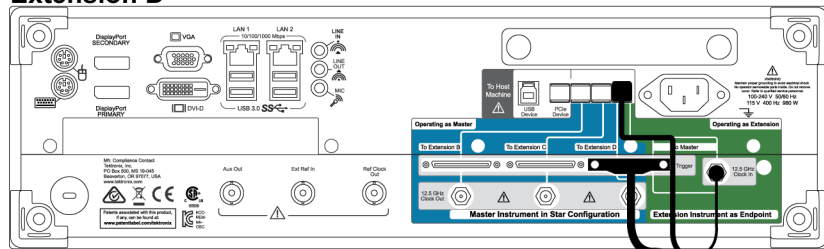

3356-009

If powering off a multi-instrument system, power off the master first.

Multi-instrument power on

During the start-up process the instrument checks to see if instruments are connected in a Multi-instrument configuration. If instruments are not connected, the instrument powers up in stand-alone mode. If instruments are connected, the configuration is validated. If the configuration is not valid, guidance is provided to help you create a valid configuration.

NOTE. After successful power on of your multi-instrument system, wait for the warm-up time to complete, and then run *Signal Path Compensation*.

The following image shows an extension with a connection that is invalid and provides guidance to correct the connection (provide the missing connection to the master).

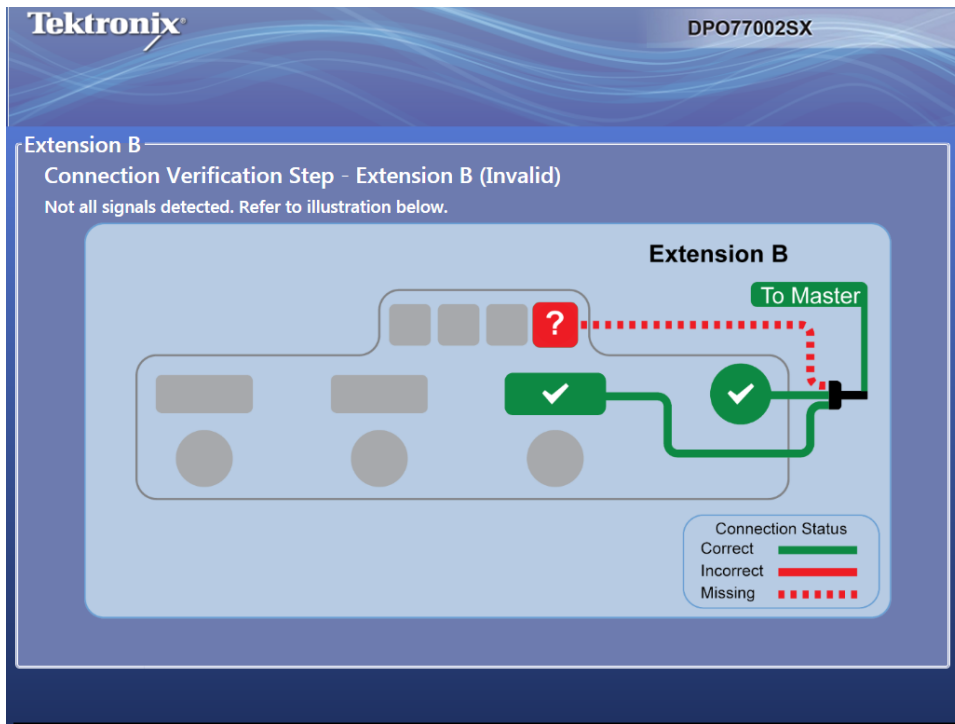

The following image shows a master connected incorrectly and provides guidance to fix the problem (provide the missing connection to the extension).

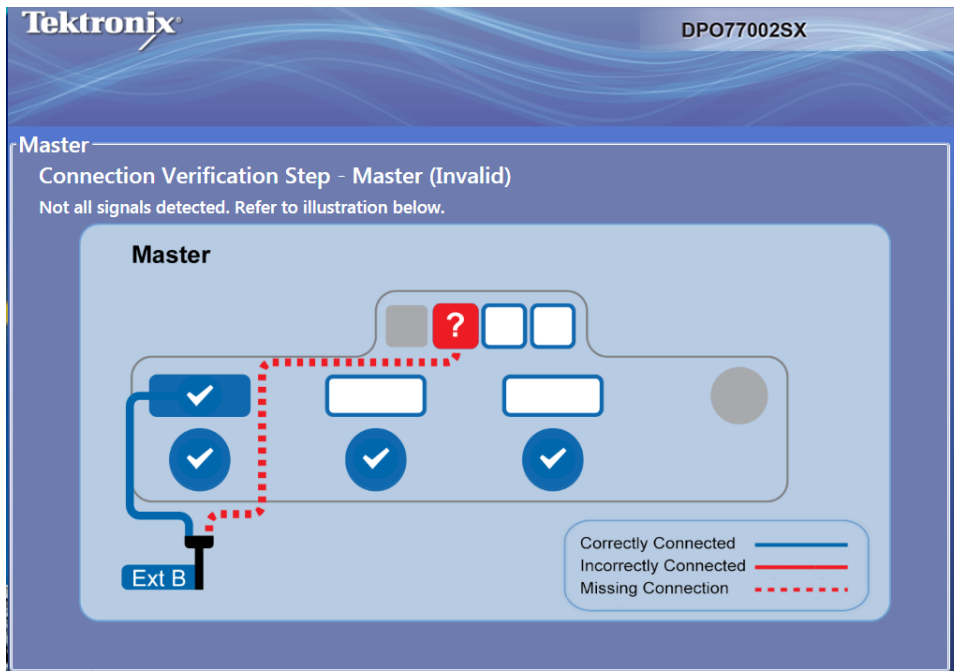

The following images show the master and extension with valid connections.

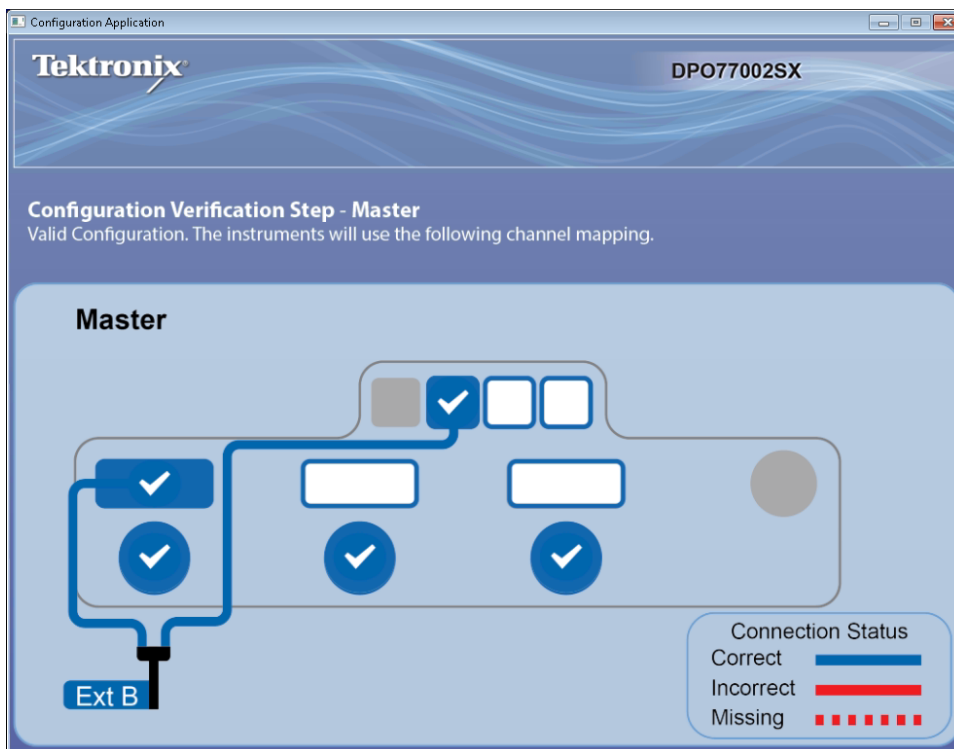

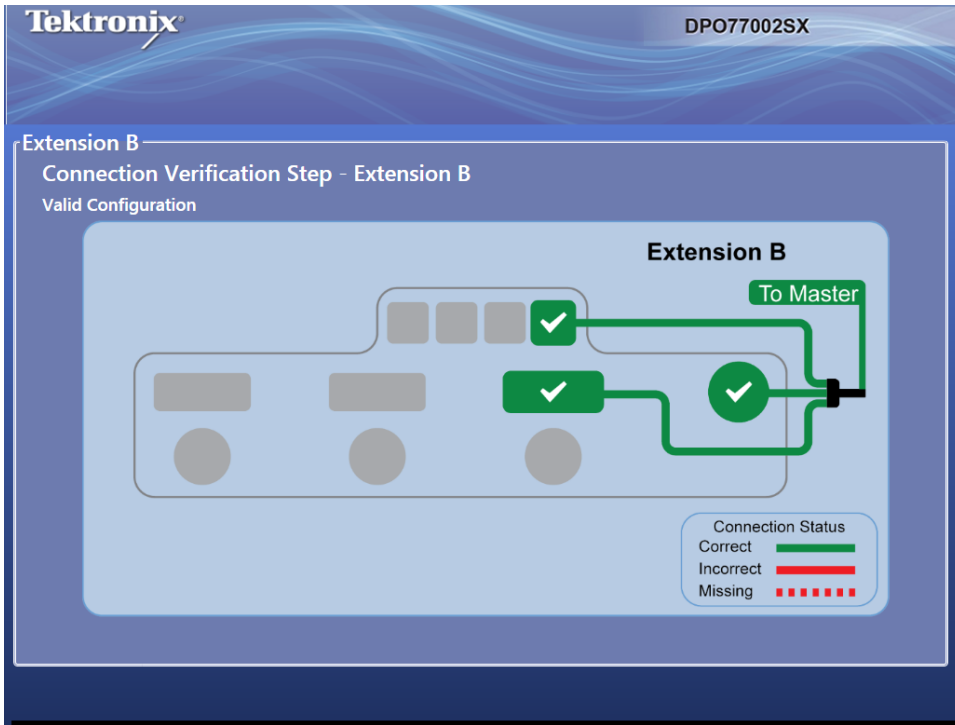

After the multi-instrument connections are verified and the instruments display their operating status displays, the master displays its status and timer display. Pause the timer if you have additional changes to make before the oscilloscope application starts. Press Start Scope to bypass the timer. When the timer runs down, the oscilloscope application starts.

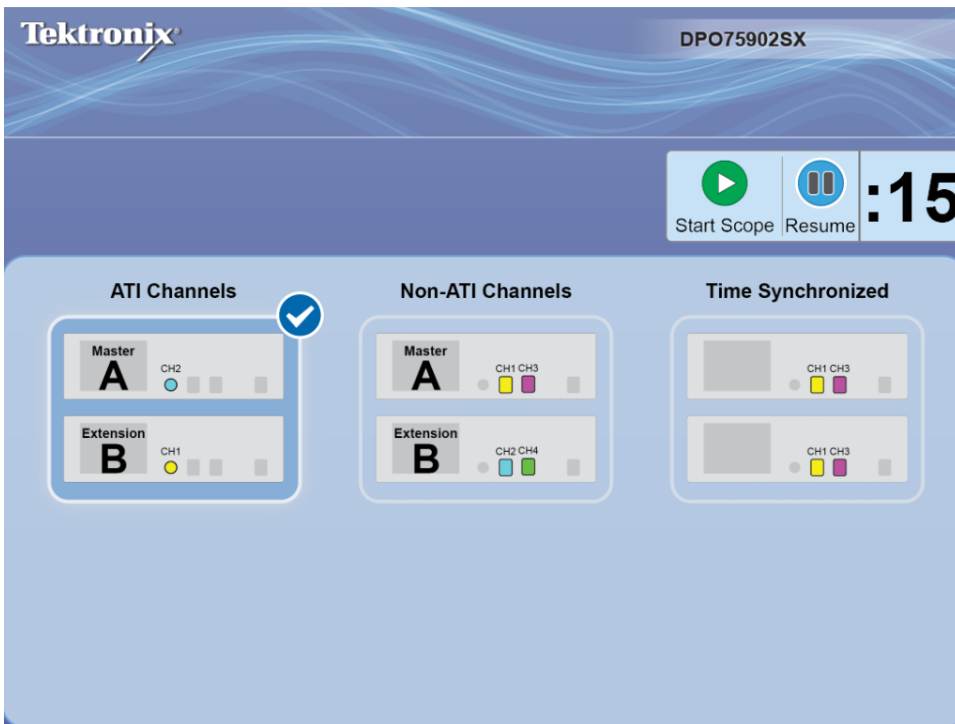

If your multi-instrument configuration includes ATI instruments, you have the opportunity to select either ATI Channels or non-ATI (TekConnect) Channels. In this example ATI Channels are selected.

NOTE. You also have the option to select **Time Synchronized** mode of all TekConnect channels. In this mode acquisitions are time synchronized and the Master controls the horizontal, record length, and trigger settings of all TekConnect channels. To ensure all channels are synchronized, operate the multi-instrument configuration in single sequence mode. Retrieve all TekConnect channel data using programmable interface commands. Waveform data is not sent to the Master. If you plan to use Time Synchronized mode, contact your Tektronix representative for additional information.

After the multi-instrument connections are verified, the instruments display their operating status displays. In this example the Master (A) is acquiring on channel 2 (ATI). The Extension (B) is acquiring on channel 2 (ATI) and is displayed as channel 1.

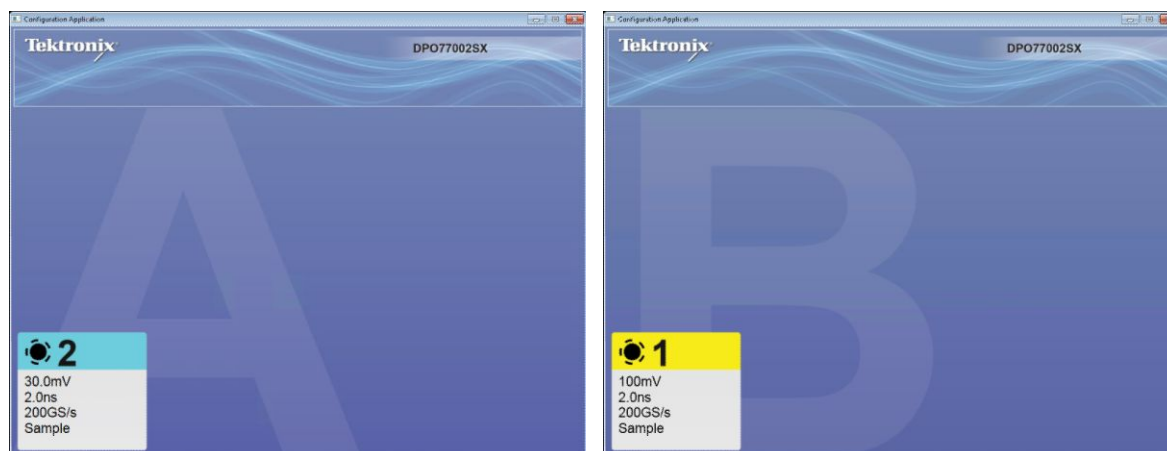

The master display identifies itself as the Master and identifies the channels being acquired.

To switch between the Configuration Application and the oscilloscope display (on the oscilloscope), use Alt-Tab. To close the Configuration Application, click the x. If the x is not visible, make the x visible by double clicking in the upper right hand corner of the Configuration Application.



3357-080

After the multi-instrument system powers on, perform a signal path compensation. See [Signal path compensation](#) on page 26.

Switching between multi-instrument modes

To switch among ATI channels, TekConnect channels, and Time Synchronized modes, use the following procedure:

1. From the Vertical > Configuration menu select either ATI, TekConnect, or TimeSync.

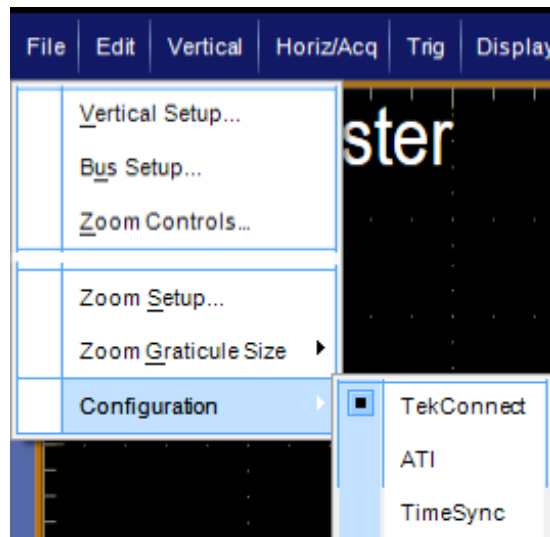

2. Click Yes to continue.

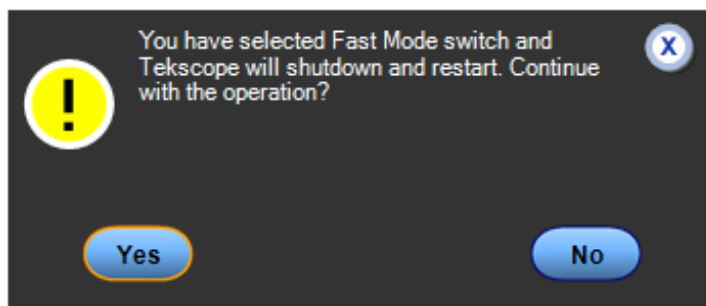

Restart of a multi-instrument system. To restart your multi-instrument system without powering down the oscilloscopes, do the following step:

1. To shut down the Configuration Manager and all of the Scope applications and then restart them without changing the configuration mode, select File > Restart.

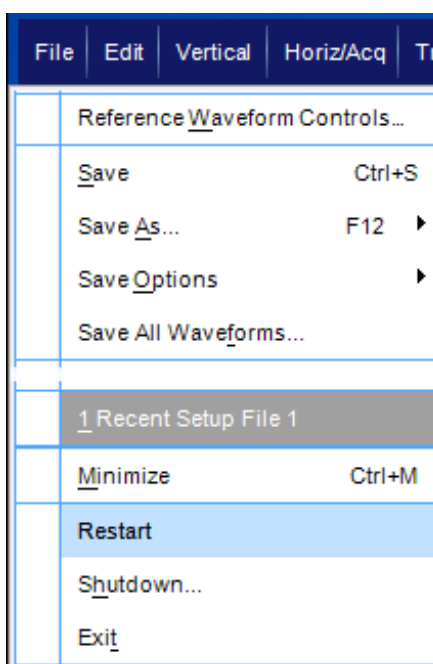

ATI versus TekConnect channels

ATI channels provide up to 70 GHz bandwidth and 200 GS/s sample rate and the lowest noise. When using the ATI channel, the TekConnect channels are not available.

TekConnect channels have up to 33 GHz bandwidth and 100 GS/s sample rate. TekConnect channels offer multiple connection options with TCA adapters, and are compatible with a wide range of performance probes.

Multi-instrument status displays

In a multi-instrument configuration, the display shows status information such as: channel numbers, on/off, run/stop, Arm/trig'd, and UltraSync connectivity information. The master instrument also displays the trigger setup and the channels being acquired and displayed.

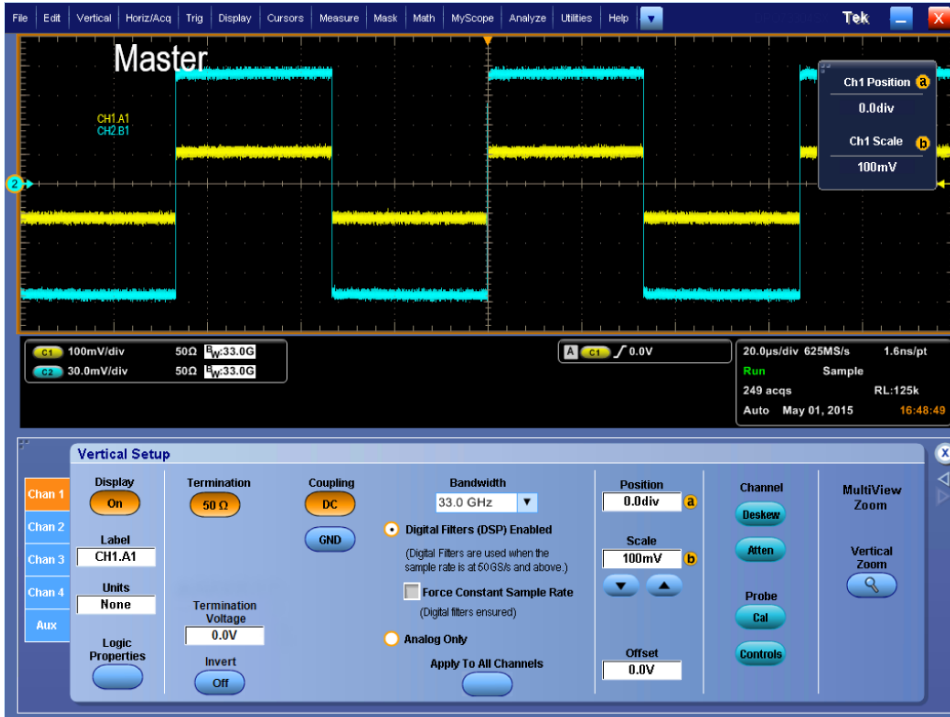

3357-080

Available features

Features discussed in this manual that are available on some instruments or configurations are noted in the tables.

Table 5: Stand-Alone instrument

Feature	DPO77002SX	DPO75902SX	DPO75002SX	DPO73304SX	DPO72304SX
State (Clocked Pattern) trigger	Available on TekConnect channels	Available on TekConnect channels	Available on TekConnect channels	Available	Available
XYZ mode	Available on TekConnect channels	Available on TekConnect channels	Available on TekConnect channels	Available	Available
Equivalent time acquisitions	Available on TekConnect channels	Available on TekConnect channels	Available on TekConnect channels	Available	Available
HiRes and peak detect	Available on TekConnect channels	Available on TekConnect channels	Available on TekConnect channels	Available	Available
FastAcq	Available on TekConnect channels	Available on TekConnect channels	Available on TekConnect channels	Available	Available

Feature	DPO77002SX	DPO75902SX	DPO75002SX	DPO73304SX	DPO72304SX
Roll mode	Available on TekConnect channels	Available on TekConnect channels	Available on TekConnect channels	Available	Available
IRE and MV graticule modes	Available on TekConnect channels	Available on TekConnect channels	Available on TekConnect channels	Available	Available

DPO7AFP Auxiliary Front Panel (optional)

The DPO7AFP is an optional plug-in panel that provides physical knobs and buttons to control the DPO70000SX series oscilloscope. To connect the DPO7AFP:

1. Close the TekScope application.

NOTE. The TekScope application must be closed before connecting the DPO7AFP.

2. Plug the DPO7AFP into any USB port on the DPO70000SX. Wait until the Windows OS recognizes and loads the required drivers.
3. Start the TekScope application. The panel LEDs will light when TekScope connects to the panel.
4. To verify that the DPO7AFP is working, push any channel button and observe that the TekScope application enables or disables the selected channel

NOTE. If you unplug the DPO7AFP while TekScope is running, you will need to close TekScope, reconnect the DPO7AFP, and restart TekScope to use the DPO7AFP.

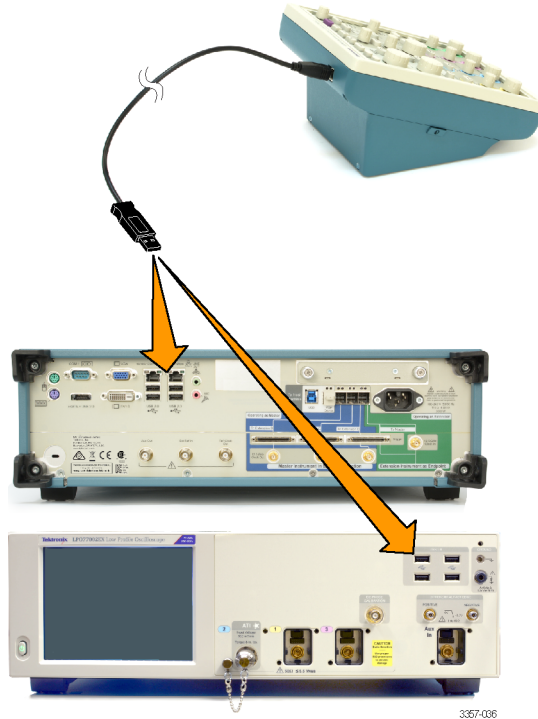

Inspect the instrument

Every time you power on the instrument, the instrument automatically performs the power-on self test diagnostics.

Verify internal diagnostics pass

Use the following procedures to verify the functionality of your instrument.

1. Power on the instrument.
2. Select Instrument Diagnostics...

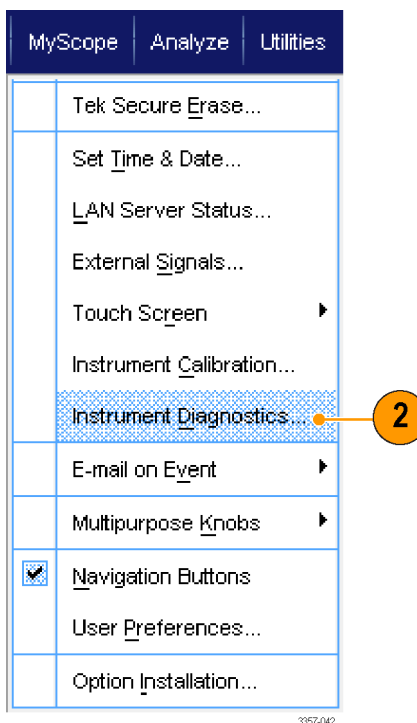

3. Click Run. The test results appear in the diagnostics control window.
4. Verify that all tests pass. If diagnostic failures occur, contact your local Tektronix service personnel.

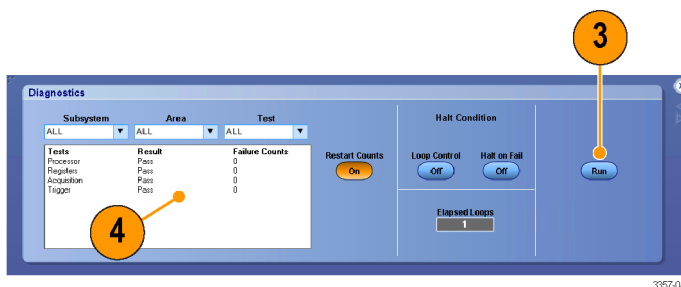

Windows interface guidelines

Because the instrument uses the Microsoft Windows interface, you have open access to the Windows operating system. You can access the Windows desktop to load and run other Windows-based applications such as Microsoft Excel.

Follow these guidelines to avoid making operating system changes that might cause problems while using the instrument:

- Be careful when making changes in the Control Panel. Avoid making changes to any controls with which you are unfamiliar.
- Do not delete or change any system fonts; this can affect the quality of the display.
- Be careful when making changes to the system Display properties. Changing settings such as resolution, text size, fonts, and orientation affects the usability of the display and the touchscreen.
- Do not change the contents of the Windows folder or the Program Files\Tektronix\AWG70000\ folder.
- Do not change the BIOS settings; this can affect the overall operation of the instrument.

Signal path compensation

Perform the Signal Path Compensation (SPC) regularly to ensure that your measurements have the highest level of accuracy. Tektronix considers it a best practice to run SPC when using the instrument to measure signals with higher sensitivity (10 mV/div and lower) settings regardless of temperature shift or time since it was last run. Failure to perform SPC may result in the instrument not meeting warranted performance levels.

SPC corrects for DC inaccuracies caused by temperature variation or by long-term drift. SPC optimizes the acquisition system, corrects DC offset, and interleaves calibration. SPC is adversely affected by input signals with AC components.

Use this procedure to optimize the acquisition system:

- If the temperature has changed more than 5 °C (9 °F) since the last signal path compensation (SPC)
- If using the instrument to measure signals with higher sensitivity (10 mV/div and lower) run SPC at least once a week
- If the front panel SPC status icon is not green
- If you replace or insert drive media
- If you change the configuration of your multi-instrument system, such as changing which instrument is the master or an extension.

1. Prerequisites:

- Instrument must be powered on until Utility > Instrument Calibration > Temperature Status is Ready.
- All channel input signals must be removed.
- If the timebase external reference mode is selected, leave the external reference signal connected and active.

2. Select Instrument Calibration.

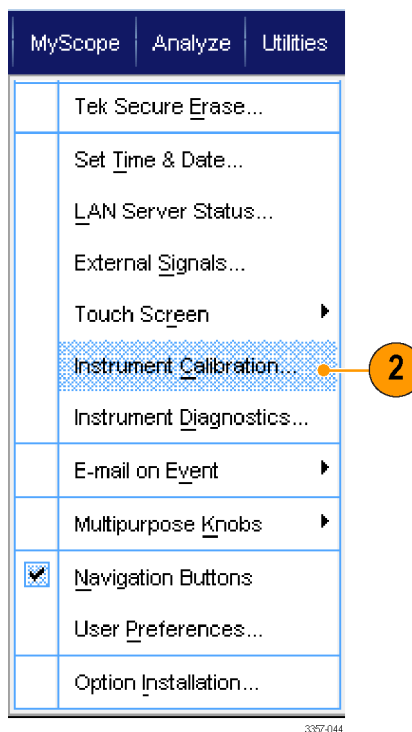

Utility menu on DPO70000SX

instruments

- When the Temperature Status changes to Ready, click Run SPC to start the calibration. Calibration may take 10 to 15 minutes.

NOTE. Before running the SPC calibration, remove all channel input signals.

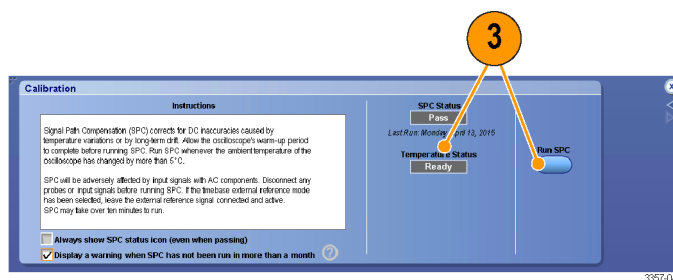

Calibration menu on DPO70000SX instruments

NOTE. If you use a drive that has not had SPC run while in the current instrument, you will see a no prior SPC warning message. If you see this warning, run SPC.

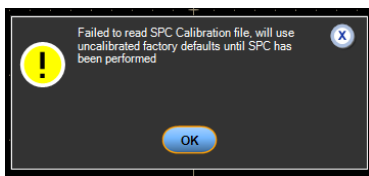

- If the instrument does not pass, recalibrate the instrument, or have the instrument serviced by qualified service personnel.

NOTE. To always show the SPC status icon or display a warning when SPC has not been run in more than a month, click the corresponding check box.

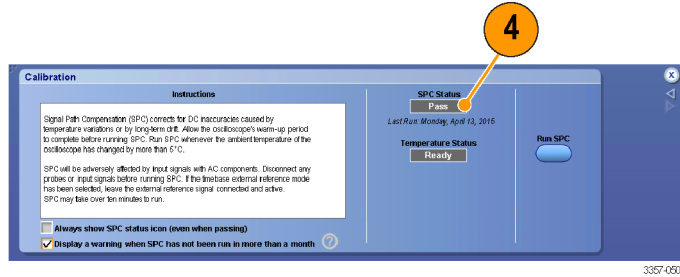

Calibration menu on DPO70000SX instruments

- If the SPC needed icon is red, perform a signal path compensation.

Check the color of the SPC Status icon:

- Green indicates that SPC successfully passed and the temperature is stable.
- Yellow indicates that the instrument is in the warm up state or that it has been over 30 days since SPC was last run.
- Red indicates that SPC needs to be run (the temperature has varied more than 5 °C, SPC failed, or SPC has not been run).

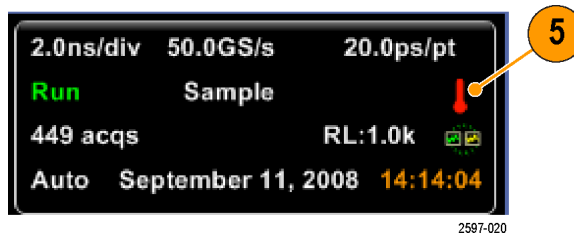

Connecting to a network

Connect your instrument to a network for printing, file sharing, internet access, and other functions. Consult with your network administrator and use the standard Windows utilities to configure the instrument for your network.

Use the Remote Desktop Connection of Windows to control and view the instrument remotely.

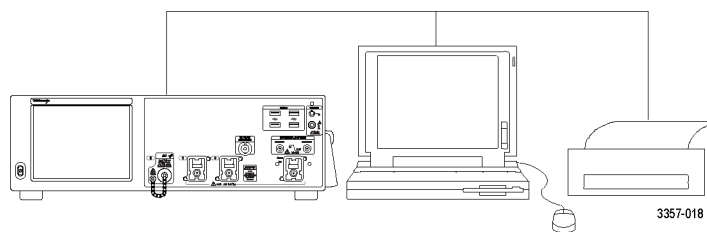

Adding a second monitor

You can operate the instrument while using Windows and installed applications on an external monitor. Follow the procedure below to set up a dual monitor configuration.

1. Turn power off.
2. Connect second monitor.
3. Connect keyboard.
4. Connect mouse.
5. Turn instrument power on.
6. Turn monitor power on.

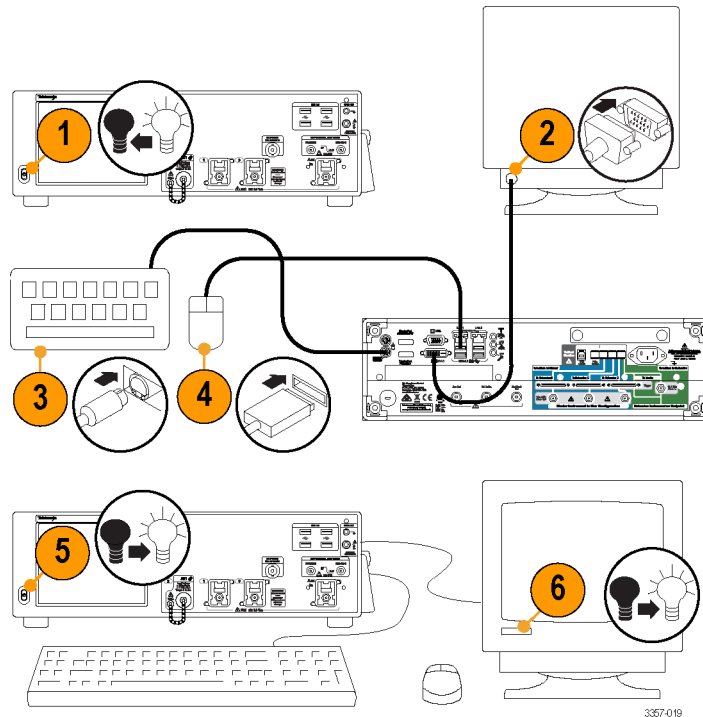

Restoring instrument operating system and product software

You can restore the instrument's Windows Operating System directly from the instrument. The instrument does not ship with an operating system restore disc.

To restore or update the product software, you need to download the current version from the Tektronix web site.

NOTE. Restoring or updating the product software does not require that you restore the Windows operating system.

Operating system restore



CAUTION. Using the restore process reformats the hard drive and reinstalls the operating system. All saved data is lost. If possible, save important files to external media before performing a system restore.

The Windows operating system installed is designed for this instrument's hardware and product software. Installing a version other than the one provided will not function properly.

After the operating system is installed, you need to download the product software installation package from the [Tektronix web site](#) and reinstall the software.

Internal recovery utility

This is the preferred method to restore a damaged Windows Operating System. This method restores the Windows Operating System using the Acronis Startup Recovery Manager. The Acronis software reinstalls the operating system using restore images preinstalled on the hard drive.

This method retains the restore images, providing the ability to repeat the restore process.

1. Attach the keyboard to the instrument.
2. Restart the instrument. During the boot-up process you will see the following message at the top of the screen:
Starting Acronis Loader... press F5 for Acronis Startup Recovery Manager

NOTE. To successfully complete the system restore, you must use the Windows version of the Acronis software. Using a generic MAC keyboard starts the DOS version of the Acronis software. Do not use a MAC keyboard.

3. Repeatedly press the F5 key until the Acronis True Image Tool opens. There is a 15-second time period from when the message appears until the instrument proceeds with the normal instrument startup. If the instrument does not open the Acronis application, power off the instrument, then power on the instrument and try again.
4. Click Restore.
5. In the Confirmation dialog box, click Yes to restore the instrument operating system, or No to exit the restore process. The restore process takes approximately 30 minutes; the actual time depends on the instrument configuration.

Product software installation

NOTE. For DPO77002SX instruments you must order the product software from Tektronix.

1. Download the product software installation package. The installation package contains:
 - Instructions
 - Product software installer
2. Install the product software following all on-screen prompts.

Getting acquainted with your instrument

Front-panel connectors

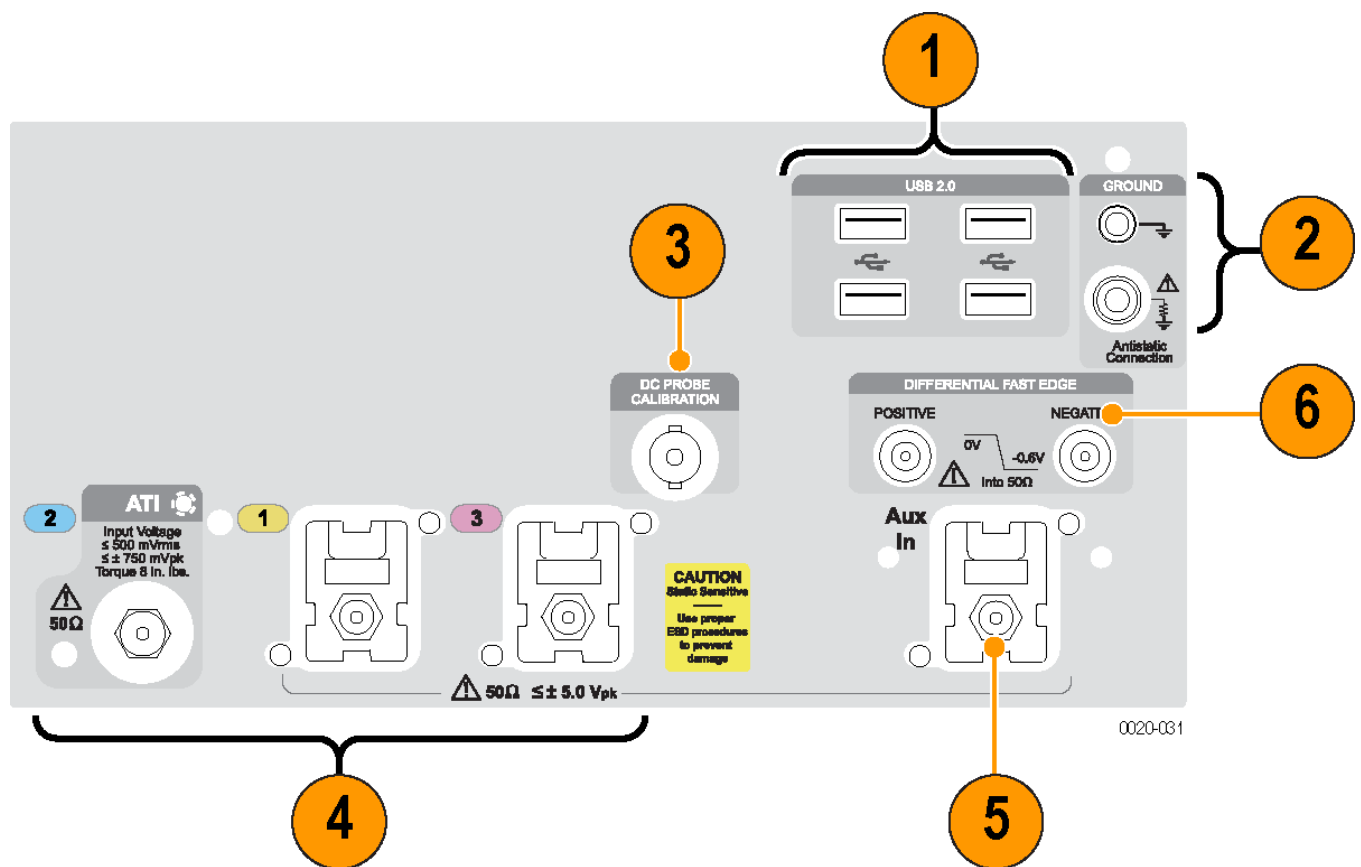

Figure 5: ATI with TekConnect channels

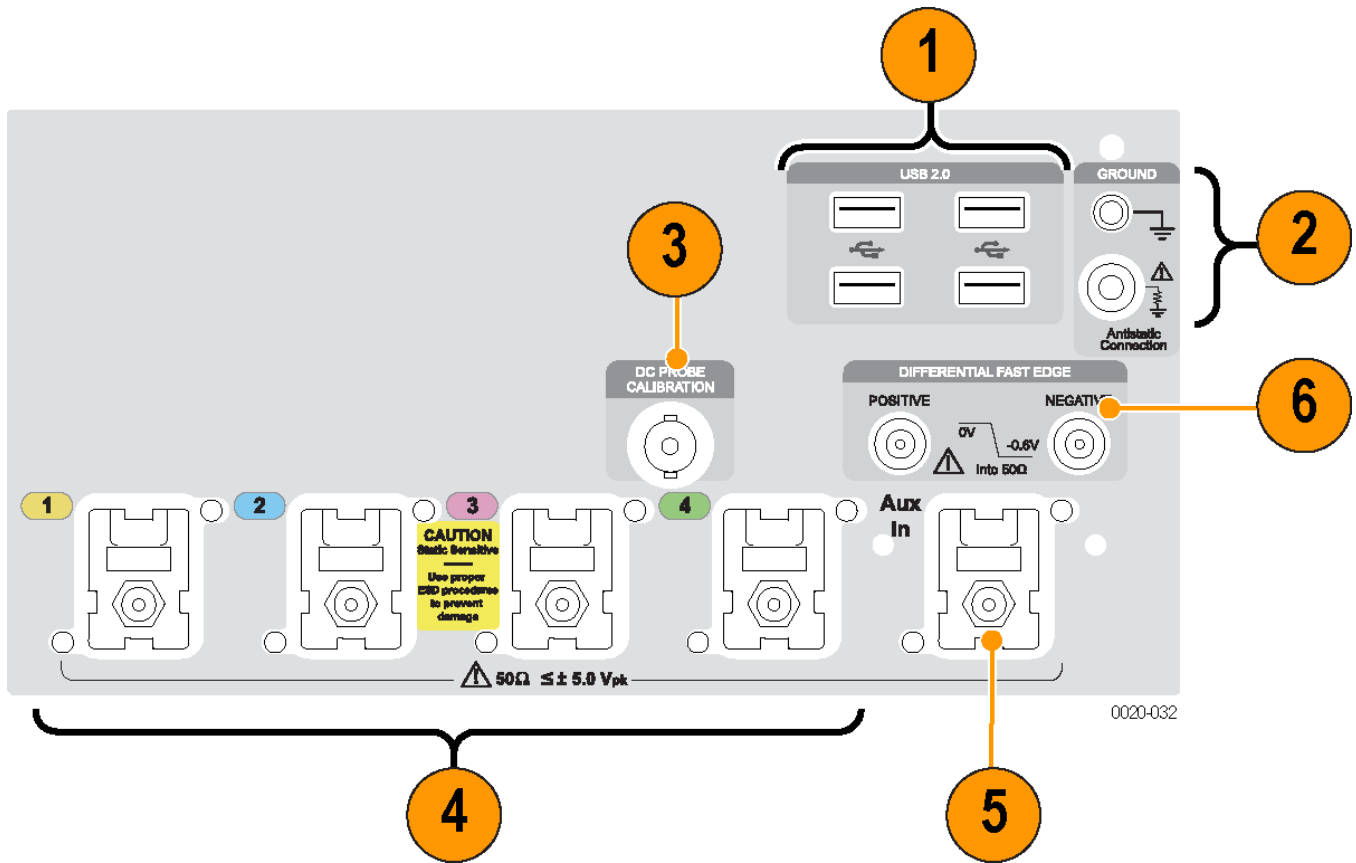
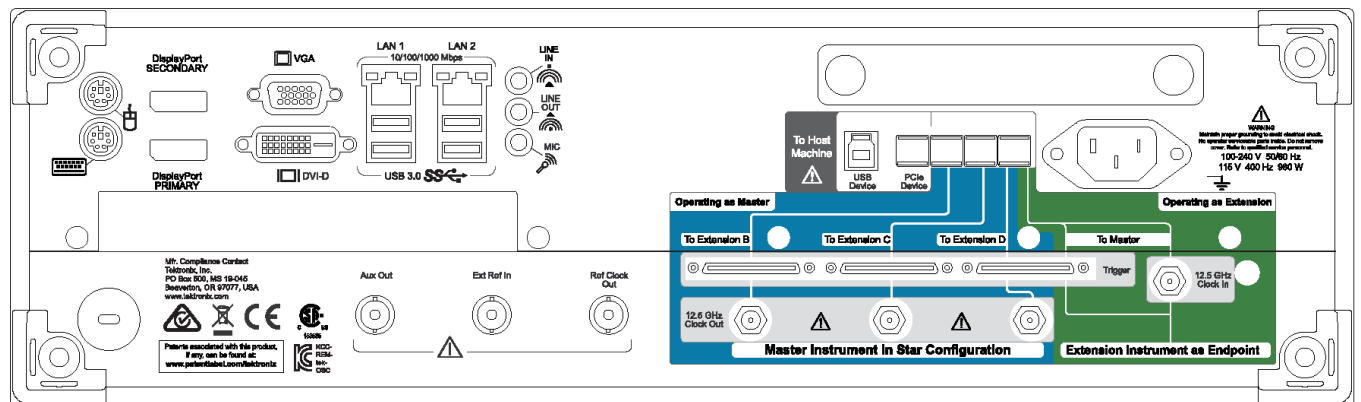

Figure 6: TekConnect channels

Table 6: Front-panel connectors

Identifier	Connector	Description
1	USB 2.0	Four USB connectors.
2	Chassis ground	Banana type ground connection.
	Ground through 1 MΩ resistor	Banana type ground connection. Discharge the static voltage from your body by wearing a grounded antistatic wrist strap while connecting and disconnecting cables and TekConnect adapters.
3	DC Probe Calibration	Probe calibration output
4	1, 2, 3, and 4(Analog inputs)	These connectors supply analog signals.
5	Aux In	Auxiliary trigger input
6	Differential Fast Edge	Differential fast edge step output.

Rear-panel connectors



336E-003

Table 7: Rear-panel connectors

Connector	Description
PCIe	PCIe port to connect external devices or to configure multi-instrument systems.
12.5 GHz Clock In	SMA type connector to provide an external clock signal used in multi-instrument configurations.
12.5 GHz Clock Out	SMA type connector to provide a high speed clock that is related to the sample rate. This clock is used in multi-instrument configurations.
Trigger	UltraSync trigger bus.
LAN	RJ-45 connectors to connect the instrument to a network.
USB 3.0	Four USB 3.0 Host connectors (type A) to connect devices such as a mouse, keyboard, or other USB devices. Tektronix does not provide support or device drivers for USB devices other than the supplied mouse and keyboard.
USB	USB device connector
VGA	VGA port to connect a monitor for extended desktop operation. To connect a DVI monitor to the VGA connector, use a DVI-to-VGA adapter.
DVI-D	Use the DVI-D Video port to send the instrument display to a projector or to a flat-panel LCD monitor.
Display port	These connectors provide digital display interfaces
PS/2 mouse	This connector is for a PS/2 mouse.
PS/2 keyboard	This connector is for a PS/2 keyboard
Audio	These connectors provide microphone input, line in, and line out.
Auxiliary output	SMA type connector provides a TTL-compatible, negative polarity pulse when the instrument triggers or when certain other events occur, such as a mask test failure or completion.
Reference output	SMA type connector to provide a synchronization signal to external devices.
External reference input	SMA type connector to provide an external reference clock input.
Power	Power cord input.

Interface and display

The menu bar mode provides access to commands that control all of the instrument features and functions. The toolbar mode provides access to the most common features.

1. **Menu Bar:** Access to data I/O, printing, online help, and instrument functions
2. **Buttons/Menu:** Click to toggle between toolbar and menu bar modes and to customize your toolbar
3. **Multipurpose Knob Readouts:** Adjust and display parameters controlled by the multipurpose knobs
4. **Display:** Live, reference, math, and bus waveforms display here, with cursors
5. **Waveform Handle:** Click and drag to change vertical position of a waveform or bus. Click the handle and change the position and scale using the multipurpose knobs.
6. **Controls Status:** Quick reference to vertical selections, scale, offset, and parameters. Probe status is provided for some probe tips.
7. **Readouts:** Display cursor and measurement readouts in this area. Measurements are selectable from the menu bar or toolbar. If a control window is displayed, some combinations of readouts move to the graticule area.

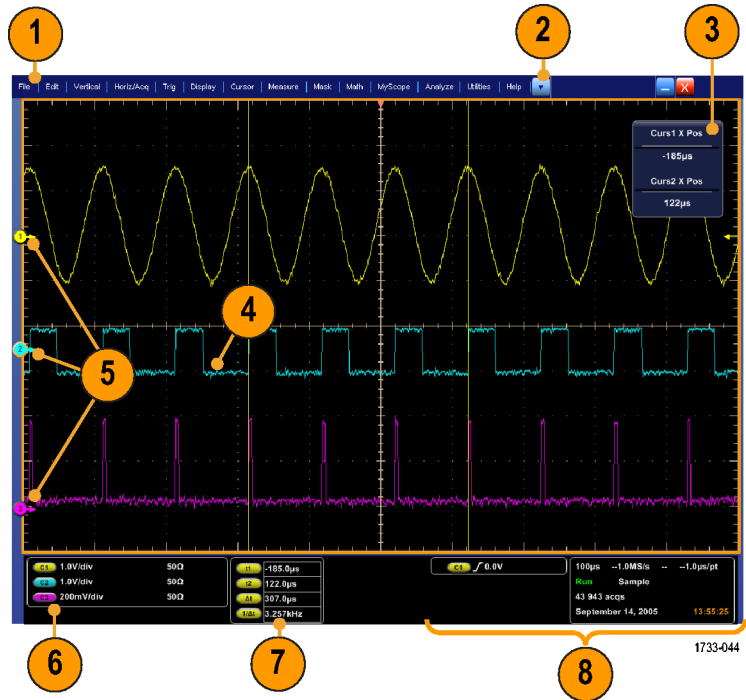

WARNING. If there is vertical clipping, there may be a dangerous voltage on the probe tip, but the readout will indicate a low voltage. A  symbol appears in the measurement readout if a vertical clipping condition exists. Automatic amplitude-related measurements where the signal is vertically clipped produce inaccurate results. Clipping also causes inaccurate amplitude values in waveforms that are stored or exported for use in other programs. If a math waveform is clipped, it will not affect amplitude measurements on that math waveform.

8. **Status:** Display of acquisition status, mode, and number of acquisitions; trigger status; date; time; and quick reference to record length and horizontal parameters

1. **Buttons/Menu:** Click to toggle between toolbar and menu bar modes and to customize the toolbar
2. Drag cursors to measure waveforms on screen
3. Drag the position icons to reposition a waveform
4. Click the icon to assign the multipurpose knobs to waveform vertical position and scale
5. Drag across the waveform area to create a box for zooming, enabling/disabling histograms, gating measurements, and adding and controlling visual trigger areas
6. Drag icon to change the trigger level

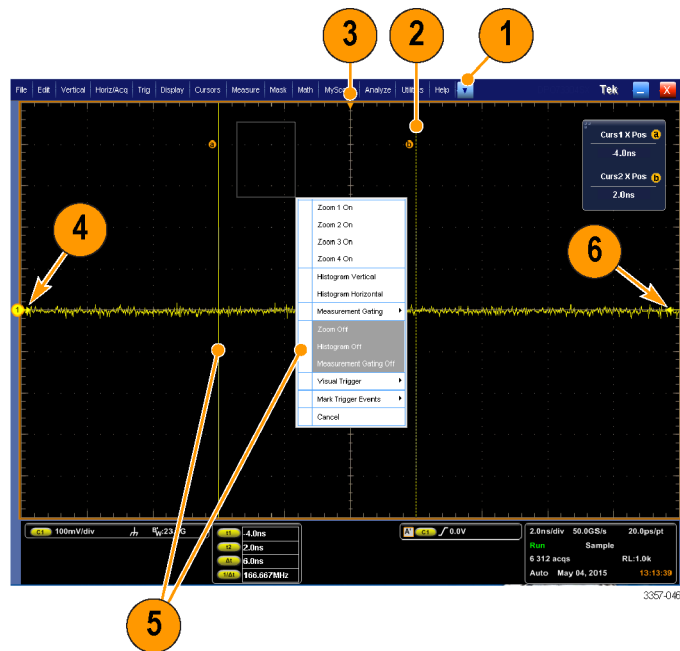

Control panel

NOTE. These controls are available on the Auxiliary Front Panel accessory. The functions these controls perform are available in the instrument menus.

1. Push to automatically set up the vertical, horizontal, and trigger controls based on selected channels.
2. Push to return settings to default values.
3. Push to make a hard copy or save a screen capture.
4. Push to turn on MultiView Zoom and add a magnified graticule to the display.
5. Horizontally scale, position, delay, and set record length (resolution) of all waveforms.
6. Use to start and stop acquisition, start a single acquisition sequence, clear data, or start fast acquisitions.
7. Use to set the trigger parameters. Push Advanced to display additional trigger functions. The Arm, Ready, and Trig'D lights show the acquisition status.
8. Turn to adjust waveform intensity.
9. Turn to adjust parameters selected from the screen interface. Push to toggle between normal and fine adjustment.
10. Push to turn cursors on or off.
11. Use to search and mark waveforms.
12. Push to turn the touch screen on and off.
13. Turn channel displays on and off. Vertically scale, position, or offset the waveform. Toggle between position and offset.

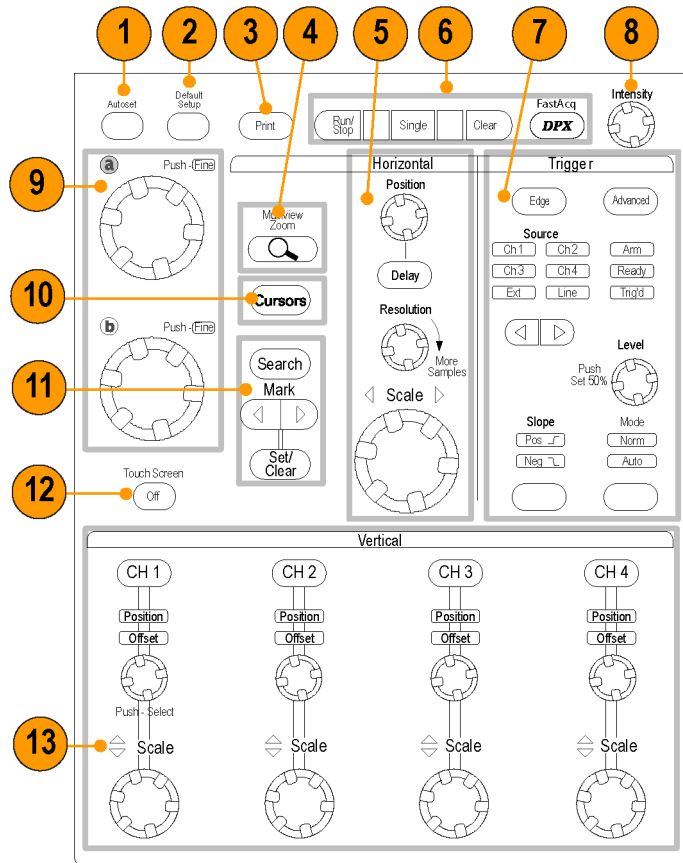

2597-006

Accessing online help

In-depth information is available in the online help on all the features of your instrument.

To access context-sensitive help on the active window, select **Help > Help on Window...** or press **F1**.

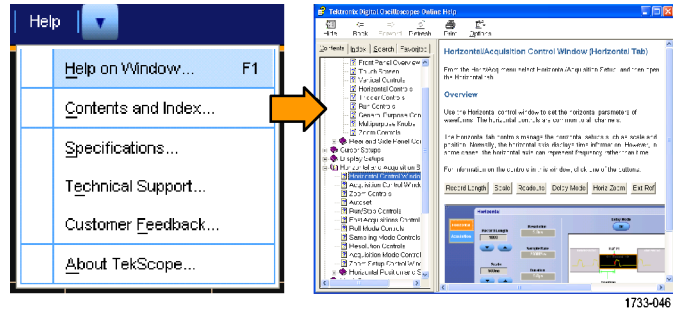

1733-046

1. To access any topic in the help system, select **Help > Contents and Index...**
2. Use the Contents, Index, Search, or Favorites tab to select the topic, and then click **Display**.

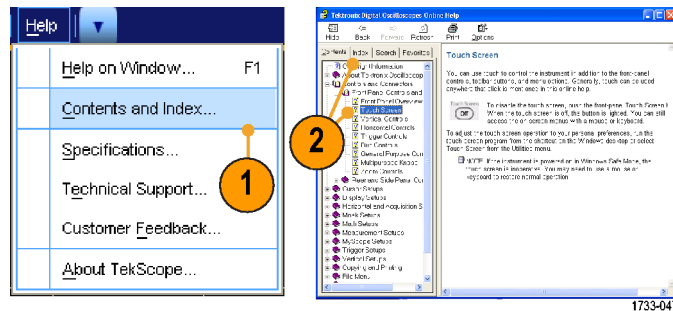

1733-047

To navigate within the help system:

- Click a button in a help window to navigate between the Overview and specific topics.
- Click the **Minimize** button in the help window to move help out of the way so you can operate the instrument.
- Click **Alt** and **Tab** to see the last help topic again.

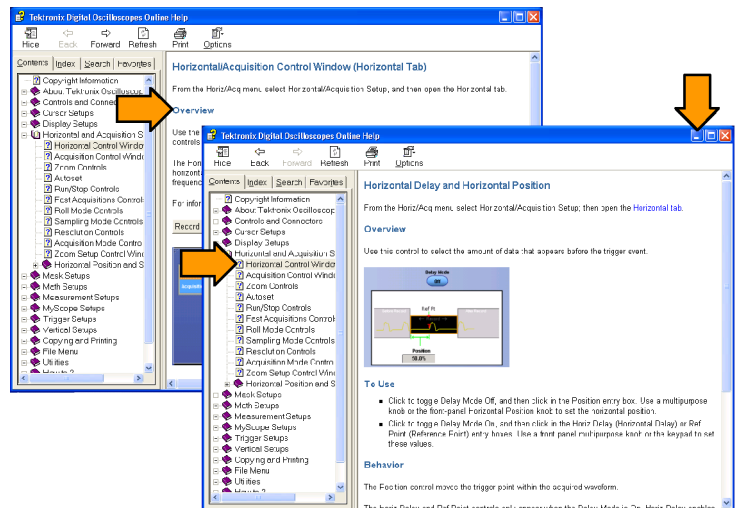

1733-048

Accessing menus and control windows

Access menus and control windows using the following techniques:

- Click a menu, and then select a command.

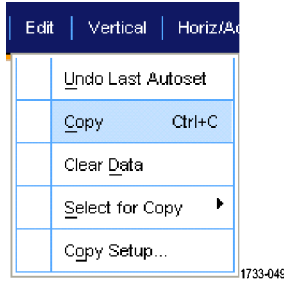

- For a shortcut menu, right-click anywhere in the graticule or on an object. The shortcut menu is context sensitive and varies with the area or object where you right-clicked. Some examples are shown in the figure at right.

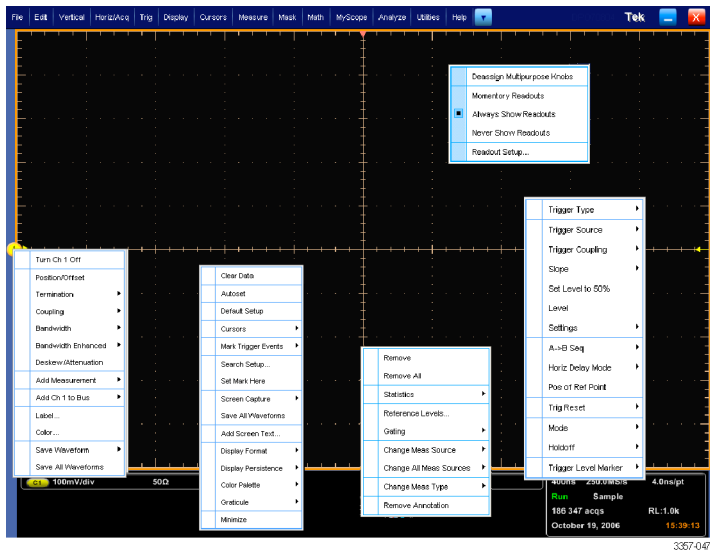

- In the toolbar mode, click a button to quickly access a setup control window. See [Interface and display](#).



Inspect your instrument

Use the following procedures to verify the functionality of your instrument.

Verify internal diagnostics pass

1. Power on the instrument.
2. Select **Instrument Diagnostics...**

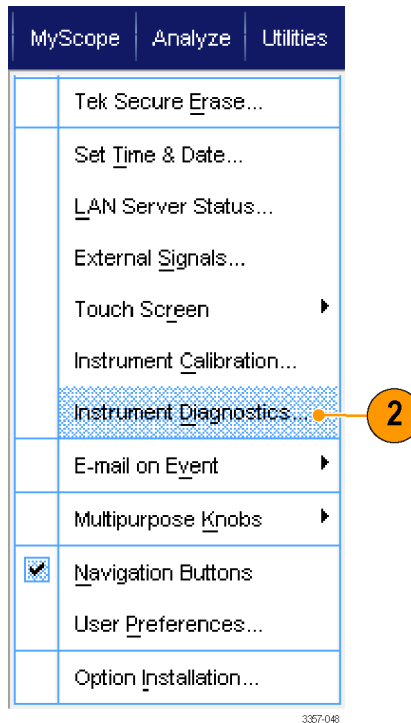

3. Click **Run**. The test results appear in the diagnostics control window.
4. Verify that all tests pass. If diagnostic failures occur, contact your local Tektronix service personnel.

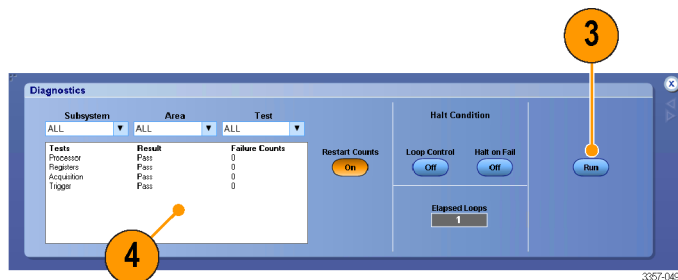

Acquisition

This section contains concepts of and procedures for using the acquisition system.

Signal path compensation

Perform the Signal Path Compensation (SPC) regularly to ensure that your measurements have the highest level of accuracy. Tektronix considers it a best practice to run SPC when using the instrument to measure signals with higher sensitivity (10 mV/div and lower) settings regardless of temperature shift or time since it was last run. Failure to perform SPC may result in the instrument not meeting warranted performance levels.

SPC corrects for DC inaccuracies caused by temperature variation or by long-term drift. SPC optimizes the acquisition system, corrects DC offset, and interleave calibration. SPC is adversely affected by input signals with AC components.

Use this procedure to optimize the acquisition system:

- If the temperature has changed more than 5 °C (9 °F) since the last signal path compensation (SPC)
- If using the instrument to measure signals with higher sensitivity (10 mV/div and lower) run SPC at least once a week
- If the front panel SPC status icon is not green
- If you replace or insert drive media
- If you change the configuration of your multi-instrument system, such as changing which instrument is the master or an extension.

1. Prerequisites:

- Instrument must be powered on until Utility > Instrument Calibration > Temperature Status is Ready.
- All channel input signals must be removed.
- If the timebase external reference mode is selected, leave the external reference signal connected and active.

2. Select Instrument Calibration.

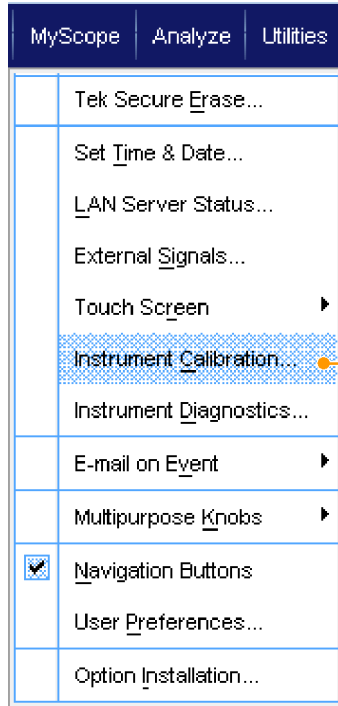

Utility menu on DPO70000SX

instruments

3. When the Temperature Status changes to Ready, click Run SPC to start the calibration. Calibration may take 10 to 15 minutes.

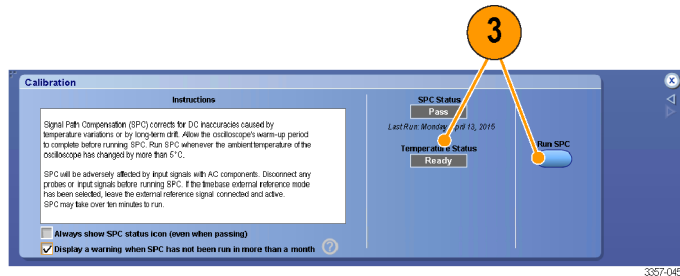

Calibration menu on DPO70000SX instruments

NOTE. Before running the SPC calibration, remove all channel input signals.

NOTE. If you use a drive that has not had SPC run while in the current instrument, you will see a no prior SPC warning message. If you see this warning, run SPC.

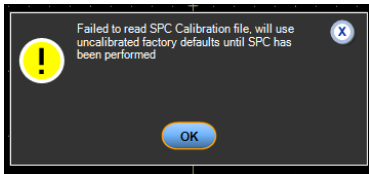

- If the instrument does not pass, recalibrate the instrument, or have the instrument serviced by qualified service personnel.

NOTE. To always show the SPC status icon or display a warning when SPC has not been run in more than a month, click the corresponding check box.

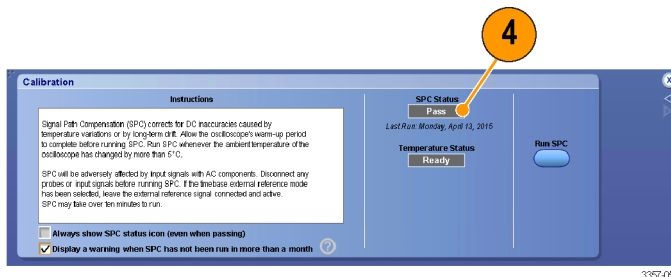

Calibration menu on DPO70000SX instruments

- If the SPC needed icon is red, perform a signal path compensation.

Check the color of the SPC Status icon:

- Green indicates that SPC successfully passed and the temperature is stable.
- Yellow indicates that the instrument is in the warm up state or that it has been over 30 days since SPC was last run.
- Red indicates that SPC needs to be run (the temperature has varied more than 5 °C, SPC failed, or SPC has not been run).

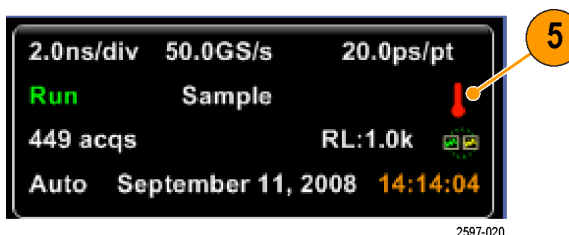

2597-020

Setting up analog signal input

Use the drop down menus or the Auxiliary Front Panel to set up your instrument to acquire the signal.

If using the drop down menus, do the following steps:

1. Connect the probe or cable to the input signal source.



CAUTION. To prevent damage to the instrument, always wear an antistatic wrist strap when making connections to the instrument and observe the maximum input voltage ratings for input connectors.

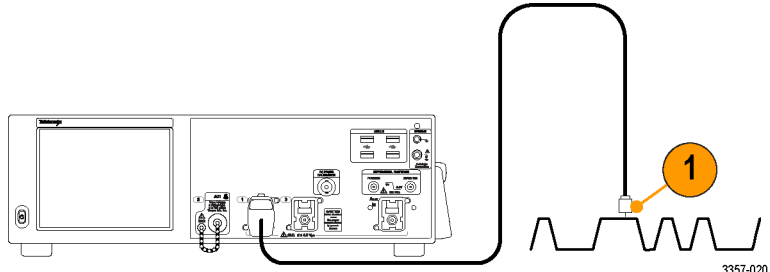

3357-020

2. Select the input channel: Select **Vertical > Vertical Setup**. Select the tab for the channel you want to select, and then press the **Display** button to toggle the channel on or off.

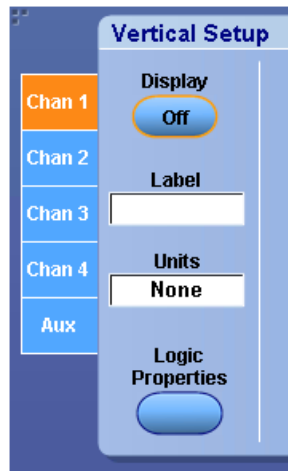

3. Select **Horiz/Acq > Autoset**.
4. Select **Vertical > Vertical Setup**. Adjust the vertical position, scale, and offset: Double click the Position, Scale, and Offset controls and use the pop-up keypad make the adjustment.

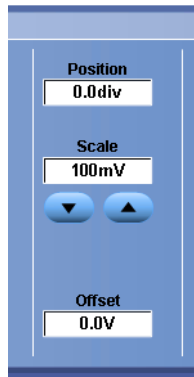

5. If you want to invert the input signal, click the **Invert** button to toggle invert on and off. The Invert button is in the Vertical Setup menu or the Deskew/Attenuation/Invert menu.

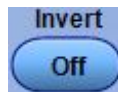

6. Select **Horiz/Acq > Horizontal/ Acquisition Setup**. Adjust the horizontal position and scale: Double click the Position and Scale controls and use the pop-up keypad to make the adjustment.

The horizontal position determines the number of pretrigger and posttrigger samples.

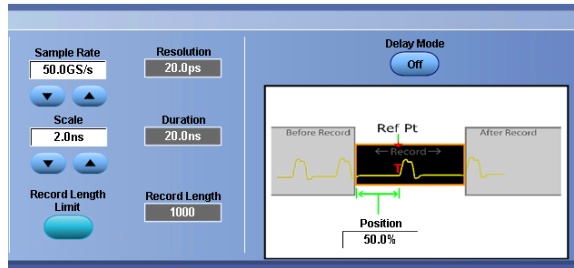

If using the Auxiliary Front Panel, do the following steps:

1. Connect the probe or cable to the input signal source.



CAUTION. To prevent damage to the instrument, always wear an antistatic wrist strap when making connections to the instrument and observe the maximum input voltage ratings for input connectors.

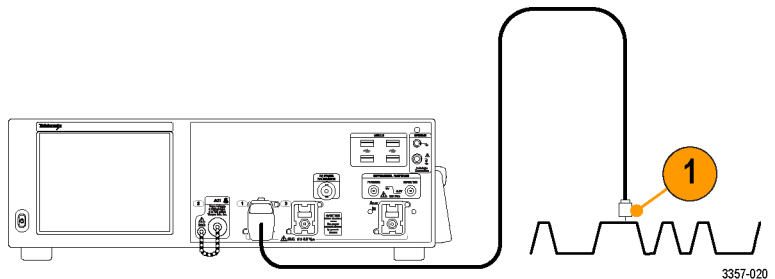

2. Select the input channel.

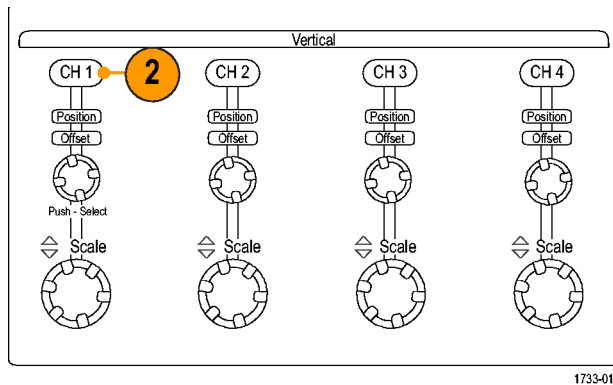

3. Select **Horiz/Acq** then Autoset.
4. Adjust the vertical position, scale, and offset.

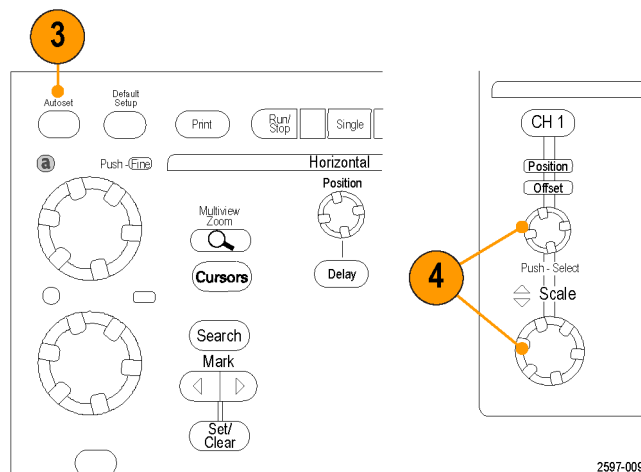

- Adjust the horizontal position and scale.

The horizontal position determines the number of pretrigger and posttrigger samples.

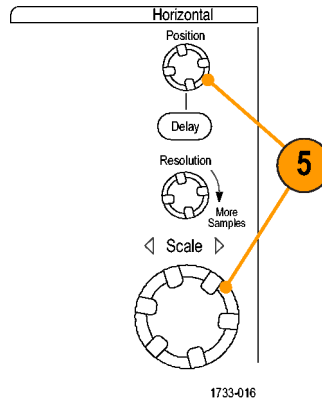

1733-016

Using default setup

- To quickly return to the factory default settings, select **Recall Default Setup** from the file menu or push **DEFAULT SETUP** on the Auxiliary Front Panel.

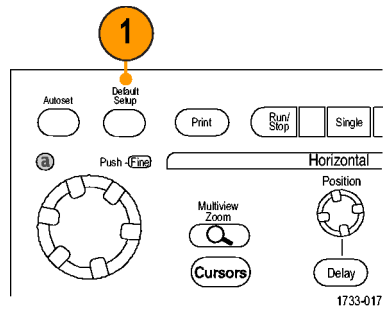

1733-017

Using autoset

Use Autoset to quickly and automatically set up the instrument (acquisition, horizontal, trigger, and vertical) based on the characteristics of the input signal. Autoset makes adjustments to the signal such that the waveform displays two or three cycles with the trigger level near the midlevel.

1. Connect the probe, and then select the input channel. See [Setting up analog signal input](#) on page 46.
2. To execute an Autoset, select **Horiz/Acq** and then **Autoset** or push the **AUTOSET** button on the Auxiliary Front Panel.

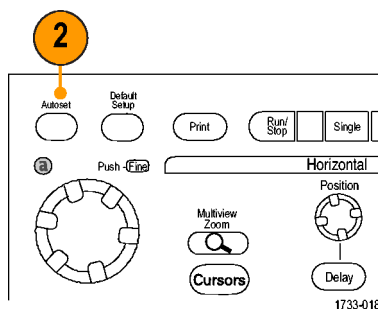

3. Click **Undo** to undo the last Autoset. Parameters that are not affected by Autoset retain their settings.

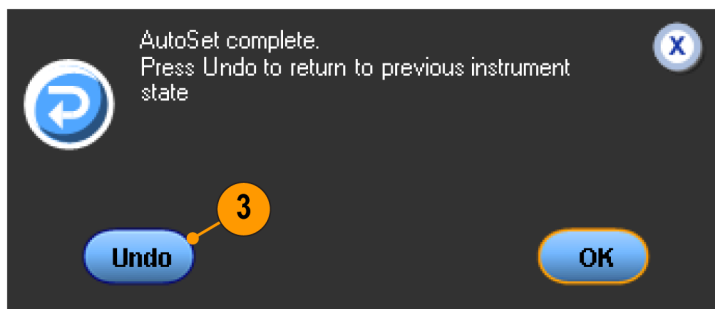

1733-058

Quick tips

- Autoset automatically sets up the analog channels.
- On instruments with iCapture, autoset automatically sets up the iCapture channels.
- To position the waveform appropriately, Autoset may change the vertical position. Autoset may also adjust vertical offset.
- If you use Autoset when one or more channels are displayed, the instrument selects the lowest numbered channel for horizontal scaling and triggering. You can individually control the vertical scaling of each channel.
- If you use Autoset when no channels are displayed, the instrument turns on channel one (Ch 1) and scales it.
- Close Autoset Undo control window by clicking the X. After Autoset Undo closes, you can still undo the last Autoset by selecting the Undo Last Autoset command from the Edit menu.
- Stop the Autoset Undo control window from opening automatically by changing the User Preferences in the Utilities menu.

Probe compensation and deskew

To optimize measurement accuracy, see the instrument online help to perform the following procedures:

- Compensate passive probes
- Compensate active probes
- Deskew input channels

Acquisition concepts

Acquisition hardware

Before a signal is displayed, it must pass through the input channel where it is scaled and digitized. Each channel has a dedicated input amplifier and digitizer. Each channel produces a stream of digital data from which the instrument extracts waveform records.

Sampling process

Acquisition is the process of sampling an analog signal, converting it into digital data, and assembling it into a waveform record, which is then stored in acquisition memory.

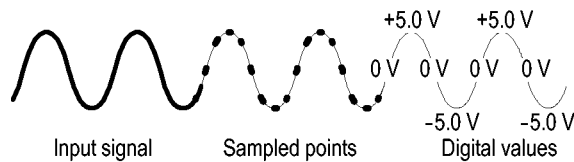

Real-Time sampling

In real-time sampling, the instrument digitizes all of the points it acquires using one trigger event. Use real-time sampling to capture single-shot or transient events.

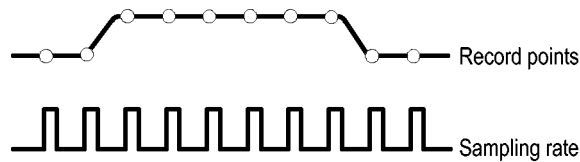

Interpolated Real-Time sampling

In interpolated real-time sampling, the instrument digitizes all of the points it acquires using one trigger event. If the instrument cannot acquire enough samples for a complete waveform at the maximum real-time sample rate, it interpolates. Use interpolated real-time sampling to capture single-shot or transient events.

Equivalent-Time sampling

The instrument uses equivalent-time sampling to extend its sample rate beyond its real-time maximum sampling rate. Equivalent-time sampling is only used if Equivalent Time is selected and the time base is set to a sampling rate that is too fast to create a waveform record using real-time sampling.

The instrument makes multiple acquisitions of a repetitive waveform to obtain the sample density required for one complete waveform record. Thus, equivalent time sampling should only be used with repetitive signals.

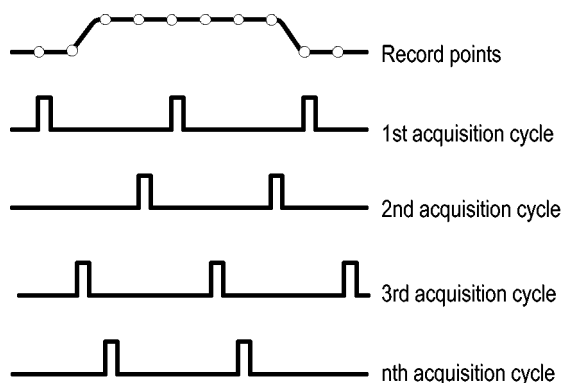

Waveform record

The instrument builds the waveform record through use of the following parameters:

- **Sample interval:** The time between sample points.
- **Record length:** The number of samples required to fill a waveform record.
- **Trigger point:** The zero time reference in a waveform record.
- **Horizontal position:** When horizontal delay is off, the horizontal position is a percentage of the waveform record between 0 and 99.9 percent. The trigger point and the horizontal reference are at the same time in the waveform record. For example, if the horizontal position is 50 percent, then the trigger point is in the middle of the waveform record. When horizontal delay is on, the time from the trigger point to the horizontal reference is the horizontal delay.

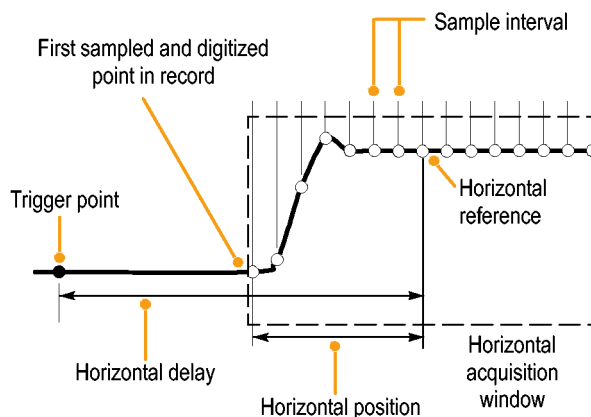

Interpolation

Your instrument can interpolate between the samples it acquires when it does not have all of the actual samples it needs to fill the waveform record. Linear interpolation computes record points between actual acquired samples by using a straight line fit.

Sin(x)/x interpolation computes record points using a curve fit between the actual values acquired. Sin(x)/x interpolation is the default interpolation mode because it requires fewer actual sample points than linear interpolation to accurately represent the waveform.

How the acquisition modes work

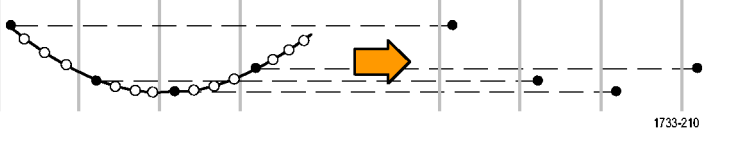
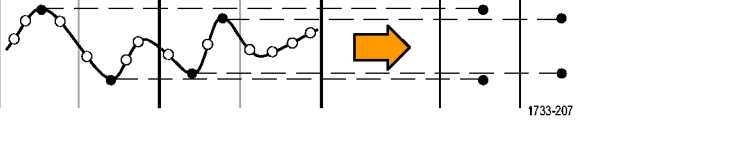
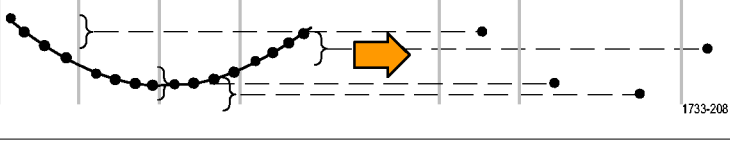
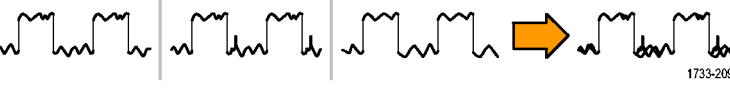
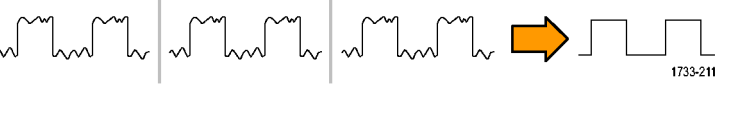
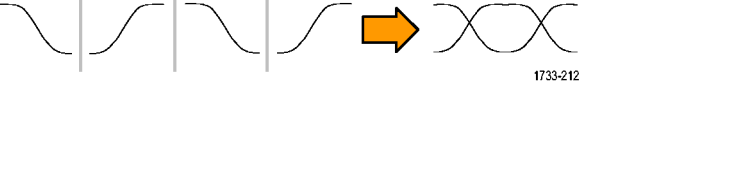
Acquisition mode	
<p>Sample mode retains the first sampled point from each acquisition interval. Sample is the default mode.</p>	 <p style="text-align: right;">1733-210</p>
<p>Peak Detect mode uses the highest and lowest of all the samples contained in two consecutive acquisition intervals. This mode only works with real-time, noninterpolated sampling and is useful for catching high frequency glitches.</p>	 <p style="text-align: right;">1733-207</p>
<p>Hi Res mode calculates the average of all the samples for each acquisition interval. Hi-Res provides a higher-resolution, lower-bandwidth waveform.</p>	 <p style="text-align: right;">1733-208</p>
<p>Envelope mode finds the highest and lowest record points over many acquisitions. Envelope uses Peak Detect for each individual acquisition.</p>	 <p style="text-align: right;">1733-209</p>
<p>Average mode calculates the average value for each record point over many acquisitions. Average uses Sample mode for each individual acquisition. Use average mode to reduce random noise.</p>	 <p style="text-align: right;">1733-211</p>
<p>Waveform Database mode is a three-dimensional accumulation of source waveform data over several acquisitions. In addition to amplitude and timing information, the database includes a count of the number of times a specific waveform point (time and amplitude) was acquired.</p>	 <p style="text-align: right;">1733-212</p>

Enable enhanced effective number of bits

Use this control, in the Acquisition tab, to turn the Enhanced Effective Number of Bits (ENOB) on or off to optimize waveform detail.

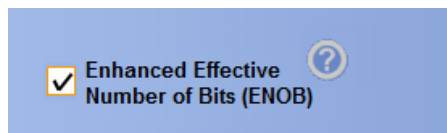

1. Click the **Enhanced Effective Number of Bits** check box to turn ENOB On or Off. You will find this control in the Acquisitions tab of the Horizontal/Acquisition control window.

Enhanced Effective Number of Bits enables interleaved correction DSP that improves the effective number of bits. This control is only available in some instrument models. This control is not available in Hi Res mode.

When Enhanced Effective Number of Bits is enabled, EB⁺ is displayed in the horizontal/acquisition readout.

Changing the acquisition mode

Use this procedure to change the acquisition mode.

1. Select **Horiz/Acq > Acquisition Mode**.
2. To select an acquisition mode, do one of the following:
 - Select an acquisition mode directly from the menu.
 - Click **Mode...**, and then select an acquisition mode.

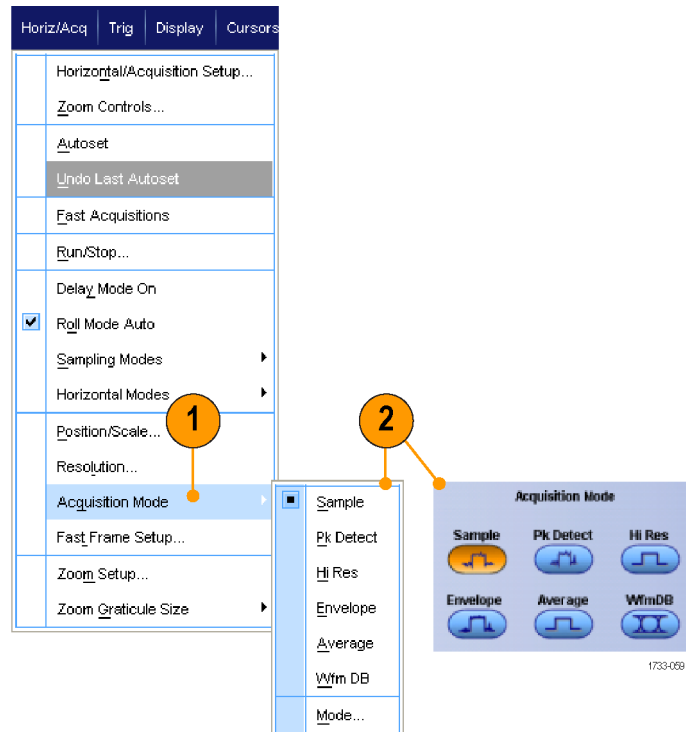

3. For Average or Envelope acquisition modes, click the **# of Wfms** control, and then set the number of waveforms with the multipurpose knob. For WfmDB mode, click the **Samples** control, and then set the number of samples with the multipurpose knob.

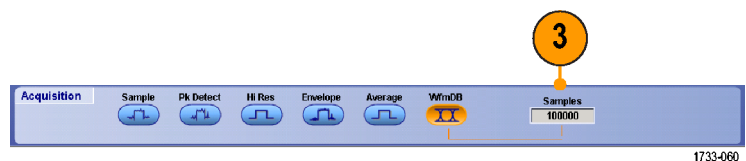

Quick tip

- Click the keypad icon to set the number of waveforms or samples.
- WfmDB mode is not available in multi-unit configurations.

Starting and stopping an acquisition

After the channels that you want to acquire are selected, use the following procedure.

1. To start the acquisition, select **Horiz/Acq** > **Run/Stop** and click **Run/Stop** or push the **RUN/STOP** button on the Auxiliary Front Panel.
2. To stop the acquisition, click **Run/Stop** again or push the **RUN/STOP** button.
3. To take a single acquisition, click **Single Sequence** or push the **Single** button.

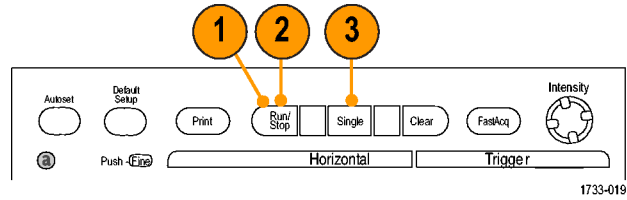

Selecting the horizontal mode

Your instrument has three horizontal modes. Automatic is the default mode. Select the horizontal mode that works best for your test setup.

To set the horizontal mode, select **Horiz/Acq** > **Horizontal/Acquisition Setup** to display the horizontal control window. Choose one of the modes described below.



In Automatic mode you can set the Scale and Sample Rate. Record length is a dependent variable. If changing the scale would cause the record length to exceed the Record Length Limit, the sample rate is decreased to the next available setting.

If the sampling mode is real time and the sample rate is at the real time limit, attempting to increase the sample rate has no effect.

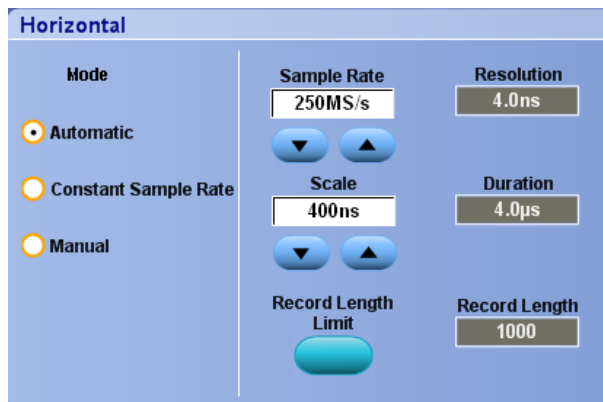

To set the Record Length Limit, click **Record Length Limit** and set the limit using the buttons or keypad. The default maximum limit depends on your instrument model and record length option.

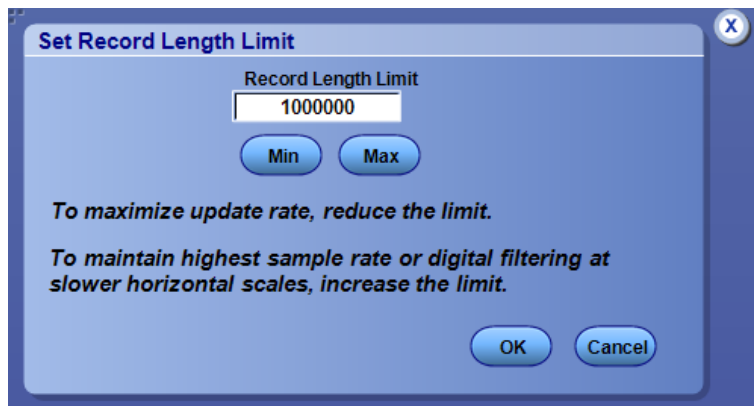

In Constant Sample Rate mode you can set the Sample Rate and Scale. The default sample rate ensures bandwidth filter operation. Record length is a dependent variable. The maximum record length depends on your instrument model and record length option.

The Auxiliary Front Panel resolution knob changes the sample rate in both automatic and constant sample rate modes.

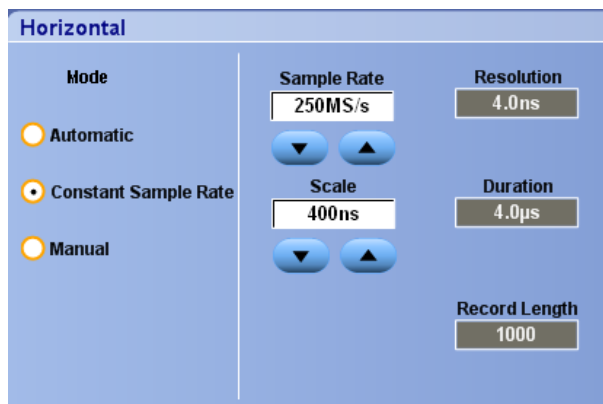

In Manual mode you can set the Sample Rate and Record Length. Horizontal Scale is a dependent variable calculated from the sample rate and record length.

The Horizontal Scale knob changes record length in manual mode.

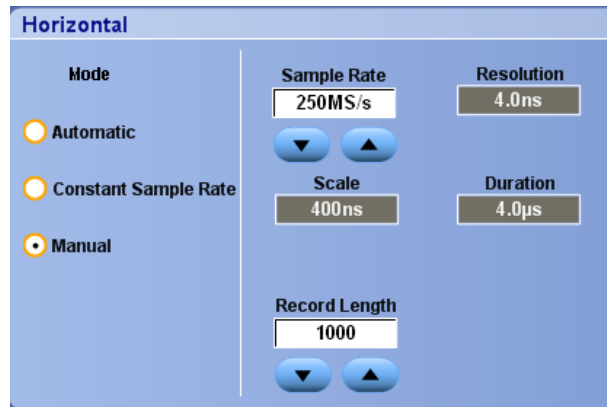

All three modes interact with sample rate, scale, and record length as shown. The horizontal line is the maximum real-time sample rate. Each staircase shows that as you increase the scale, the sample rate must decrease when either the maximum record length or the record length limit you set is reached. Manual mode uses the maximum record length.

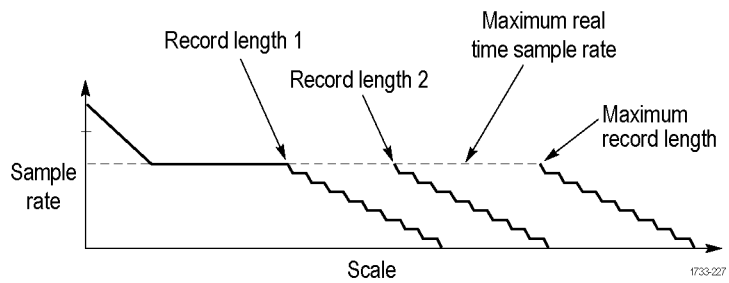

Automatic and Constant Sample Rate modes are identical. However, Constant Sample Rate mode keeps the sample rate constant at a rate that guarantees bandwidth enhancement filters are used.

Using FastAcq

Fast acquisition mode reduces the dead time between waveform acquisitions, enabling the capture and display of transient events such as glitches or runt pulses. Fast acquisition mode can also display waveform phenomena at an intensity that reflects their rate-of-occurrence. FastAcq is not available on AT1 channels and on some instrument configurations.

1. Push **FastAcq** on the optional front panel or select **Horiz/Acq > Fast Acquisition**.

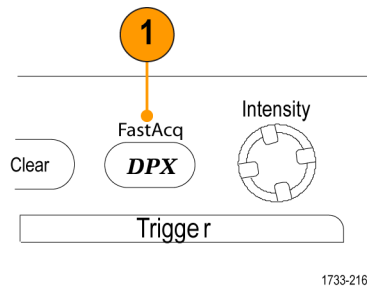

2. Find glitches, transients, or other random events.

When you have identified an anomaly, set the trigger system up to look for it. See [Capturing intermittent anomalies](#) on page 167.

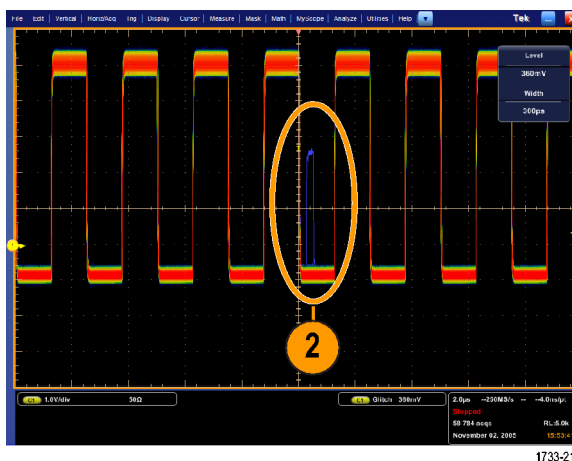

Quick tips

- To optimize for capturing details or rare events, select **Horiz/Acq > Horizontal/Acquisition Setup > Acquisition > Fast Acq**, and then select Optimize For **Capturing Details** or **Capturing rare events**.

Using DSP enhanced bandwidth

If your instrument has the enhanced bandwidth feature, use the DSP (digital signal processing) enhanced bandwidth for more accurate rise time measurements, to extend the bandwidth, and flatten the passband at the full sample rate. The enhanced bandwidth provides a matched response across enabled channels so you can perform channel-to-channel comparison and differential measurements.

1. Use **AUTOSET** to set the horizontal, vertical, and trigger controls or set the controls manually.

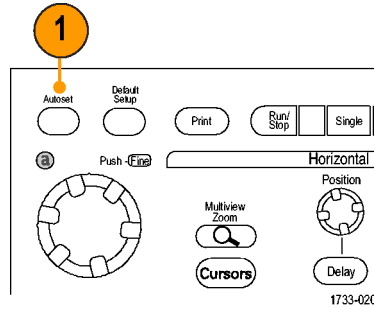

2. Select **Vertical > Bandwidth Enhanced...**

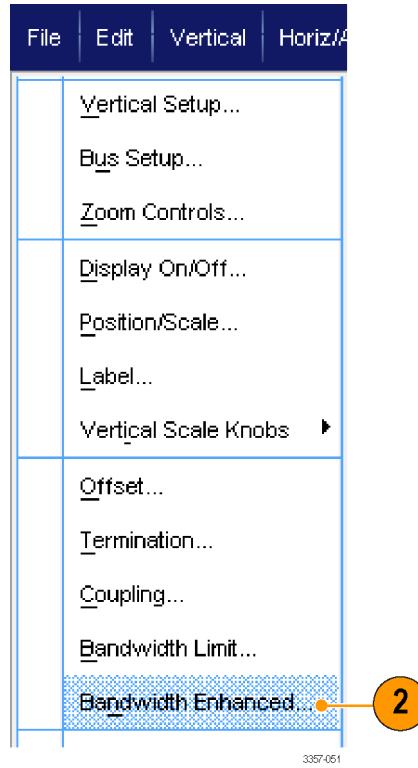

- Click **Digital Filters (DSP) Enabled** to turn the enhanced bandwidth on. You must set the sample rate correctly to enable DSP.
- To force a constant sample rate that enables DSP filters, check **Force Constant Sample Rate**.

NOTE. If not already set, selecting Constant Sample rate sets the horizontal mode to constant sample rate, sets the sample rate to allow DSP, and selects a DSP bandwidth.

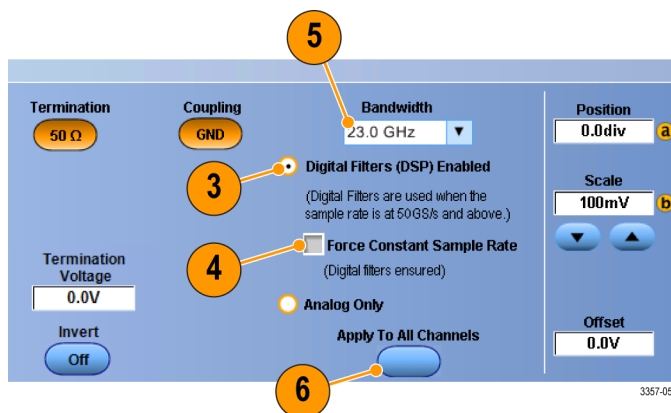

- Select the desired bandwidth from the **Bandwidth** list.

The available bandwidth selections depend on your instrument, probe, and probe tip.

Selecting Analog Only selects a hardware (HW) bandwidth.

- To apply your selections to all channels, check **Apply To All Channels**.

When different probing makes it impossible for the instrument to set all channels the same, the instrument sets each channel to the closest bandwidth value possible.

The bandwidth indicator appears in the vertical readout when the enhanced bandwidth is turned on.



Quick tips

- Right click the waveform handle to display a menu where you can select the channel bandwidth and other bandwidth enhanced settings.
- The DSP enhanced bandwidth occurs at maximum sample rate.
- Use the DSP enhanced bandwidth when your signals have rise times less than 50 ps.
- Select Analog Only for higher waveform throughput, overdriven signals, and when you prefer to use your own DSP post-processing.
- You can limit the instrument bandwidth by selecting Vertical > Bandwidth Limit and then selecting the bandwidth.

Setting the termination voltage

Oscilloscope inputs have traditionally been terminated to ground. The signals being measured often are not ground referenced. Pulling signals to ground can impair measurement results or potentially damage the DUT. Termination voltage is available on TekConnect channels, but not ATI channels.

The instrument delivers a variable termination voltage up to ± 3.5 volts to the device under test (DUT), and supports a large offset range. This allows you to adjust the oscilloscope to mirror the conditions and behavior of the DUT, and measure high-speed signals in an environment similar to the one in which they operate.

Using the combination of termination voltage and offset to center the oscilloscope reference point in the operating range of the DUT maximizes the available dynamic range and minimizes the noise of the measurement system.

To set the termination voltage of a channel, do these steps:

1. Select **Vertical > Vertical Setup**.

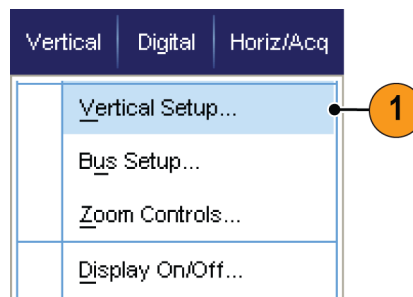

2. Click in the **Termination Voltage** field. Set the termination voltage using the keypad or multipurpose knobs.

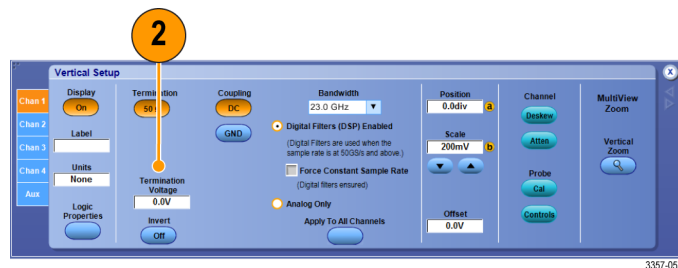

3357-053

Using roll mode

Roll mode gives a display similar to a strip chart recorder for low-frequency signals. Roll mode displays acquired data points without waiting for the acquisition of a complete waveform record.

1. Select **Horiz/Acq > Horizontal/Acquisition Setup....**

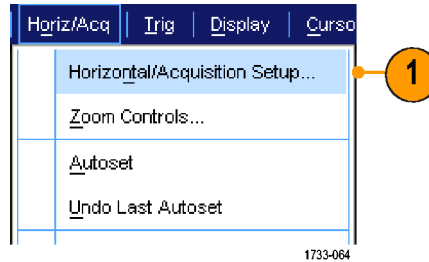

2. If not selected, click the **Acquisition** tab. Click **Auto** to turn on Roll mode.

NOTE. Roll mode requires *Sample, Peak Detect, or Hi Res acquisition mode.*

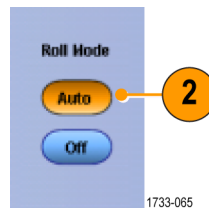

3. To stop acquisitions in Roll mode:

- If you are not in Single Sequence, select **Horiz/Acq > Run/Stop** and then click **Run/Stop** or push **RUN/STOP** on the Auxiliary Front Panel to stop Roll mode.
- If you are in Single Sequence, Roll mode acquisitions stop automatically when a complete record is acquired.

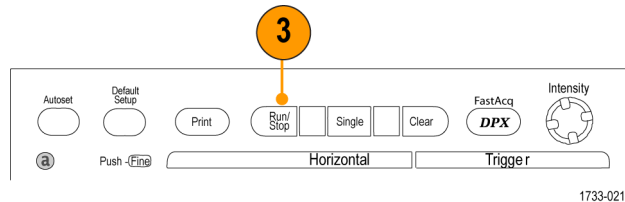

Quick tips

- Switching to Envelope, Average, or WfmDB acquisition mode will turn off Roll mode.
- Roll mode is disabled when you set the horizontal scale to 50 ms per division or faster.
- Roll mode is disabled when using a multi-unit configuration.

Setting up a bus

You can set up serial (optional) and parallel buses.

1. Select **Vertical > Bus Setup**.

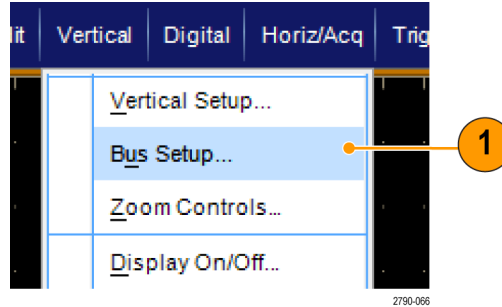

2. Select the **Config** tab.

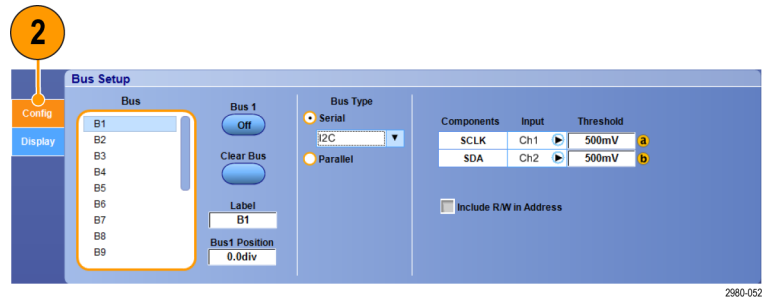

3. Scroll to, and then select the bus to set up.
4. To toggle the display of the bus on or off, click the **Bus** button.

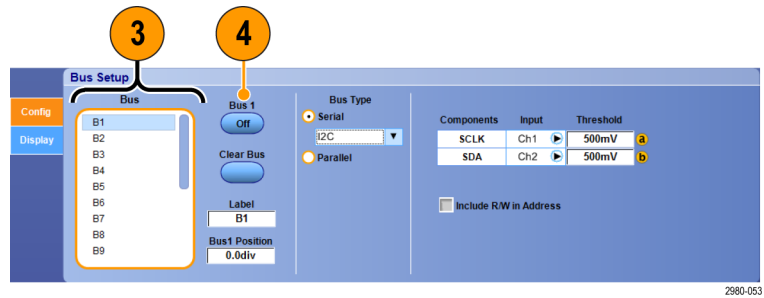

5. To change the default label of the bus, click **Label** and enter a new label using the keyboard.
6. To change the displayed position of the bus, click **Bus Position** and use the keyboard or multipurpose knob to enter a new bus position.

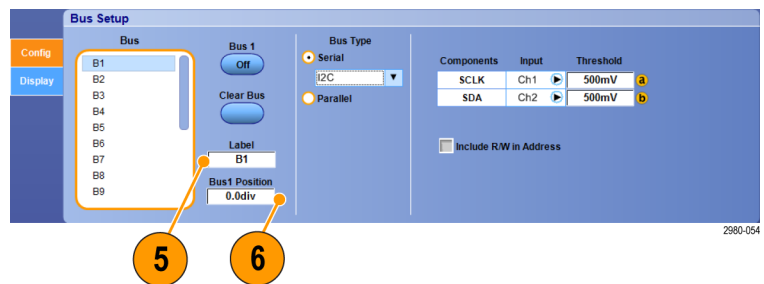

7. To select the bus type, click Bus Type **Serial** or **Parallel**.

You can set up each bus type.

See [Set up a serial bus](#) on page 64. or
See [Set up a parallel bus](#) on page 65.

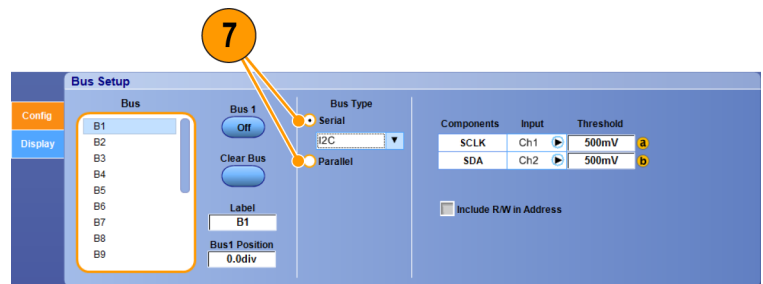

2980-055

Quick tips

- Position a bus or waveform by clicking on the bus or waveform handle and dragging the handle to the desired position.

Set up a serial bus

You can set serial (optional) bus parameters.

1. To set up a serial bus, select Bus Type **Serial** and select the type of serial bus from the drop-down list.

Each bus type has its own collection of parameters that you set up. Set up other bus types as appropriate for the selected bus.

See the online help for additional help setting up a bus.

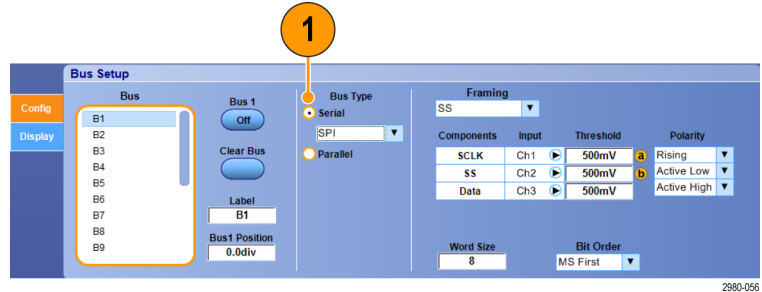

2. To select the input for the displayed components of the bus, click the component **Input** and select from the displayed list.

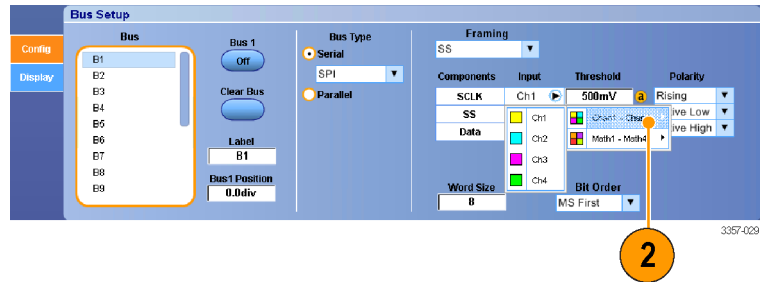

3. To set an input threshold, double click Threshold and enter the threshold using the keypad.

NOTE. To set thresholds independently when they are currently shared, go to **Trig > A Event (Main) Trigger Setup** and change **Settings to Independent**.

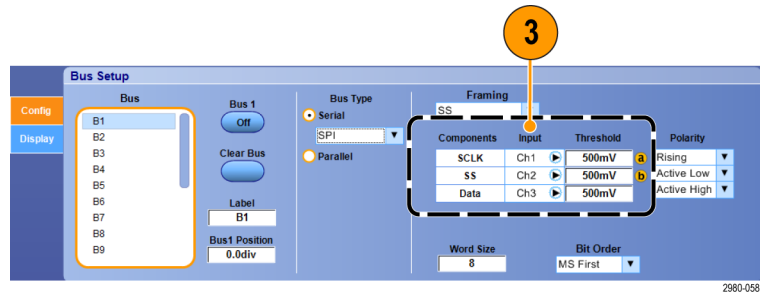

4. To select the polarity for the displayed components of the bus, click the component **Polarity** and select from the displayed list.

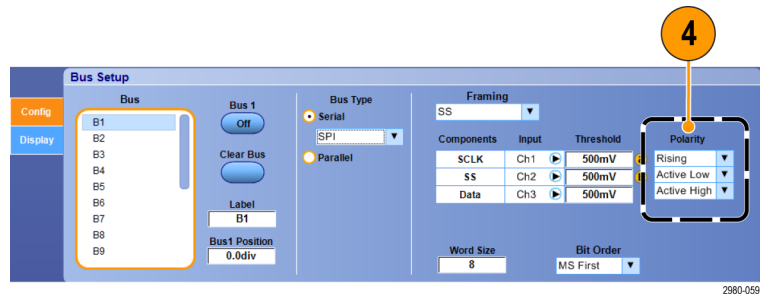

Quick tips

- To use a custom serial decoder, see the online help.

Set up a parallel bus

You can set parallel bus parameters.

1. To set up a parallel bus, select Bus Type **Parallel**.

See the online help for additional help setting up a bus.

2. To add sources to the bus, click the Add Sources **Select** button.

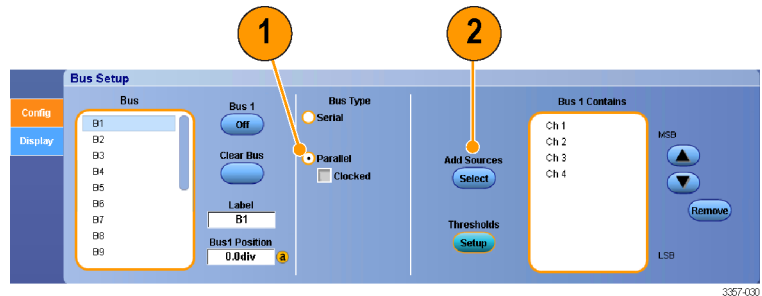

3357-030

3. Click the button for each channel you want in the bus. The order of the parallel bus is determined by the order in which you select the channels.

4. Click the **OK** button.

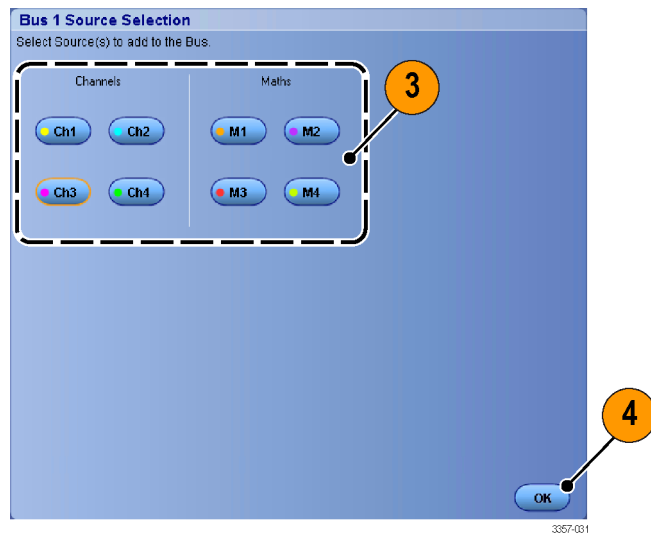

3357-031

5. To move a channel within the bus, scroll to and select the channel you want to move, and then click the up or down arrow buttons.

6. To remove a channel within the bus, scroll to and select the channel you want to remove, and then click the **Remove** button.

7. To set channel thresholds, click the Thresholds **Setup** button.

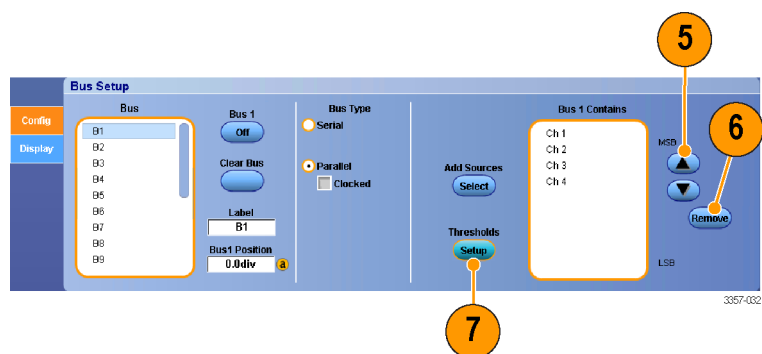

3357-032

8. For each threshold you want to set, double click the channel Threshold, and enter the threshold using the keypad or multipurpose knobs on the optional Auxiliary Front Panel.
9. When the desired thresholds have been set, click the **OK** button.
10. To set the clock source and polarity, double click the item and select from the displayed list. To set the clock level, double click the Clock Level, and enter the level using the keypad or multipurpose knobs on the optional Auxiliary Front Panel.

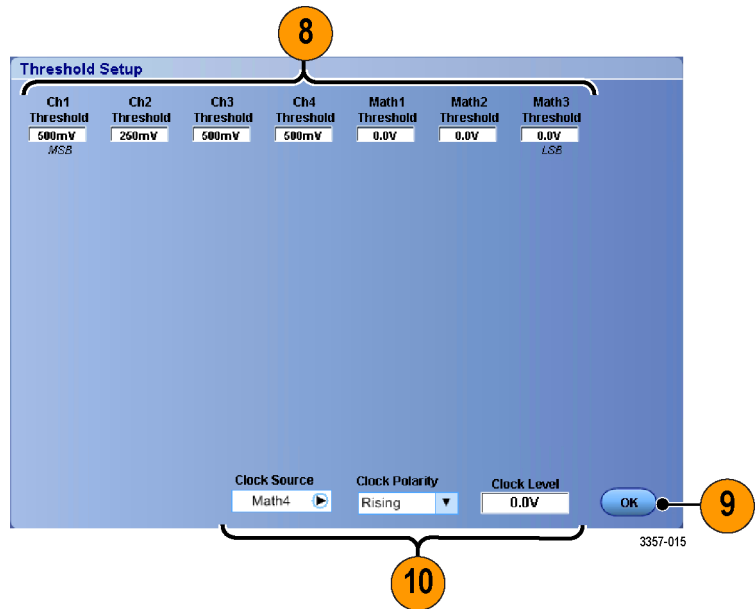

Set up bus display

You can set the bus style and decoding.

1. Select **Vertical > Bus Setup**.

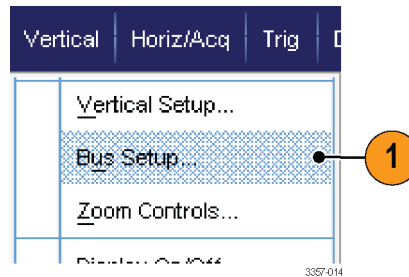

2. Select the **Display** tab.
3. To select the bus, scroll to display the bus, and then select the bus.
4. Select the decoding from the bus decoding list.

See the online help for information on the Results Table.

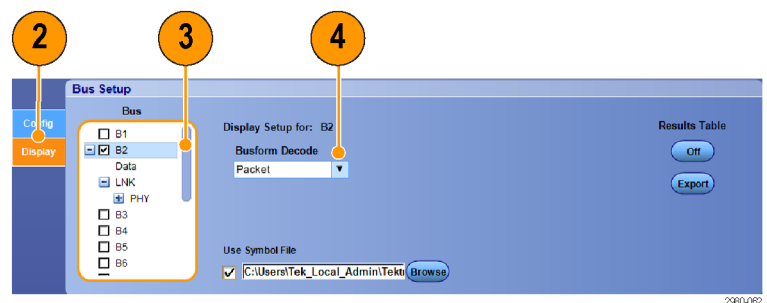

5. Click a + box to expand (display additional) the views, or click a - box to collapse (remove) views.

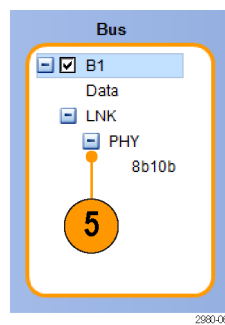

6. Bus views may also be added or removed from the display by clicking on the + box or - box in the display. Available views may include Transaction/transport, link/framing/packets, physical/bytes/symbols, and bit level.

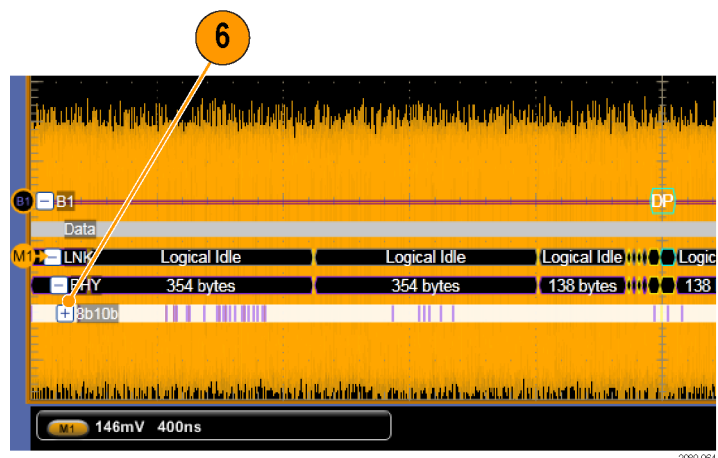

- If using a symbol table, check **Use Symbol File**. Click **Browse** and browse to the symbol table file.

For some buses other settings are available. Set the other settings as appropriate for your bus.

See the online help for additional help setting up a bus.

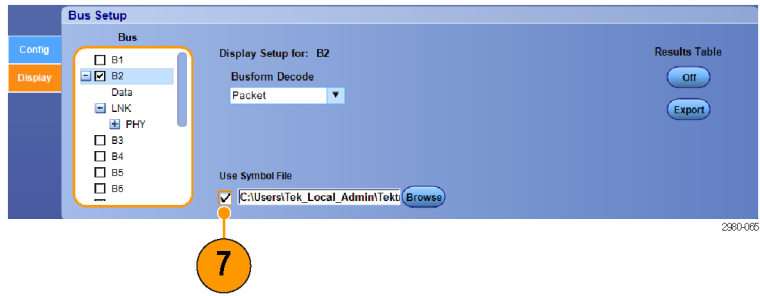

Using FastFrame mode

FastFrame allows you to capture many trigger events as single records in a larger record, and then view and measure each record individually. Time Stamps display the absolute trigger time for a specific frame and the relative time between triggers of two specified frames.

- Use **AUTOSET** to set the horizontal, vertical, and trigger controls or set the controls manually.

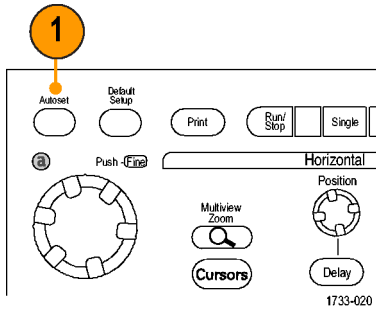

- Select **Horiz/Acq > FastFrame Setup....**

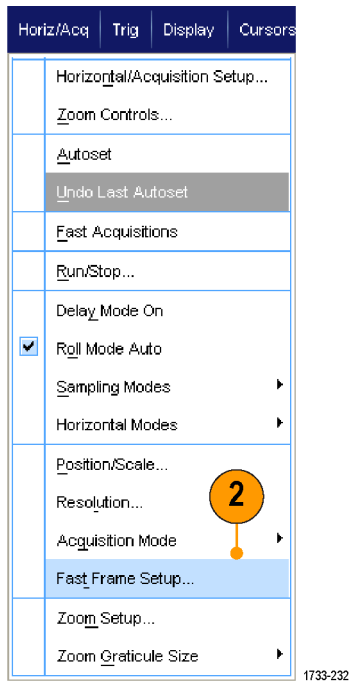

3. Push FastFrame to toggle it **On**.
4. Select **Frame Size** and **# of Events Frames**. Then use the multipurpose knobs to set each one. Number of frames represents the number of trigger events that are captured. Frame size is the number of samples that are stored with each trigger event (or frame). The number of frames is reduced if there is insufficient memory to store all the records. The shorter the frame length, the more frames you can acquire.

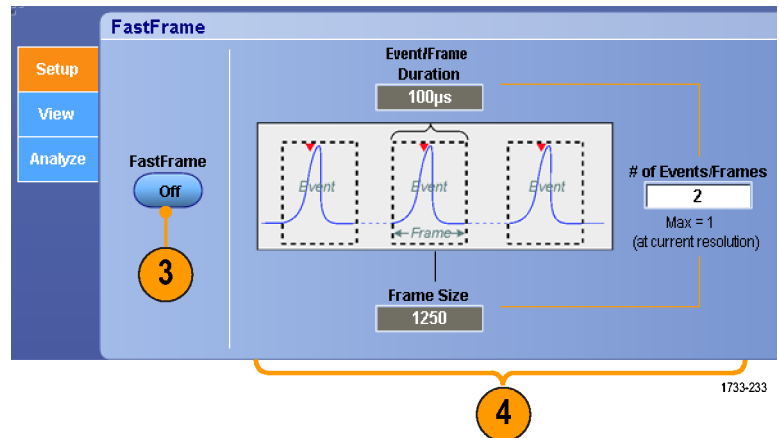

5. Use the Frame Viewing controls to select the frame that you want to view.
6. To view multiple frames superimposed over each other, select Overlay.

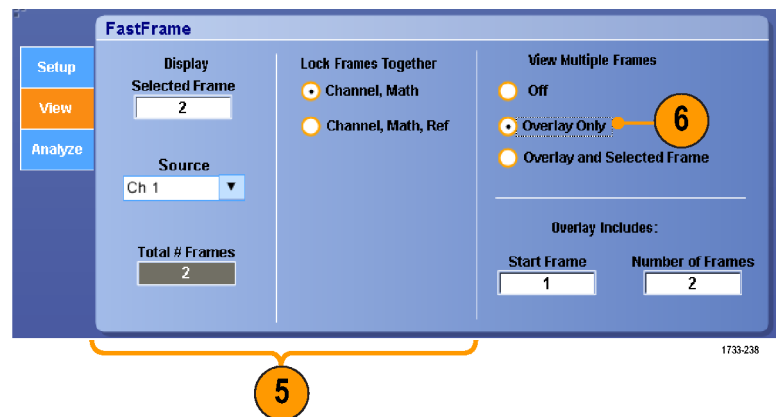

7. Use the Time Stamps controls to select the source for, and frame number of, the reference frame. The reference frame is the starting point when measuring the relative time between two frames.

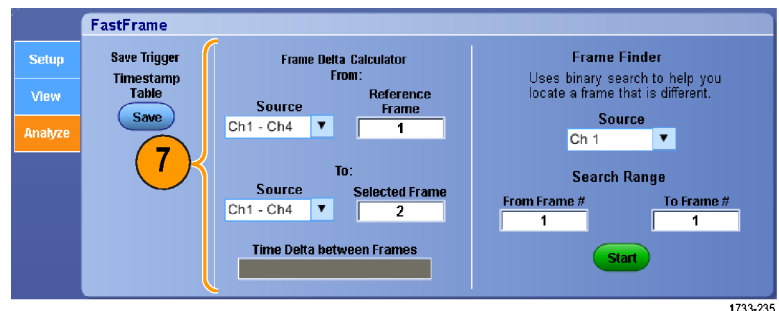

Quick tips

- Use FastFrame when you want to preserve the data associated with each trigger event for further analysis or visual inspections.
- Use FastFrame when you want to capture multiple events that have long dead times between them that are of no interest to you.
- Multiple frames are best viewed with the Normal, Green, or Gray color palettes because the dark blue selected frame may be hard to distinguish if you use Temp or Spectral.

- If you select an Average Summary Frame, you can set Math functions (Averaging) to apply to All Frames or have it apply to Only the Summary Frame. If the summary data is of primary interest, selecting Summary Frame Only can substantially improve system throughput.

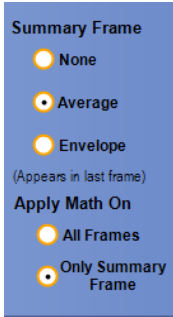

Using FastFrame frame finder

Frame finder allows you to find a FastFrame frame that is different from other frames.

1. Select the source of the FastFrame frames.
2. Set the Search Range by entering the From Frame # and the To Frame #.

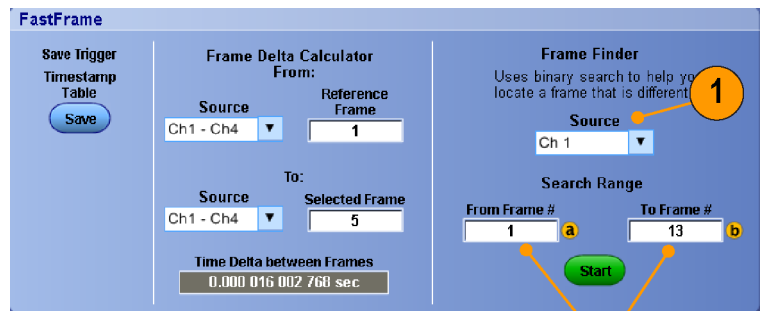

3. Stop acquisitions by selecting **Horiz/Acq** > **Run/Stop** and clicking **Run/Stop** or by pushing **Run/Stop** on the Auxiliary Front Panel.

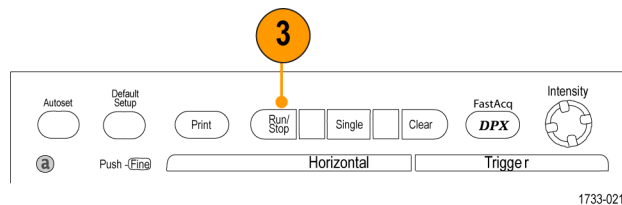

4. Push **Start** to start the search.

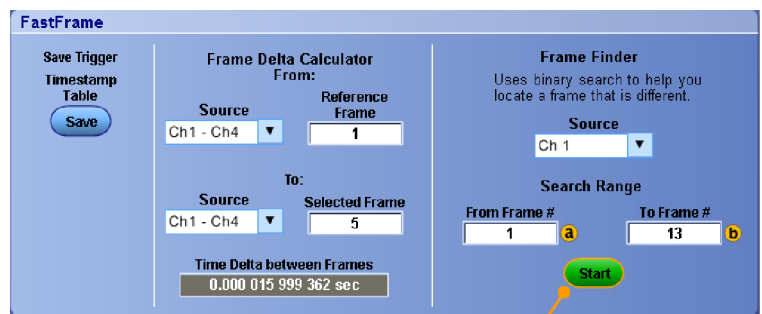

Frame Finder searches for and displays a different frame.

5. If the anomaly you are looking for is not in the displayed frame, push **No**. Frame Finder searches for another different frame.
6. If the anomaly you are looking for is in the displayed frame, push **Yes**.
7. If you are done searching, push **Stop**.

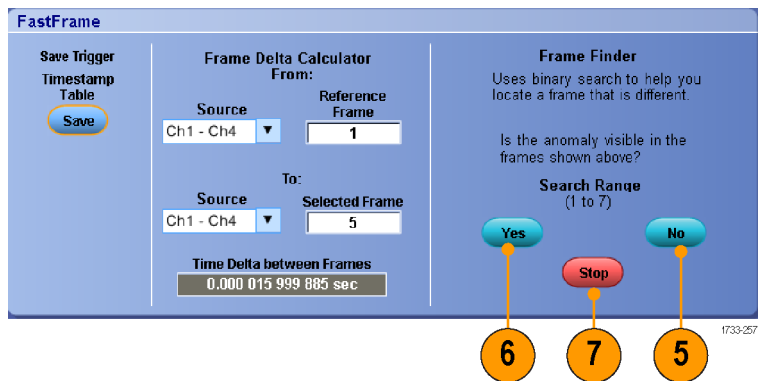

8. Select **Horiz/Acq > Run/Stop** and click **Run/Stop** or push **Run/Stop** on the Auxiliary Front Panel to restart acquisitions.

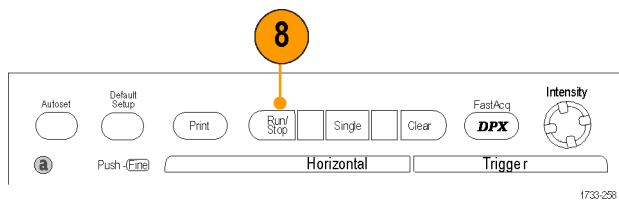

Pinpoint triggers

The Pinpoint trigger system comes with advanced trigger types that are usable on both A and B triggers, and it can reset the trigger sequence if the B event does not occur after a specific number of events or a specific time. Pinpoint triggers support capture of events based on the most complex trigger event or sequence of trigger events.

This section contains concepts and procedures for using the trigger system.

Triggering concepts

Trigger event

The trigger event establishes the time-zero point in the waveform record. All waveform record data are located in time with respect to that point. The instrument continuously acquires and retains enough sample points to fill the pretrigger part of the waveform record. When a trigger event occurs, the instrument starts acquiring samples to build the posttrigger part of the waveform record (displayed after, or to the right of, the trigger event). Once a trigger is recognized, the instrument will not accept another trigger until the acquisition is complete and the holdoff time has expired.

Trigger modes

The trigger mode determines how the instrument behaves in the absence of a trigger event:

- Normal trigger mode enables the instrument to acquire a waveform only when it is triggered. If no trigger occurs, the last waveform record acquired remains on the display. If no last waveform exists, no waveform is displayed.
- Auto trigger mode enables the instrument to acquire a waveform even if a trigger does not occur. Auto mode uses a timer that starts after a trigger event occurs. If another trigger event is not detected before the timer times out, the instrument forces a trigger. The length of time it waits for a trigger event depends on the time base setting.

Auto mode, when forcing triggers in the absence of valid triggering events, does not synchronize the waveform on the display. The waveform will appear to roll across the screen. If valid triggers occur, the display will become stable.

In edge-trigger mode, force the instrument to trigger by pushing the Force Trigger button on the Trigger Setup control window.

Select the trigger mode in the Trig > Mode menu. For more information, see the instrument online help.

Trigger holdoff

Trigger holdoff can help stabilize triggering, by extending the period in which further trigger recognition is suppressed after initiating an acquisition. Such an extension can help the system skip over the remaining events of a recurring burst of events, and thus always trigger on the first event in each burst. Adjust holdoff to obtain stable triggering when the instrument is triggering on undesired trigger events.

Set the trigger holdoff in the Trig > Holdoff menu. For more information, see the instrument online help.

Trigger coupling

Trigger coupling determines what part of the signal is passed to the trigger circuit. Edge triggering can use all available coupling types: AC, DC, Low Frequency Rejection, High Frequency Rejection, Noise Rejection, and RF coupling. All other trigger types use DC coupling only. Your instrument may not offer all coupling types.

Select the trigger coupling in the Trig > A Event (Main) Trigger Setup menu. For more information, see the instrument online help.

Horizontal position

Horizontal position defines where the trigger occurs on the waveform record. It lets you choose how much the instrument acquires before and after the trigger event. The part of the record that occurs before the trigger is the pretrigger part. The part that occurs after the trigger is the posttrigger part.

Pretrigger data is valuable when troubleshooting. For example, if you are trying to find the cause of an unwanted glitch in your test circuit, trigger on the glitch and make the pretrigger period large enough to capture data before the glitch. By analyzing what happens before the glitch, you may uncover information that helps you find the source of the glitch. Alternatively, to see what is happening in your system as a result of the trigger event, make the posttrigger period large enough to capture data after the trigger.

Slope and level

The slope control determines whether the instrument finds the trigger point on the rising or the falling edge of a signal. The level control determines where on that edge the trigger point occurs.

Delayed trigger system

You can trigger with the A (Main) trigger system alone or combine the A (Main) trigger with the B (Delayed) trigger to trigger on sequential events. When using sequential triggering, the A trigger event arms the trigger system, and the B trigger event triggers the instrument when the B trigger conditions are met. A and B triggers can (and typically do) have separate sources. The B trigger condition is based on a time delay or a specified number of events. See [Using A \(Main\) and B \(Delayed\) triggers](#) on page 79.

Choosing a trigger type

Your instrument allows you to modify basic trigger parameters from the Auxiliary Front Panel or set up more advanced triggers in the Trigger Setup control window.

NOTE. Some trigger type selections are not available on some instruments.

1. Select Trig > Edge Setup.

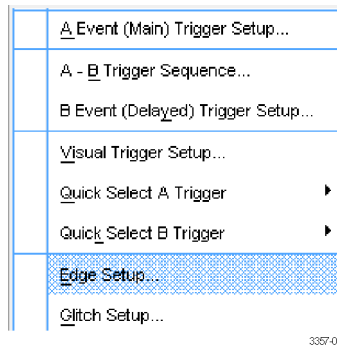

2. Set the source, slope, coupling, and mode using the setup menu.

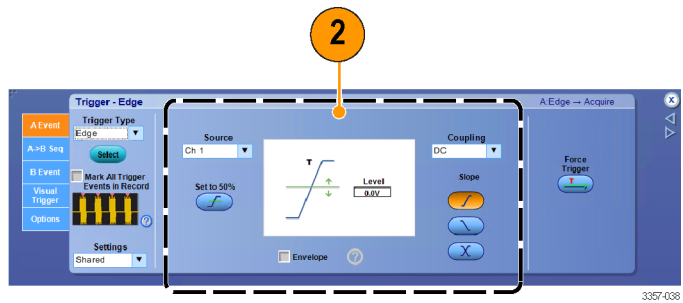



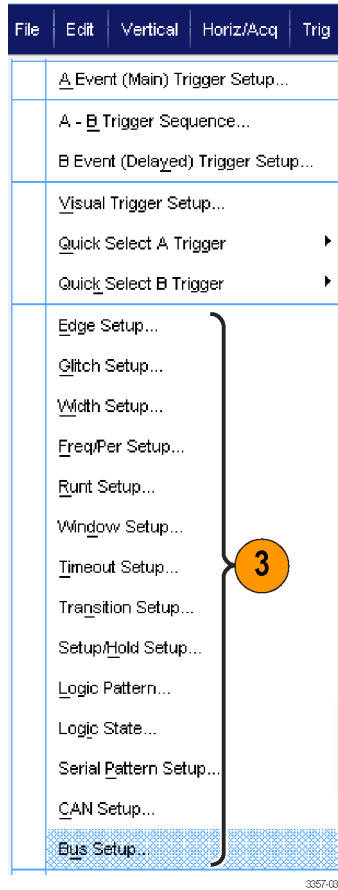



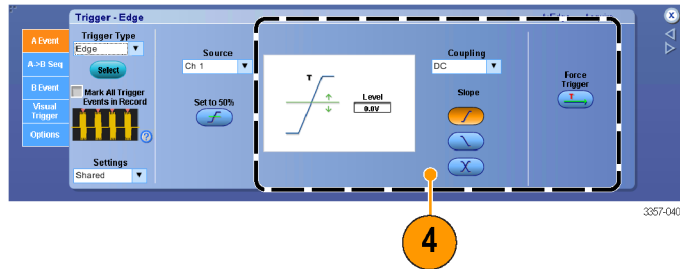





- To select one of the other trigger types, select a trigger type directly from the Trig menu.



- Complete the trigger setup using the controls displayed for the trigger type. The controls to set up the trigger vary depending on the trigger type, instrument model, and options.



Trigger selections

Trigger Type		Trigger Conditions
Edge		Trigger on a rising or falling edge, as defined by the slope control. Coupling choices are DC, AC, LF Reject, HF Reject, Noise Reject, and RF.
Glitch		Trigger on a pulse narrower (or wider) than the specified width or ignore glitches narrower (or wider) than the specified width.
Width		Trigger on pulses that are inside or outside a specified time range. Can trigger on positive or negative pulses.
Runt		Trigger on a pulse amplitude that crosses one threshold but fails to cross a second threshold before recrossing the first. Can detect positive or negative runs, or only those wider than a specified width. These pulses can also be qualified by the logical state of other channels. On multi-instrument configurations, this trigger is available on mapped channels.
Window		Trigger when the input signal rises above an upper threshold level or falls below a lower threshold level. Trigger the instrument as the signal is entering or leaving the threshold window. Qualify the trigger event in terms of time by using the Trigger When Wider option, or by the logical state of other channels using the Trigger When Logic option. On multi-instrument configurations, this trigger is available on mapped channels.
Timeout		Trigger when no pulse is detected within a specified time. On multi-instrument configurations, this trigger is available on mapped channels.
Transition		Trigger on pulse edges that traverse between two thresholds at faster or slower rates than the specified time. The pulse edges can be positive or negative. On multi-instrument configurations, this trigger is available on mapped channels.
Pattern		Trigger when logic inputs cause the selected function to become True or False. You can also specify that the logic conditions must be satisfied for a specific amount of time before triggering. On multi-instrument configurations, this trigger is not available.
State		Trigger when all of the logic inputs to the selected logic function cause the function to be True or False when the clock input changes state. On multi-instrument configurations, this trigger is not available.
Setup/ Hold		Trigger when a logic input changes state inside the setup and hold times relative to the clock. The mode triggers on a setup and hold violation. On multi-instrument configurations, this trigger is not available.
Serial		Trigger on up to 160 bit 8b/10b symbols at data rates up to 14.1Gb/s. Requires option ST14G. Includes clock recovery. Push the Push to Set 50% control to reinitialize clock recovery.
Bus		Trigger on components (such as a specified address) of a bus that you define. With some instruments, instrument configurations, and options, trigger types include parallel, 8b10b, SPI, RS-232, USB, and I ² C triggers.
Freq/Per		Trigger on a specified time or frequency range. On multi-instrument configurations, this trigger is available on mapped channels.

Checking trigger status

Check the trigger status from the readout or from the status lights on the Auxiliary Front Panel.

To quickly determine the settings of some key trigger parameters, check the Trigger readout at the bottom of the display. The readouts differ for edge and the advanced triggers:

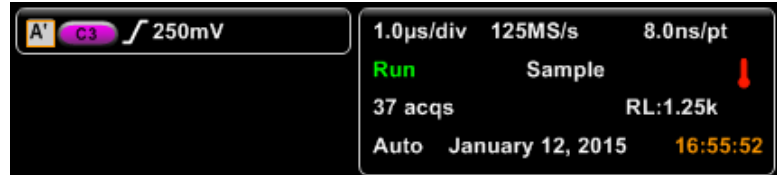

1. A trigger source = Ch3
2. Trigger slope = rising edge
3. Trigger level = 250 mV
4. Time base
5. Check the ARM, READY, and TRIG'D to determine the trigger status.
6. Check the trigger options menu to determine the trigger mode.

Check the ARM, READY, and TRIG'D Auxiliary Front Panel controls to determine the trigger status.

- If TRIG'D is on, the instrument has recognized a valid trigger and is filling the posttrigger part of the waveform.
- If READY is on, the instrument can accept, and is waiting for, a valid trigger to occur. Pretrigger data has been acquired.
- If ARM is on, the trigger circuitry is filling the pretrigger part of the waveform record.
- If both TRIG'D and READY are on, a valid A event trigger has been recognized and the instrument is waiting for a delayed trigger. When a delayed trigger is recognized, the posttrigger part of the delayed waveform will fill.
- If ARM, TRIG'D, and READY are off, acquisitions have stopped.

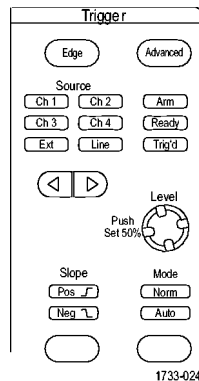

Using A (Main) and B (Delayed) triggers

You can use the A Event (Main) trigger for simple signals or combine it with the B Event (Delayed) trigger to capture more complex signals. After the A Event occurs, the trigger system looks for the B Event before triggering and displaying the waveform.

A trigger

1. Select Trig > A Event (Main) Trigger Setup....

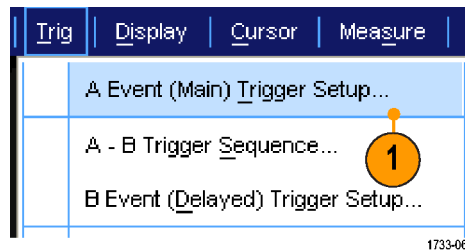

2. Set the A trigger type and source in the A Event tab.

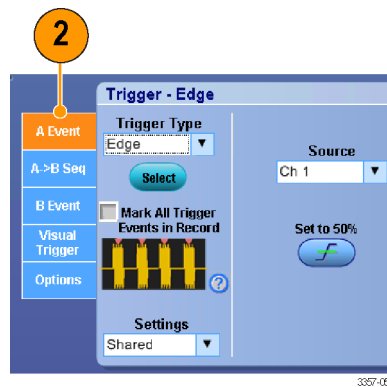

B trigger (Delayed)

NOTE. in a multi-unit system both the A and B trigger sources must be from the same unit.

3. Choose a function in the A → B Seq tab.
4. Set the trigger delay time or the number of B events.

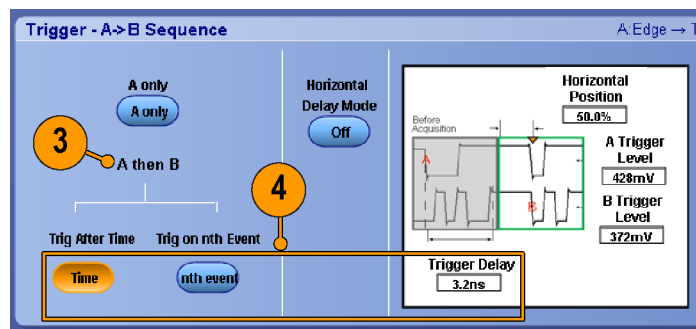

5. Set the B trigger characteristics in the B Event (Delayed) tab.

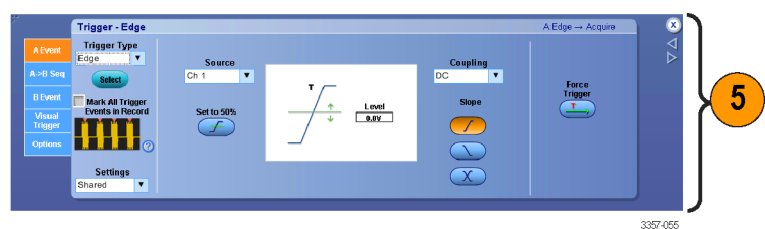

6. Select **Normal** Trigger Mode and **Auto** Holdoff in the Mode tab.

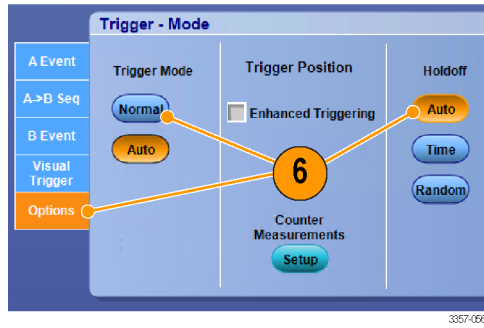

Trigger on B event

The A trigger arms the instrument. Posttrigger acquisition starts on the nth B event.

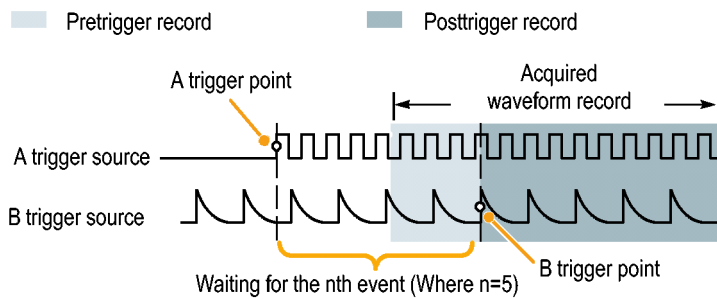

B trigger after delay time

The A trigger arms the instrument. Posttrigger acquisition starts on the first B edge after the trigger delay time.

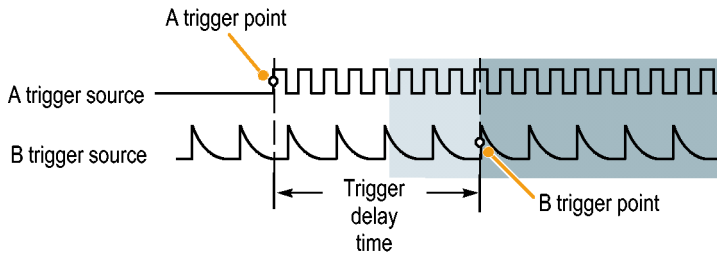

Triggering with reset

You can specify a condition to reset the trigger system if it occurs before the B trigger event. When the reset event occurs, the trigger system stops waiting for the B event and returns to waiting for the A event.

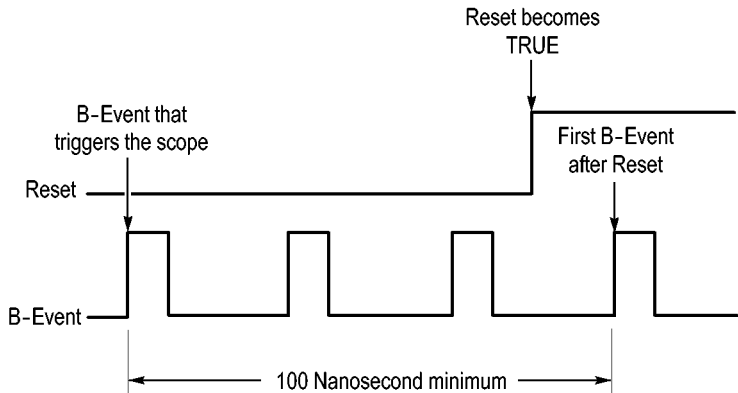

Quick tips

- B-trigger delay time and horizontal delay time are independent functions. When you establish a trigger condition using either the A trigger alone or the A and B triggers together, you can also use horizontal delay to delay the acquisition by an additional amount.

Correcting trigger position

Trigger position correction corrects for differences in the data path and the trigger path to more accurately place the trigger on the displayed waveform. Trigger position correction can also use averaging to more accurately place the trigger on noisy signals. To more accurately place edge triggers on the display, perform the following procedure.

1. To more accurately place the trigger on the display, check **Enhanced Triggering**. To more accurately place the trigger on noisy signals, also check **Optimized for Noisy Signals**.

The **Optimized for Noisy Signals** selection is only available if **Enhanced Triggering** is selected.

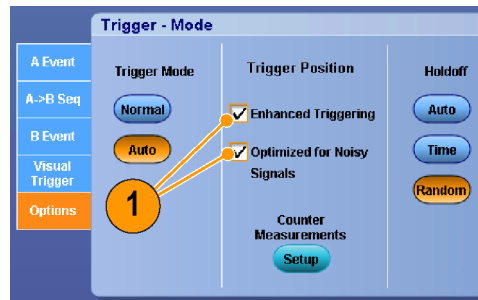

3357-057

Triggering with B-Event scan

Use A->B Sequence B-Event Scan to create overlapped eye diagrams synchronized or initiated by an A trigger event.

Trig on nth Event captures the nth B-Event that occurs after the A-Event for all acquisitions. B-Event Scan automatically advances the B-Event value to capture different portions of the signal.

1. Set the A trigger type and source in the A Event tab.

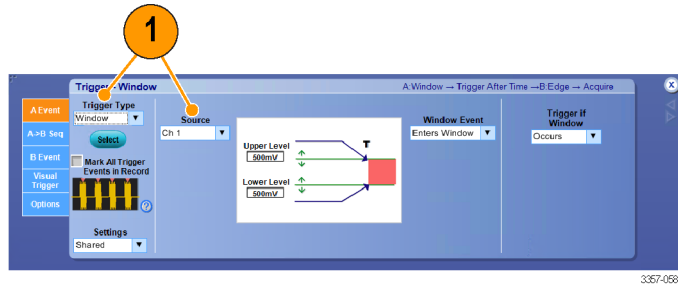

2. Set the B trigger type and source in the B Event tab.

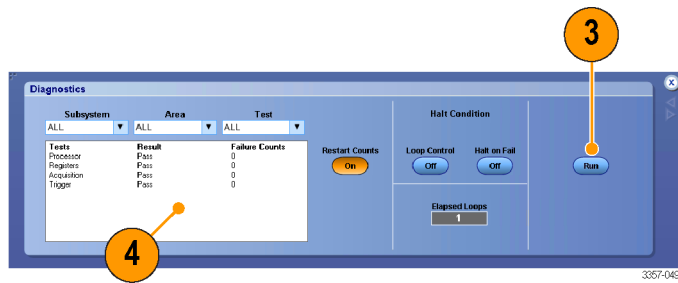

3. To more accurately place the trigger on the display, check **Enhanced Triggering**. To more accurately place the trigger on noisy signals, also check **Optimized for Noisy Signals**.

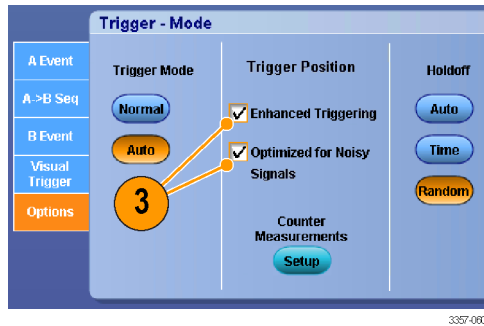

4. Select Trig on nth Event and B Event Scan in the A->B Seq tab.
5. To display the B Event Scan Setup window, press B Event Scan > Setup.

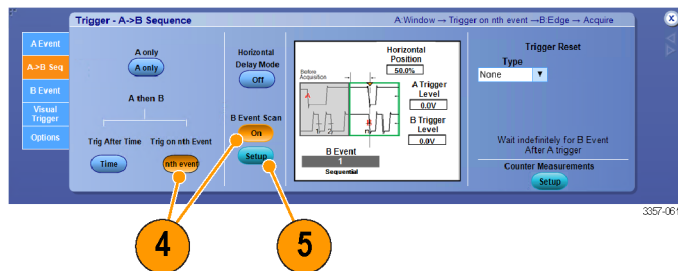

6. Set the B Event start value.
7. Set the B Event ending value.
8. Set the number of acquisitions before the B Event value is incremented.

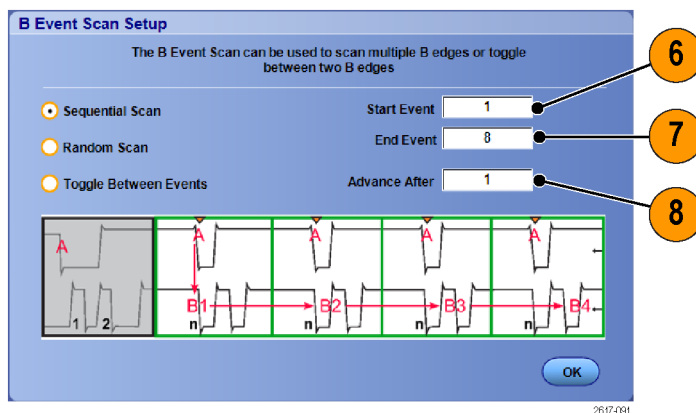

9. Select the method that the B Event value is incremented after the selected number of acquisitions occur:

Sequential Scan increments by 1 until the End Event is reached. When the End Event is reached, the B Event value is reset to the Start Event value and the process starts over.

Random Scan sets the B Event value to a random value between the Start Event and the End Event for each set of Advance After acquisitions.

Toggle Between Events toggles the B Event value between the Start Event and the End Event for each set of Advance After acquisitions.

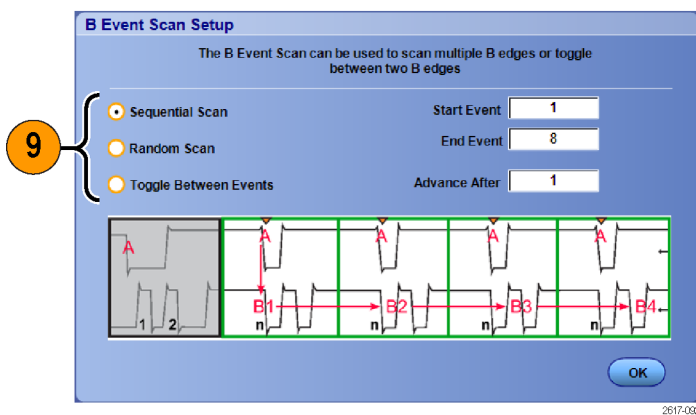

10. In this example, a DDR3 DQS signal is on Ch 1 and the DQ signal is on Ch 2. The instrument is in Run Mode with Display Mode set to Infinite Persistence. The instrument trigger setup was as follows:

A-Event Window trigger on Ch 1 to detect the DDR3 DQS Write condition.

B-Event Edge trigger on Either slope on Ch 1 to trigger on the DQS (clock) edges.

A->B Sequence set to Trig on the nth Event.

B Scan Enabled with Start Event = 1, End Event = 8, and Mode = Sequential.

The data eyes are formed by the DQ signal on Ch 2.

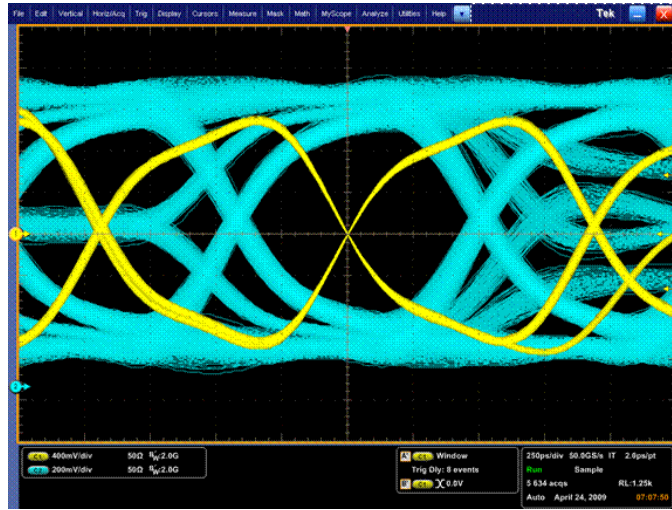

Triggering on a parallel bus

Locate problems by triggering on a parallel bus.

1. Set up a parallel bus. See [Setting up a bus](#) on page 62. Select **Trig > A Event (Main) Trigger Setup...**

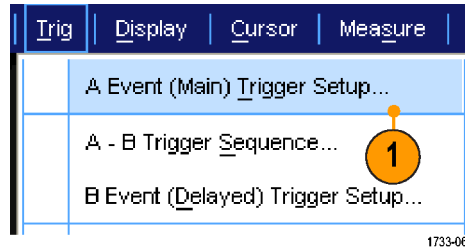

2. Select the A Event tab.

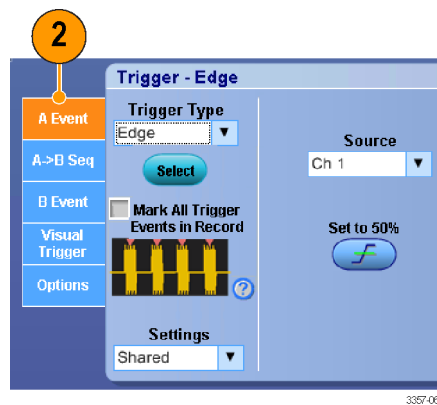

3. Select the Bus Trigger Type.

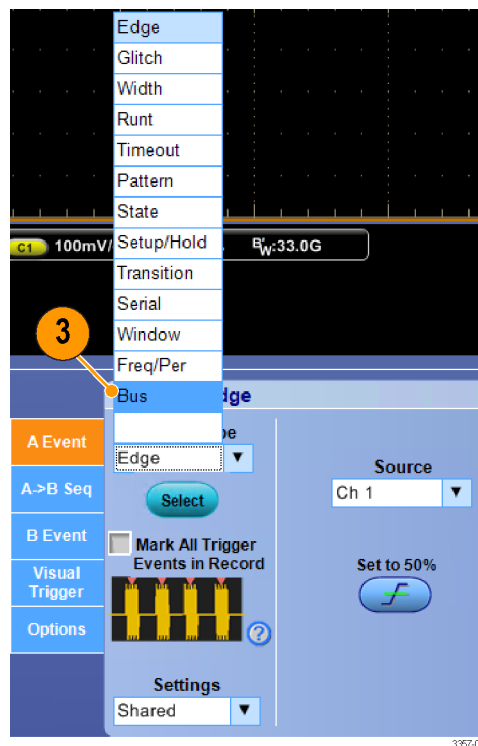

- Select the bus to trigger on.

NOTE. Clocked buses will only appear in the drop down list if the clock source is set to Ch4.

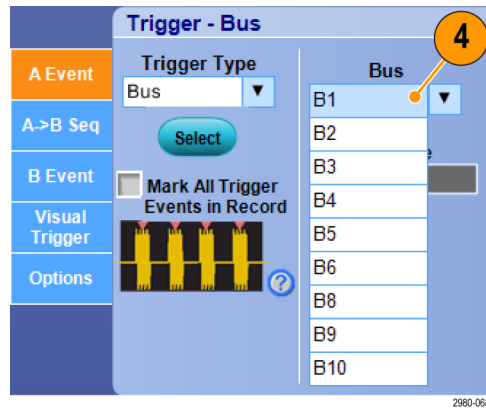

- Click an Edit button and set the pattern and format that you want to trigger on.

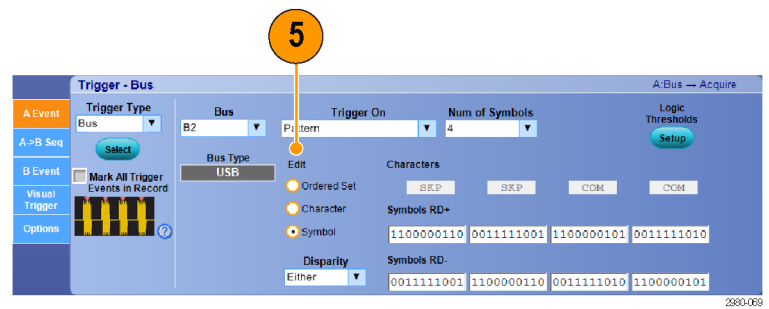

- Select the data format.
- Set the pattern to trigger on using the keypad.

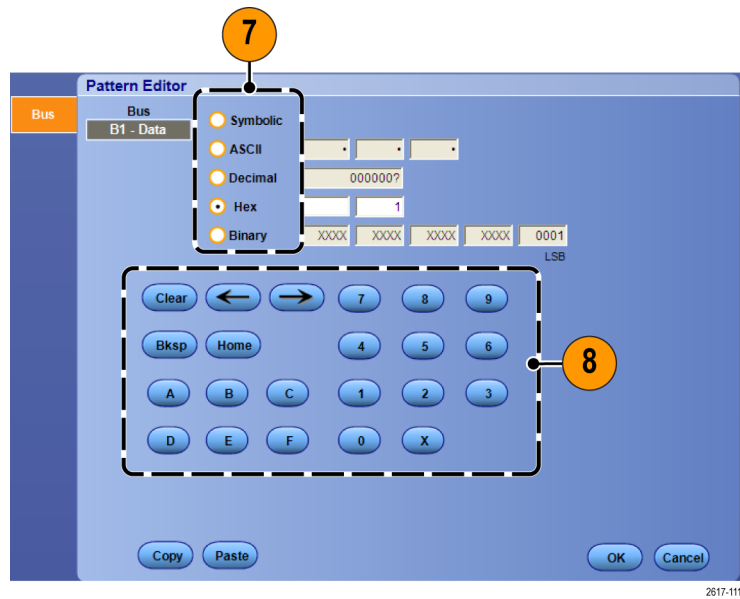

- Analyze your waveforms.

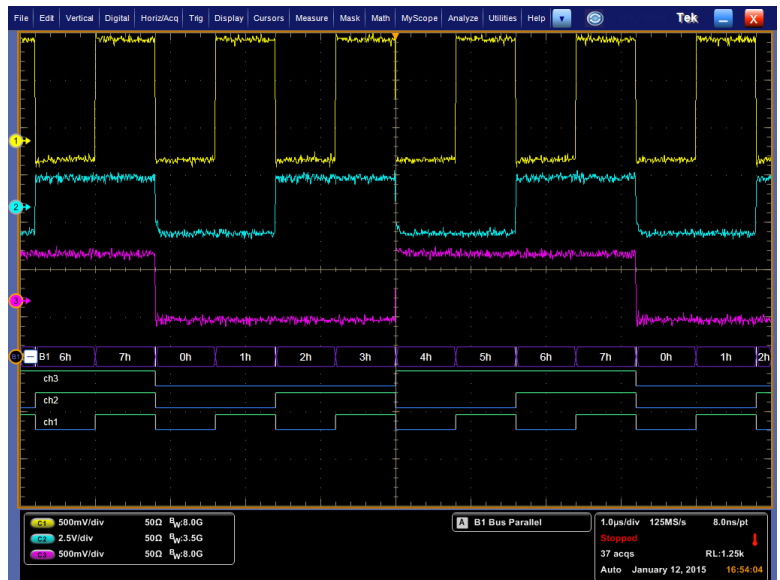

Triggering on a serial bus

Locate problems by triggering on a serial bus.

Set up a serial bus. See [Setting up a bus](#) on page 62.

- Select Trig > A Event (Main) Trigger Setup....

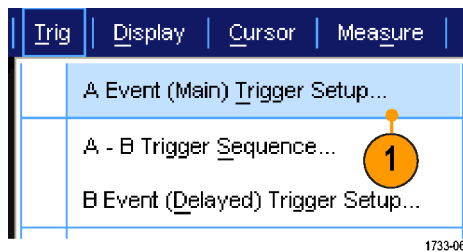

- Select the A Event tab.

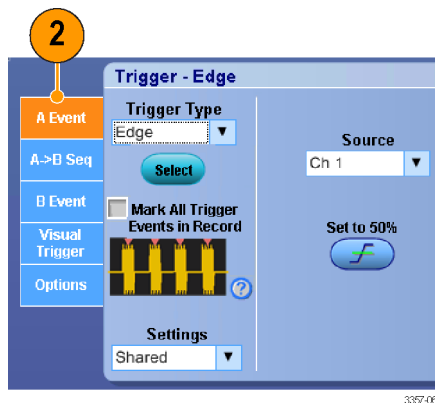

3. Select the Bus Trigger Type.

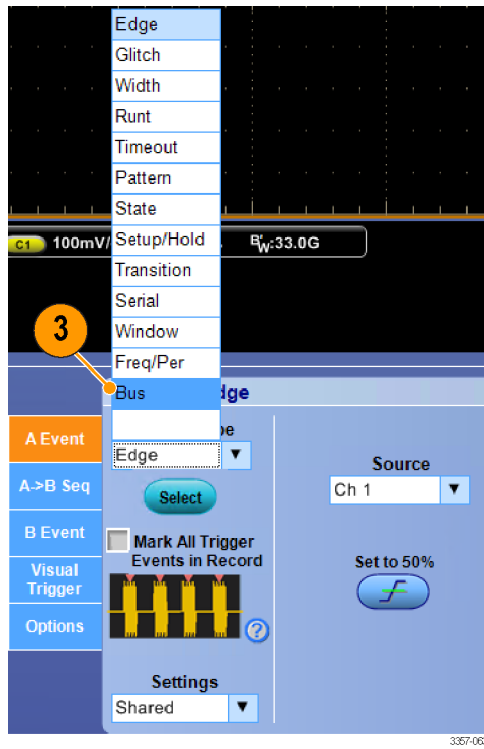

4. Select the bus.

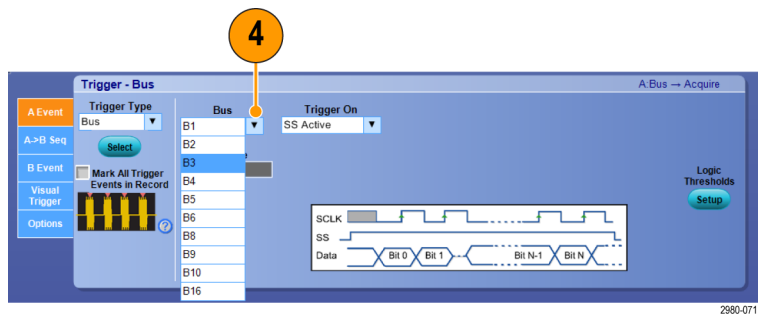

5. Select the bus signal to trigger on.
6. Depending on your Trigger On choice and your bus type, make the required selections for the bus.

See the online help for additional help setting up a bus.

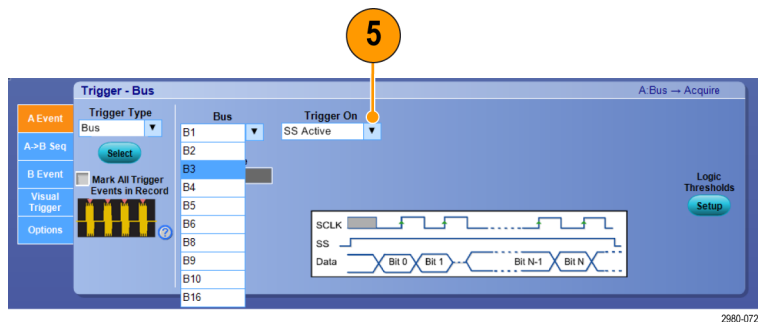

Triggering using visual triggers (Visual triggering)

Visual triggering allows you to create trigger conditions directly on the display screen. (Visual Triggers are available as an option on some models.)

1. Create a visual trigger area by left clicking and dragging a box on the display. Then select Add Visual Trig Area from the menu.

NOTE. This same menu allows you to hide or show all visual trigger areas and toggle visual triggering on and off.

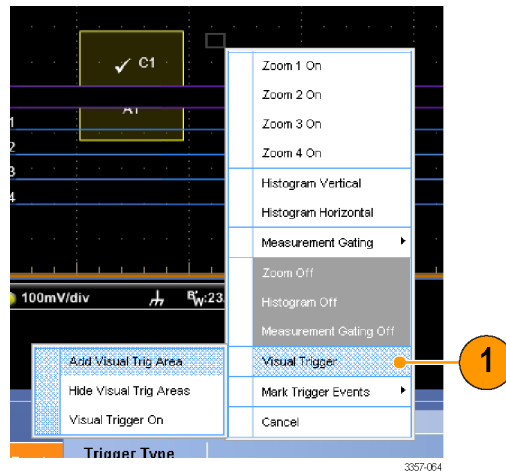

2. Click the area to enable its handles. Click and drag the area to move it to a new location. Click and drag one of the area handles to resize the area vertically, horizontally, or both.

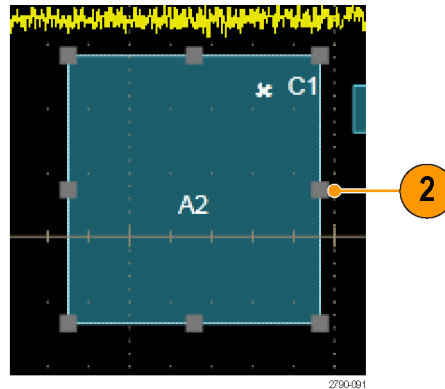

3. Right click in the visual trigger area and select Visual Trigger Area from the menu.

Use the visual trigger menus to edit the trigger area and set conditions for the visual trigger.

Refer to online help for detailed information about creating and editing visual triggers.

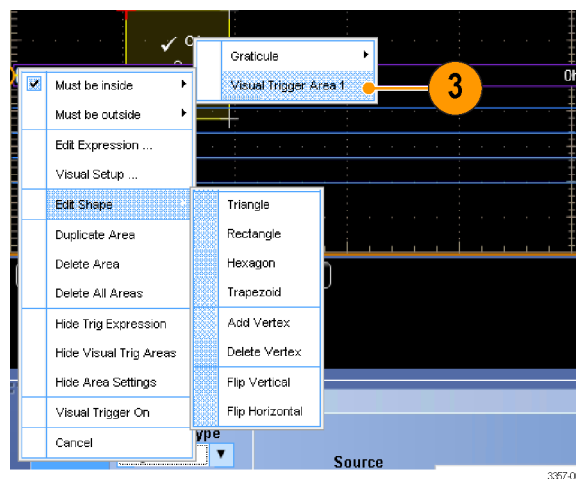

- From the Trig menu, select Visual Trigger Setup, then double click the Visual Trigger equation.

Refer to online help for detailed information about using the Qualification Expression Editor.

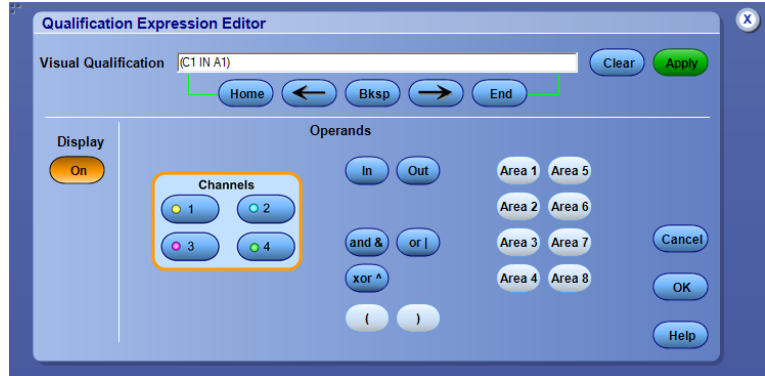

Setting up action on event

Action on Event allows configure the oscilloscope to save a variety of files when a defined event takes place, such as a trigger events, mask test failures, and limit test failures.

1. Select **File > Action on Event**.
2. Select the event to use.
3. Select the action to take when the event occurs. Select Save, Send E-mail, or both.

Use the Setup button (next to Save) to display the Save on Event Setup display screen.

Use the Setup button (next to Send E-mail) to display the Send E-mail Setup display screen. See [Setting up E-Mail on event](#) on page 93.

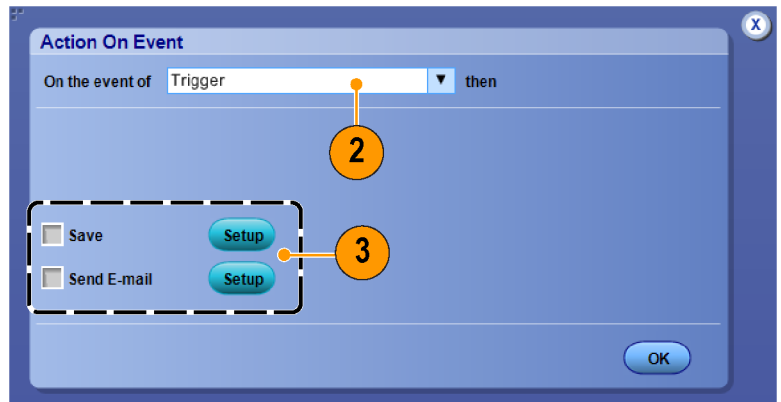
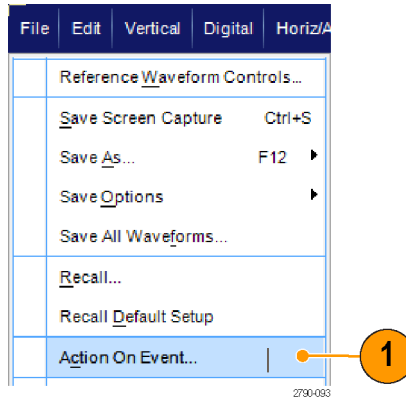

4. Enter the location to save the files.
5. Select the event that initiates a save.
6. Select what type of files to save on the event.
7. Set the file naming convention to use.
8. Set the number of events to save.

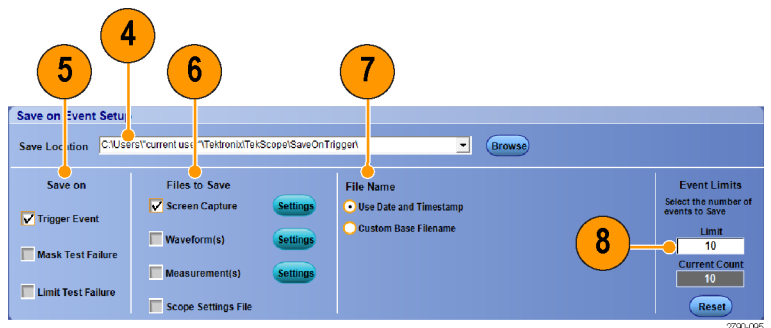

Sending E-Mail on trigger

You must configure e-mail on event before performing the following procedure. See [Setting up E-Mail on event](#) on page 93.

1. Select **Trig > A Event (Main) Trigger Setup...**
2. Select the **Mode** tab.
3. Under E-mail on Trigger, click **On**, and then click **Setup**. See [Setting up E-Mail on event](#) on page 93.

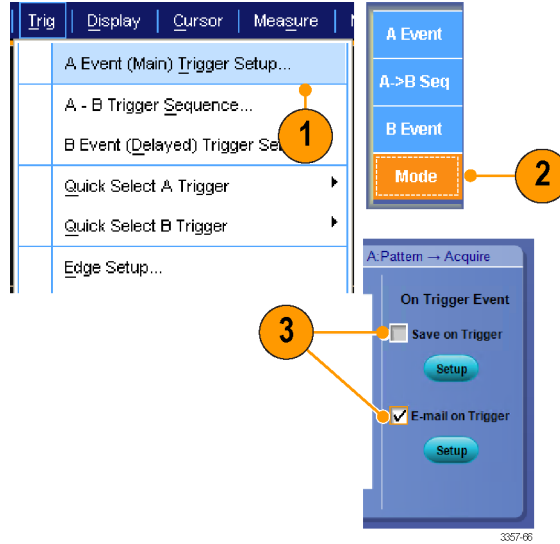

Setting up E-Mail on event

1. Select **Utilities > E-mail on Event > Setup...**

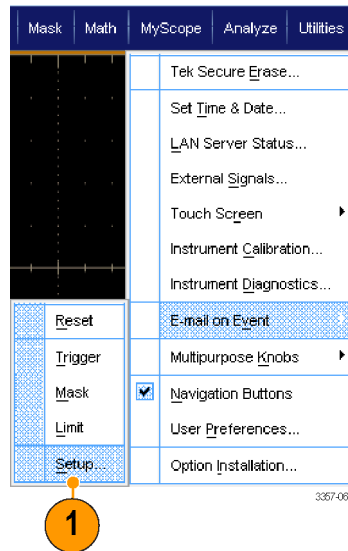

2. Enter recipients' e-mail address(es). Separate multiple entries with commas. There is a limit of 252 characters in the e-mail address box.

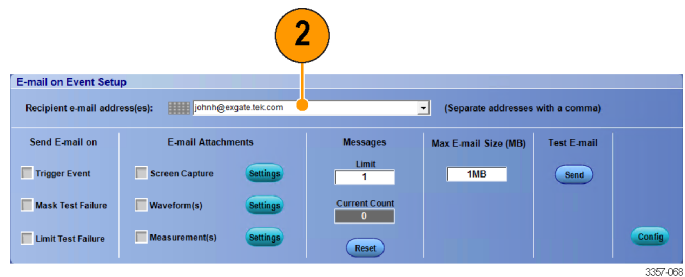

3. Click **Config**, and then enter the SMTP Server Address. Contact your network administrator for the correct address.

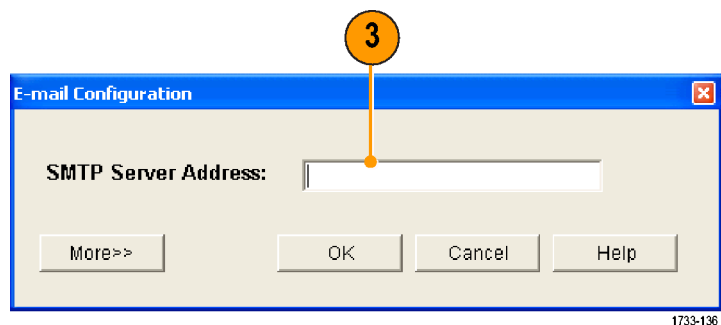

4. Select the event(s) for which you want to send an e-mail.
5. To include attachments, select the type of attachment, and then click **Settings** to specify the format.

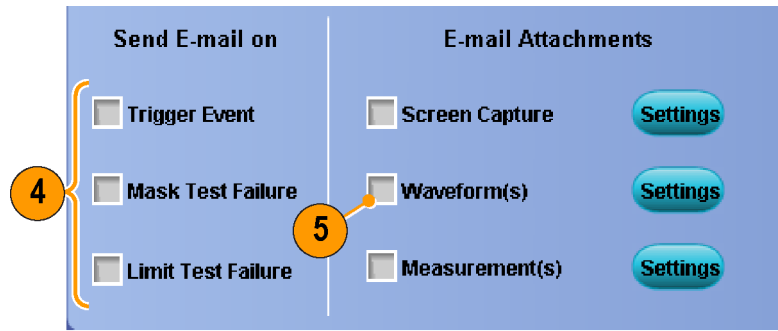

1733-137

6. Set the maximum message limit and e-mail size. When the maximum message limit is reached, you must click **Reset** to send more e-mails on event.
7. To verify that you have set up the e-mail addresses correctly, send a test-mail by clicking **Send**.
8. If necessary, click **Config** to access the e-mail configuration dialog box and adjust the configuration.

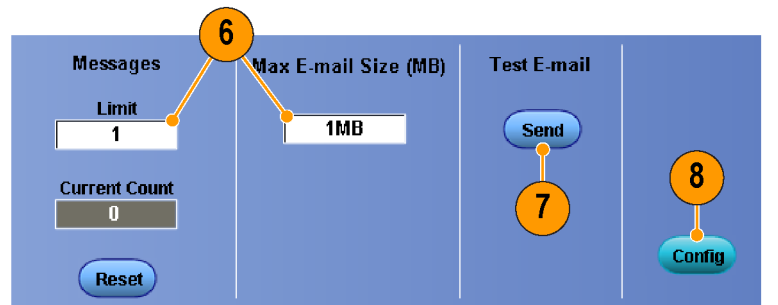

1733-138

Using horizontal delay

Use horizontal delay to acquire waveform detail in a region that is separated from the trigger location by a significant interval of time.

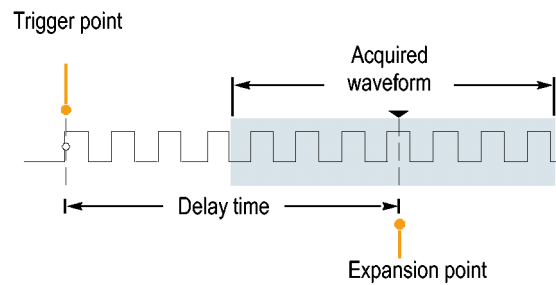

1. Select **Horiz/Acq > Horizontal/Acquisition Setup**.

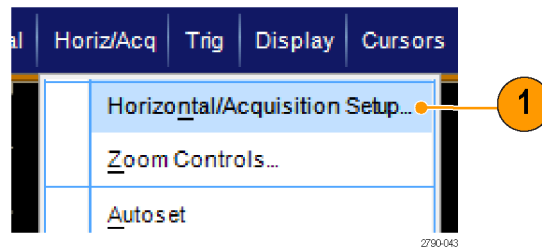

2. Push the **Delay Mode** button to toggle delay mode on.
3. Adjust the delay time with the horizontal **POSITION** control, or enter the delay time in the control window.
4. Adjust the horizontal **SCALE** to acquire the detail that you need.

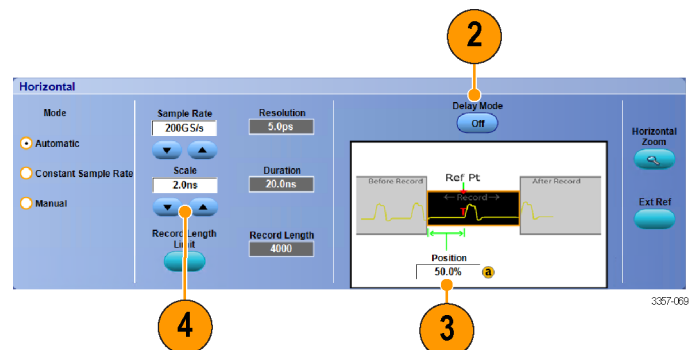

Quick tips

- Use MultiView Zoom and Horizontal Delay together to magnify a delayed acquisition.
- Toggle Horizontal Delay on and off to quickly compare signal details at two different areas of interest, one near the trigger location and the other centered at the delay time.

Display a waveform

This section contains concepts and procedures for displaying a waveform. Detailed information is available in the online help.

Setting the display style

To set the display style select **Display > Display Style**, and then select one of the following styles:

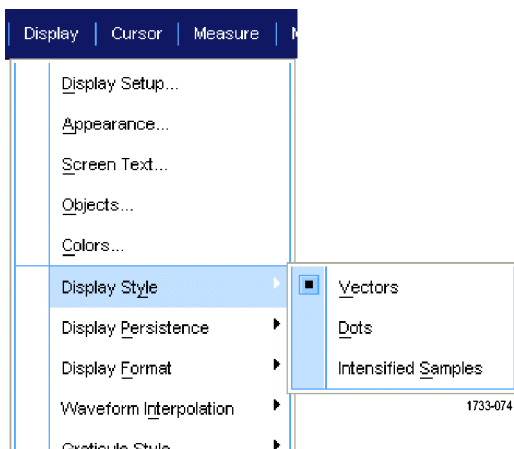

Vectors. Displays waveforms with lines drawn between record points.

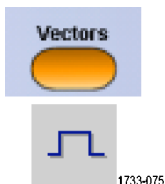

Dots. Displays waveform record points as dots on the screen.



Intensified Samples. Displays the actual samples. Interpolated points are not displayed.



Setting the display persistence

Select **Display >Display Persistence**, and then select the type of persistence.

- No persistence shows record points for the current acquisition only. Each new waveform record replaces the previously acquired record for a channel.
- Infinite persistence continuously accumulates record points until you change one of the acquisition display settings. Use for displaying points that may occur outside the normal acquisition envelope.
- Variable persistence accumulates record points for a specified time interval. Each record point decays independently according to the time interval.
- Reset persistence clears the persistence.

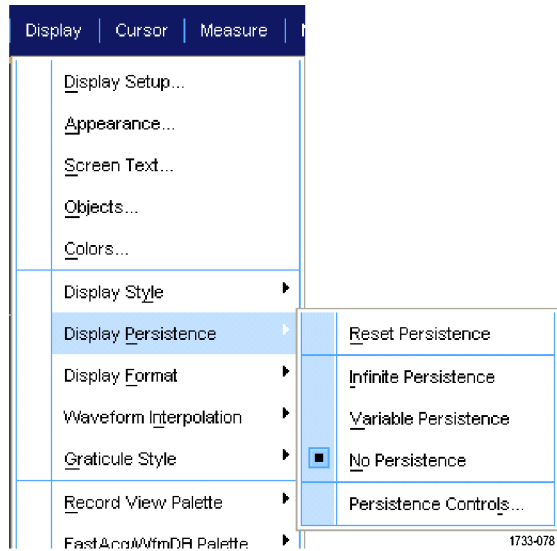

1. To set the variable persistence time, select **Display >Display Persistence >Persistence Controls...**
2. Click **Variable, Persist Time**, and then use the multipurpose knobs to set the persistence time.

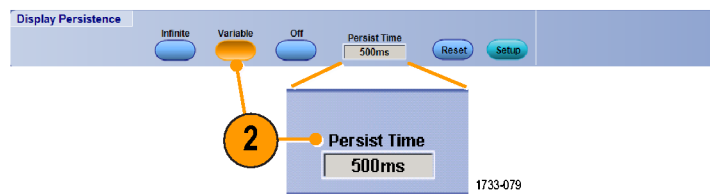
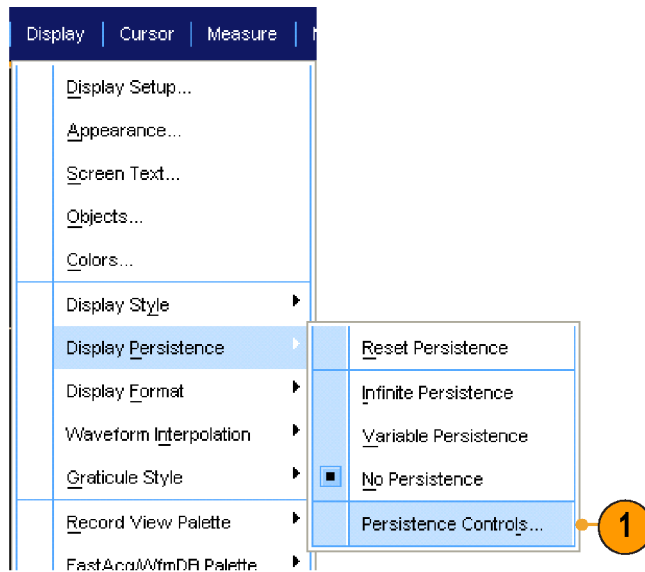

Setting the display format

The instrument can display waveforms in two different formats. Choose the format that best suits your needs.

Select **Display >Display Format**.

- Select **YT** format to show a signal amplitude as it varies over time.
- Select **XY** format to compare the amplitude of waveform records point by point:

The following channels are compared on instruments without ATI channels:

Ch 1 (X) and Ch 2 (Y),

Ch 3 (X) and Ch 4 (Y),

Ref 1 (X) and Ref 2 (Y),

Ref 3 (X) and Ref 4 (Y)

The following channels are compared on instruments with ATI channels:

Ch 1 (X) and Ch 3 (Y),

- Select **XYZ** format to compare the voltage levels of the Ch 1 (X) and Ch 2 (Y) waveform records point by point as in XY format. The displayed waveform intensity is modulated by the Ch 3 (Z) waveform record. XYZ format is triggered. A -5 division signal (including position and offset) on Ch 3 produces a blank screen; a +5 division signal produces full intensity.

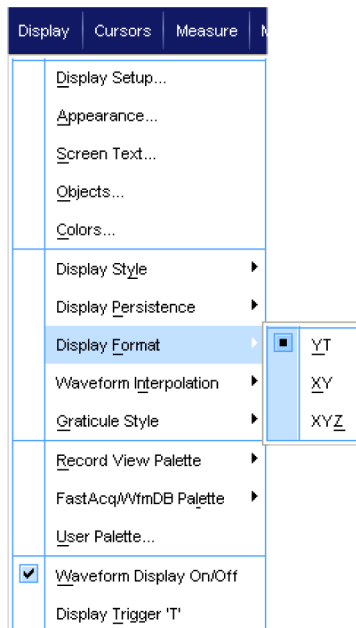

2617-073

Quick tips

- XY format is particularly useful for studying phase relationships such as Lissajous Patterns.
- XY format is a dot-only display, although it can have persistence. The Vector style selection has no effect when you select XY format.

Selecting the waveform interpolation

Select **Display >Waveform Interpolation**, and then select one of the following:

- Sin(X)/X interpolation computes record points using a curve fit between the actual samples acquired.
- Linear interpolation computes record points between actual acquired samples by using a straight line fit.

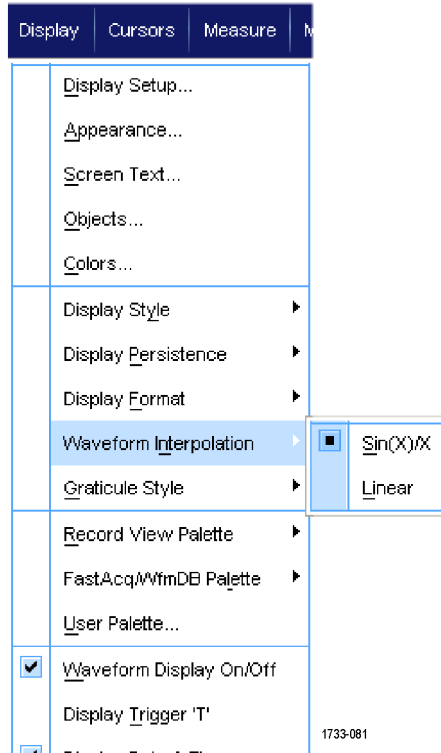

Quick tips

- Sin(X)/X interpolation is the default interpolation mode. It requires fewer actual sample points than linear interpolation to accurately represent the waveform.

Adding screen text

1. Select **Display > Screen Text**.

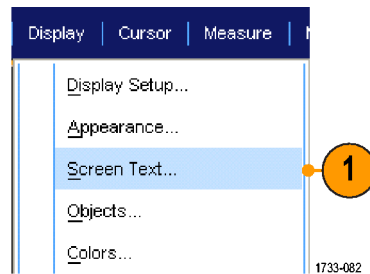

2. Enter up to eight independent lines of text.
3. Click **Text Off** or **On** to turn the text display on and off.
4. Click **Font** or **Color** to select the font and color of the screen text.
5. Click **Controls** to open the Text Properties control window for positioning of the text on the display.
6. Click **Clear** to erase the entire text of the selected line.

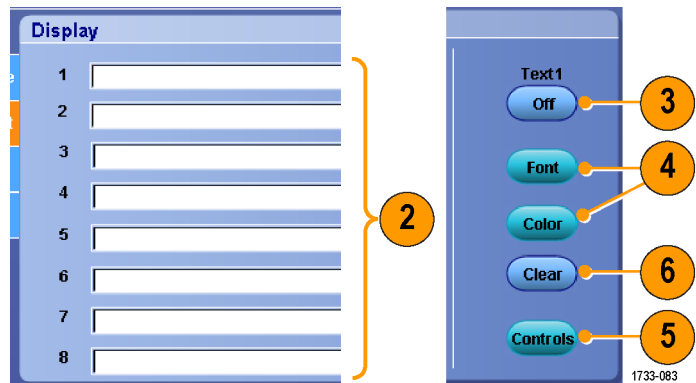

Quick tips

- Click and drag screen text to reposition it on the screen.
- You can also label waveforms and buses. See [Setting up a bus](#) on page 62.

Setting the graticule style

To set the graticule style, select **Display > Graticule Style**, and then select one of the following styles:

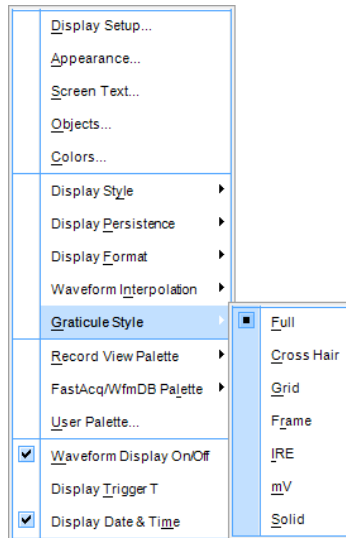

Use for quick estimate of waveform parameters.

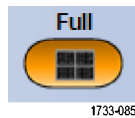

Use for full-screen measurements with cursors and automatic readouts when cross-hairs are not needed.



Use for making quick estimates of waveforms while leaving more room for automatic readouts and other data.



Use with automatic readouts and other screen text when display features are not needed.

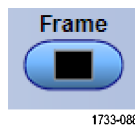

Use for NTSC video signals.



Use for video signals other than NTSC

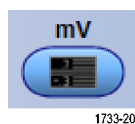

Solid is similar to Full, but the grid, cross hairs, and frame are drawn using solid lines.



Setting the trigger level marker

1. Select **Display > Objects...**
2. Select one of the following:
 - **Short** displays a short arrow on the side of the graticule.
 - **Long** displays a horizontal line across the graticule.
 - **Off** turns off the trigger level marker.

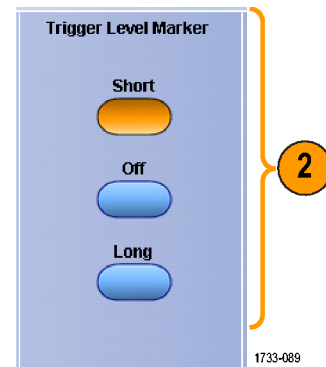
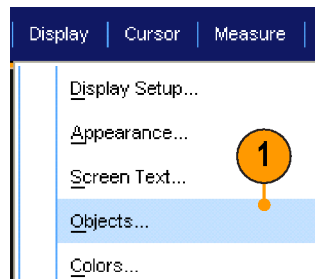

Displaying the date and time

1. Select **Display > Objects...**
2. Toggle the display of the date and time on the graticule. Use the Utilities menu to set the date and time.

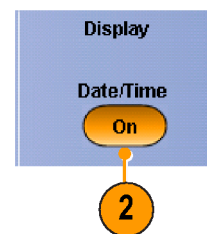
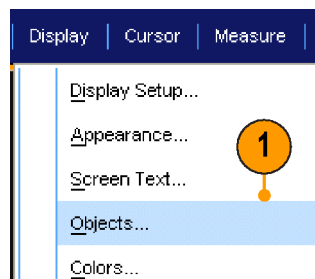

Using the color palettes

Select **Display > Record View Palette** or **FastAcq/WfmDB Palette**, and then select one of the following color schemes for the waveform and graticule:

- Normal displays hues and lightness levels for best overall viewing. The color of each channel waveform matches the color of the corresponding Auxiliary Front Panel vertical knob.
- Temperature Grading displays areas of the waveform with the highest sample density in red shades. The areas of lowest sample density appear in blue shades.
- Monochrome Green displays areas of the waveform with the highest sample density in lighter green shades. The areas of lowest sample density appear in darker green shades. It most closely resembles analog oscilloscope displays.

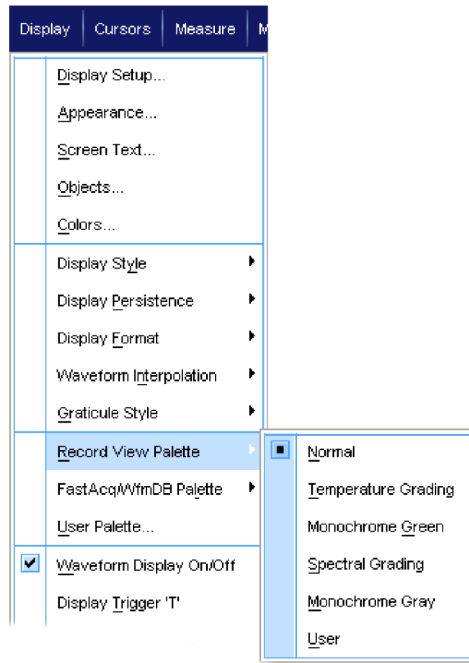

- Spectral Grading displays areas of the waveform with the highest sample density in blue shades. The areas of lowest sample density appear in red shades.
- Monochrome Gray displays areas of the waveform with the highest sample density in lighter gray shades. The areas of lowest sample density appear in darker gray shades.
- User displays the waveform in a user-defined color.

Quick tips

- Choose one of the color grading palettes in the **Display > Colors** control window to see different sample densities represented in different colors.
- There are two color palettes, one for Record View and one for FastAcq/WfmDB.

Setting reference waveform colors

Select **Display > Colors...**, and then select one of the following:

- Default uses the default system color for reference waveforms.
- Inherit uses the same color for the reference waveform as the original waveform.

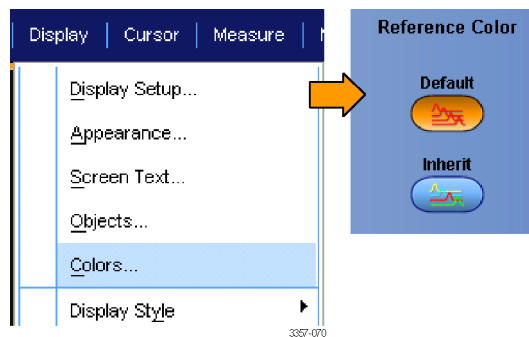

Setting math waveform colors

Select **Display > Colors...**, and then select one of the following:

- Default uses the default system color for math waveforms.
- Inherit uses the same color for the math waveform as the lowest numbered channel waveform the math function is based on.

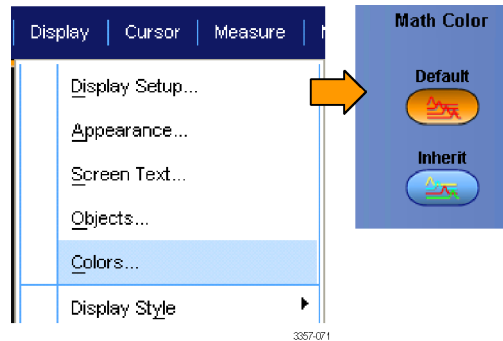

Quick tips

- The default color for math and reference waveforms are different for each waveform.

Using MultiView zoom

Use the MultiView Zoom function to magnify a waveform vertically, horizontally, or in both dimensions. Zoomed waveforms can also be aligned, locked, and automatically scrolled. Scale and Position affect only the display, not the actual waveform data.

1. If **MultiView Zoom** is off, select **Horiz/Acq > Zoom Setup...** and click **Zoom** and then **Controls** or push **MultiView Zoom** on the Auxiliary Front Panel to split the screen and add a zoom graticule.

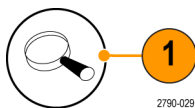

2. Push **HORIZ** or **VERT** to select which axis to magnify in the zoom graticule. Use the multipurpose knobs to adjust scale and position of the magnified waveform.

In this example the main graticule is the top half of the graticule and the zoomed graticule is the bottom half of the graticule.

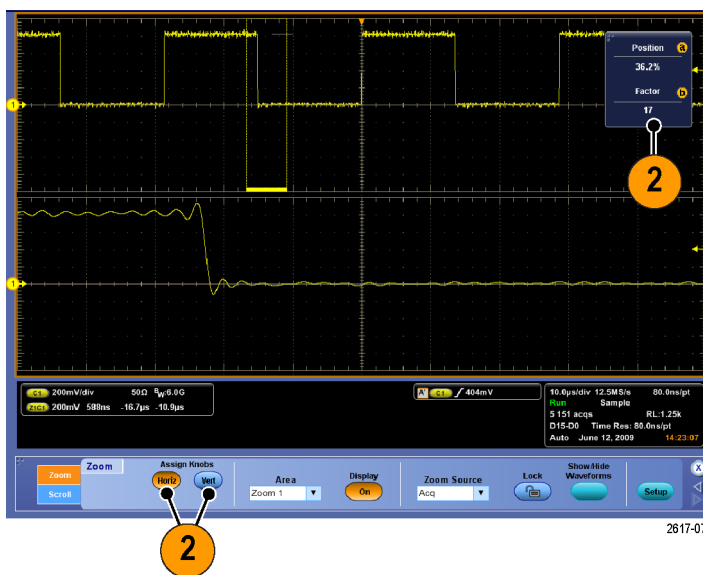

NOTE. You can hide or display zoomed waveforms by pressing **Show/Hide Waveforms** and then checking which zoomed waveforms to display.

3. To adjust the zoom graticule size, select **Zoom Graticule Size** from either the **Vertical** or **Horiz/Acq** menus.
4. If **MultiView Zoom** is on but the readouts are not attached to the zoom controls, press the **MultiView Zoom** button to attach the readouts to the zoom controls. Press the **MultiView Zoom** button again to turn zoom off.

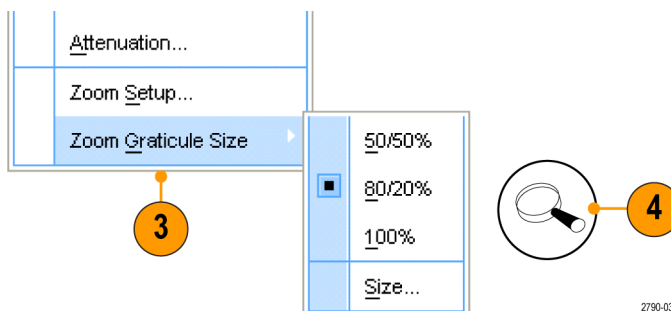

Quick tips

- Use the **Zoom Setup** menu to change the graticule size of the zoomed waveform.

Zooming in multiple areas

When you want to view and compare multiple areas of one record at the same time, use the following procedure.

1. Click and drag a box around the area of the waveform that you want to zoom.
2. Select **Zoom 1 On**.

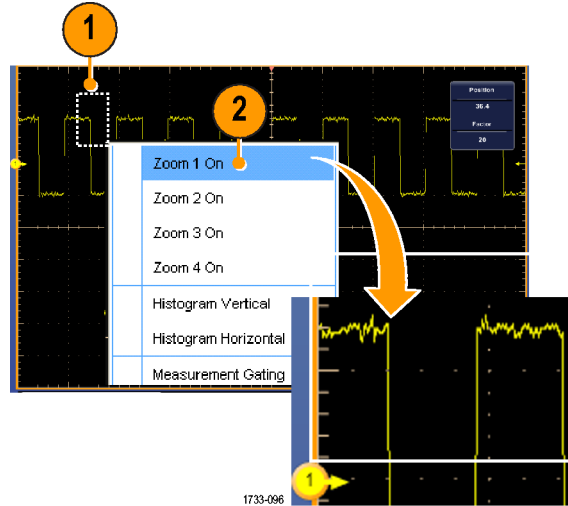

3. Click and drag a box around another area of the waveform that you want to zoom, and then select **Zoom 2 On**.

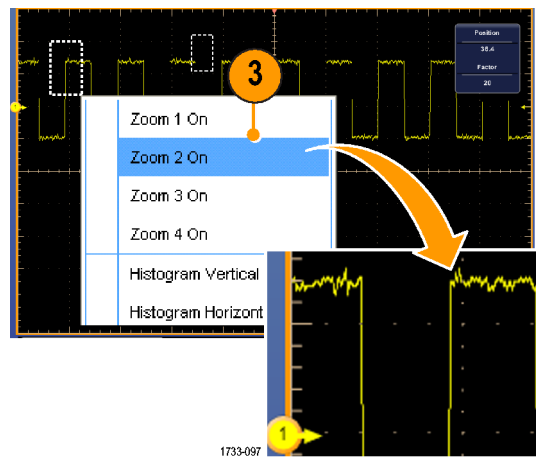

4. To adjust the zoomed area horizontally, click the horizontal marker below the Zoom box to select the zoomed area.
5. Use the optional multipurpose knobs or double click the readout and use the keypad to adjust the horizontal position and factor of the selected zoom area.

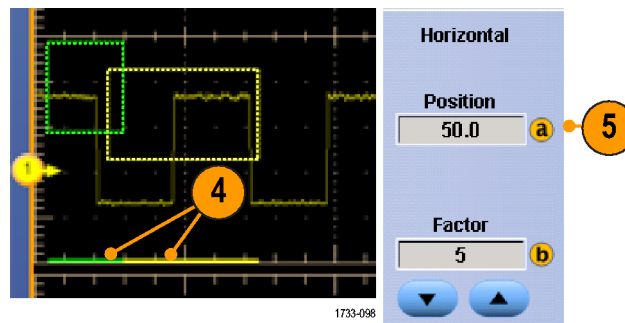

6. To adjust the zoomed area vertically, select **Vertical > Zoom Setup...**, click a vertical field, and then use the optional multipurpose knobs or double click the readout and use the keypad to adjust the Vertical Position and Factor.

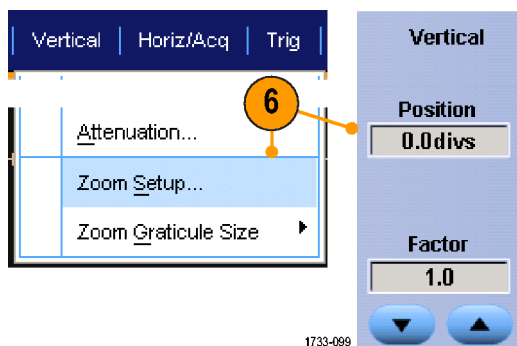

Quick tips

- To clear the zoom area, click **Position Factor Reset** from the Zoom Setup control window.
- Turn each zoom display on and off from the Zoom Setup control window.
- Push the **MultiView Zoom** button once or twice to toggle all zoom displays on and off.
- To reposition the zoomed area horizontally, click and drag the horizontal marker at the bottom of the zoom box.

Lock and scroll zoomed waveforms

1. To use Lock and Scroll select **Zoom Setup...** from either the Vertical or Horiz/Acq menu, and then select the **Lock and Scroll** tab.

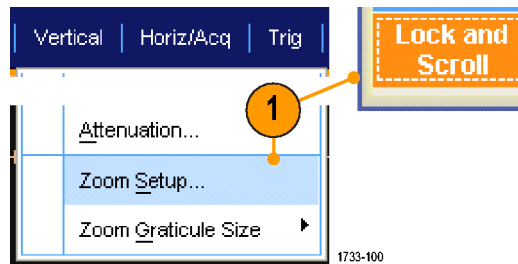

2. To scroll a single zoomed area, select a **Zoom 1-4** check box, and then click an Auto Scroll button.

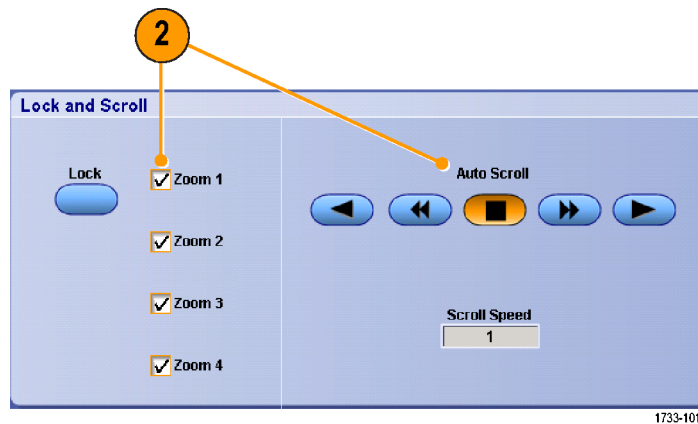

3. To scroll multiple zoomed areas simultaneously, click **Lock**, and then select the **Zoom1-4** check boxes that you want to scroll through.

Locking the zoomed areas locks in their relative horizontal position. Changing the horizontal position of one locked and zoomed area changes them all.

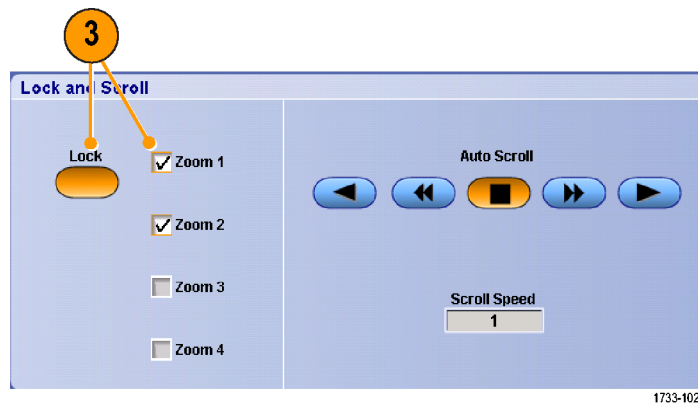

Quick tips

- When multiple zoom areas are selected but not locked, the zoom area with the highest number will autoscroll, while the other zoom areas remain stationary.

Hide waveforms in the zoomed window

1. To hide or view waveforms, select **Zoom Setup...** from either the Vertical or Horiz/Acq menu.
2. Select a **Zoom** tab, and then press **Show/Hide Waveforms**.

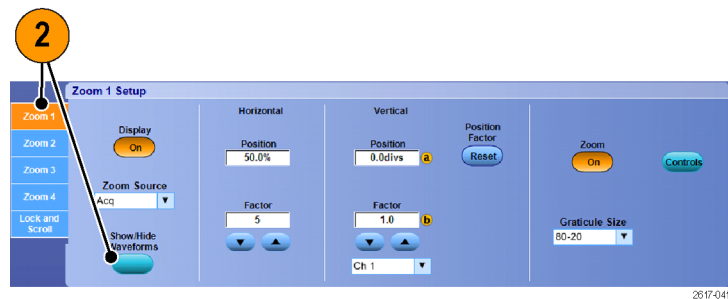
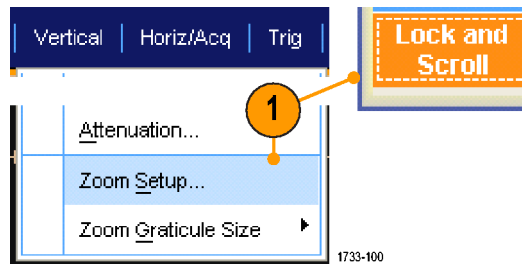

3. Select the zoomed area that contains the waveform you want to show or hide.
4. Uncheck the channel, math, or reference waveform you want to hide.

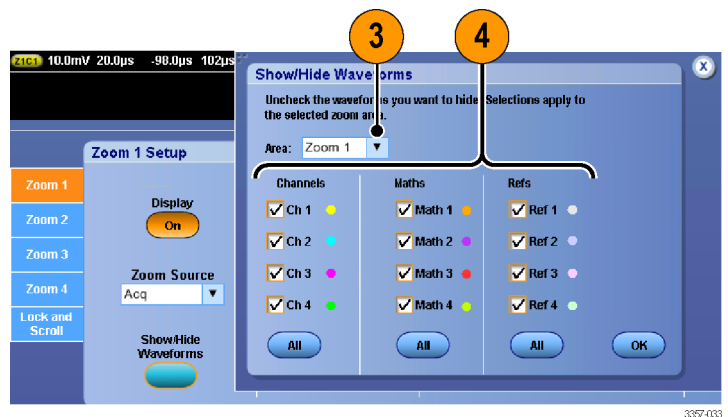

Searching and marking waveforms

You can mark locations of interest in the acquired waveform. These marks help you limit your analysis to particular regions of the waveform. You can mark areas of the waveform automatically, if they meet some special criteria, or you can manually mark each item of interest. You can jump from mark to mark (area of interest to area of interest). You can automatically search and mark many of the same parameters that you can trigger on. Many search parameters do not have the time limits as triggers. You can search on math and reference waveforms. You can find all of the acquired events of a certain type.

Search marks provide a way to mark a waveform region for reference. Set marks automatically with search criteria. Search for and mark regions with particular edges, pulse widths, runts, logic states, rise/fall times, setup and hold violations, and bus search types.

To manually set and clear (delete) marks:

1. Turn on **Multiview Zoom**. Zoom 1 is used with marks.
See *Using MultiView zoom* on page 107.

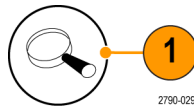

2. Select **Analyze > Search**.

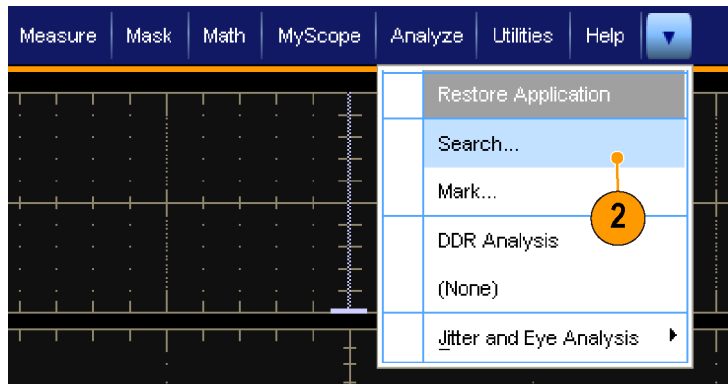

3. Move (the zoom box) to the area on the waveform where you want to set (or clear) a search mark by selecting the bottom of the zoom box and dragging it to the desired location or by turning a multipurpose knob on the Auxiliary Front Panel.

Push the Next (→) or Prev (←) arrow button to jump to an existing mark.

4. Push **Set Clr** or the Auxiliary Front Panel **Set/Clear** button.

If no search mark is at the screen center, the instrument will add one.

When a mark is created, the horizontal zoom factor is saved. When you use Next or Prev to move between marks, the zoom factor is restored.

When a mark is created, the horizontal zoom factor is saved. When you use Next or Prev to move between marks, the zoom factor is restored.

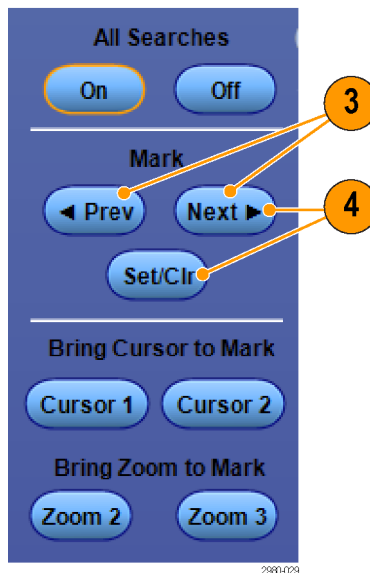

- Investigate your waveform by moving from search mark to search mark. Use the Next (→) or Prev (←) arrow button to jump from one marked location to another, without adjusting any other controls.
- Delete a mark. Push the Next (→) or Prev (←) arrow button to jump to the mark you want to clear. To remove the center-positioned mark, push the **Set Clr** or the Auxiliary Front Panel **Set/Clear** button. It works on both manually and automatically created marks.

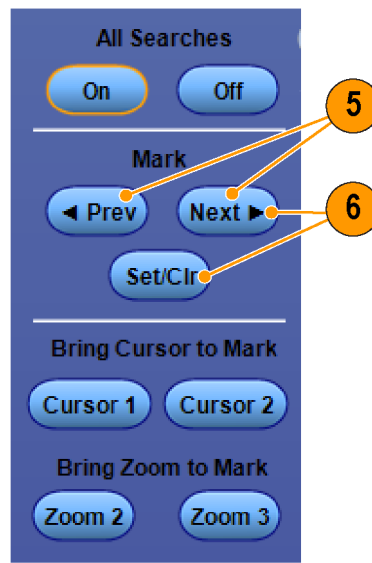

To automatically set and clear (delete) search marks

1. Push **Search** or select **Analyze > Search**.

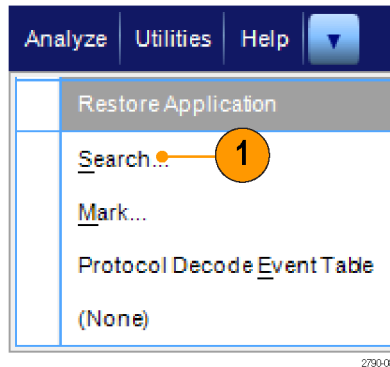

2. Select the desired search type from the menu.
The search menu is similar to the trigger menu.
Serial bus searches are optional.

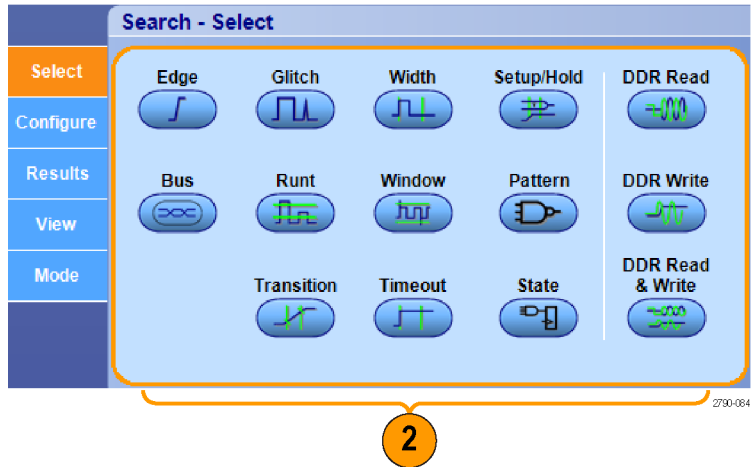

3. Set up your search from the Configure tab. To copy the trigger setup or a search setup, press Copy Settings.
4. From the Copy Settings window, select where to copy the settings from and where to copy the settings to. Press Copy and then Close.

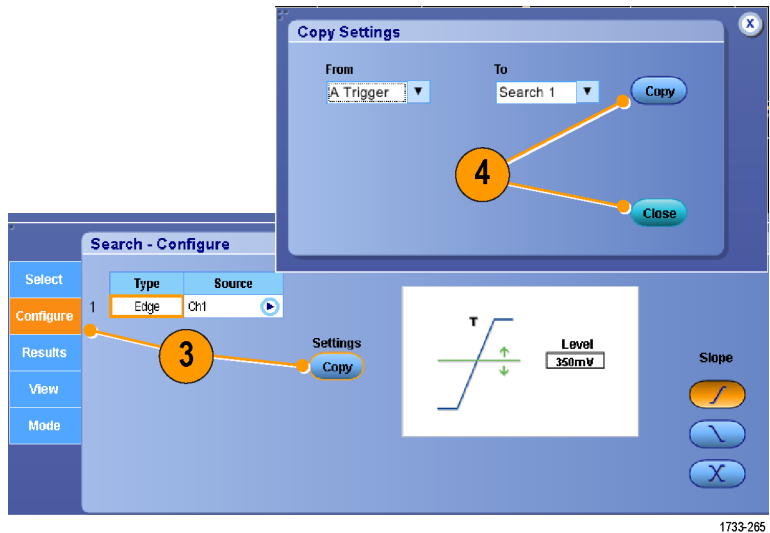

- To modify the current search setup, adjust the displayed controls. Displayed controls vary depending on the selected search.

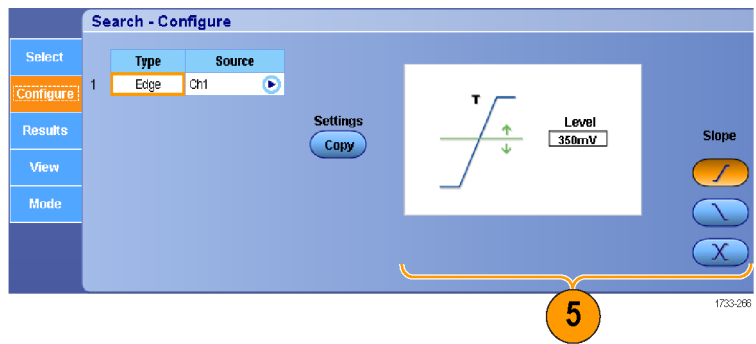

- If not already on, press **All Searches** to toggle search to on.

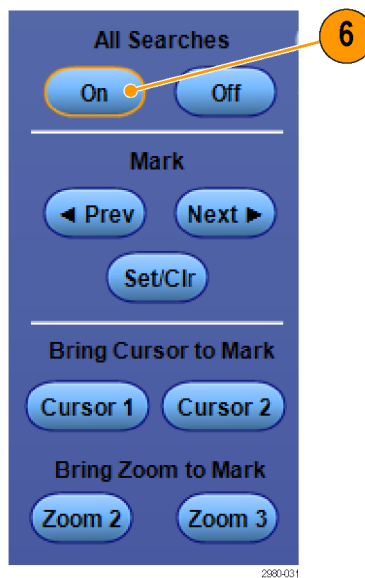

- On the screen, triangles show the location of automatic marks and triangles with a white outline show the custom (user-defined) locations. These appear on both normal and zoomed waveform views.

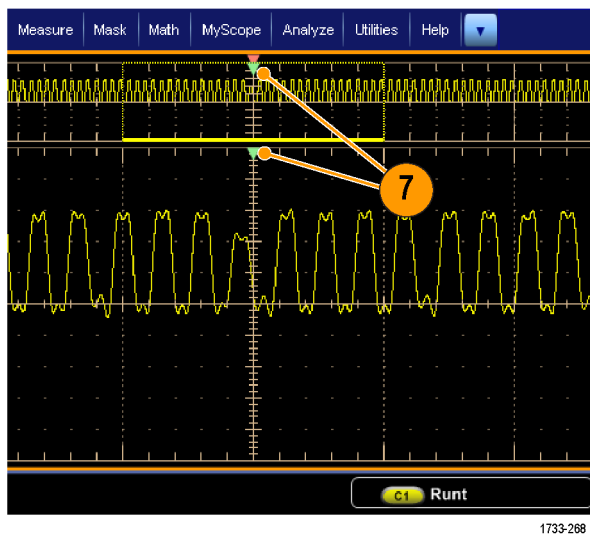

- Quickly investigate your waveform by moving from mark to mark with the Next (→) or Prev (←) arrow button. No other adjustments are needed.

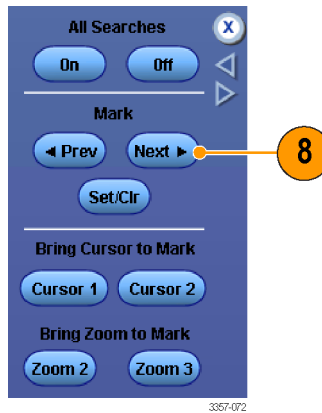

- To toggle between the display of search events counts or Marks time, select the **Results** tab and press **View Count**.
- To export the Mark Table to a file, press **All Marks Export**.

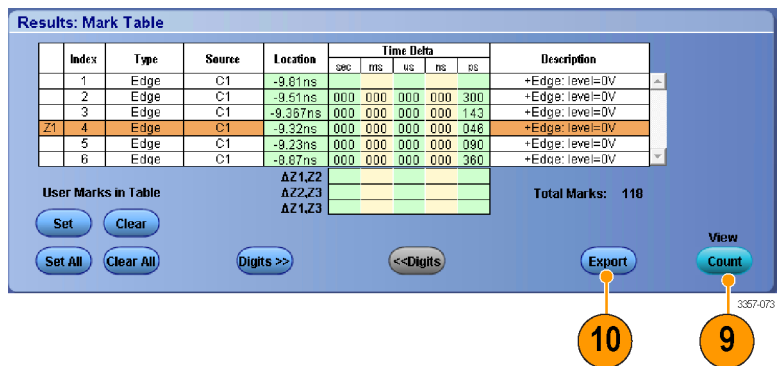

- To convert a mark or all marks to user marks, press Search Marks **Save** or **Save All**.
- To remove the currently highlighted row from the Mark Table, press Search Marks **Clear**.
- To toggle between showing mark locations in engineering notation or in high precision form, press **Digits**.

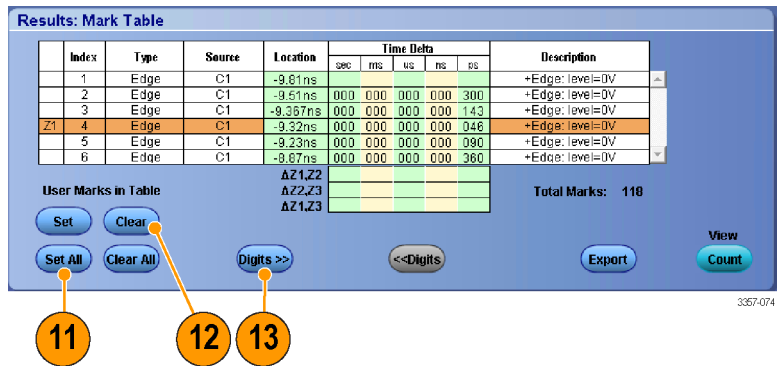

- To toggle the display of mark triangles on and off, select the **View** tab and press **Show Marks**.

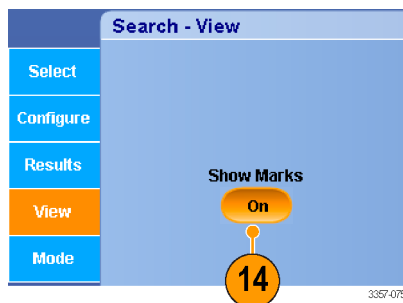

15. To stop acquisitions if a match is found, select the **Mode** tab and check **Stop Acquisition if event found**.

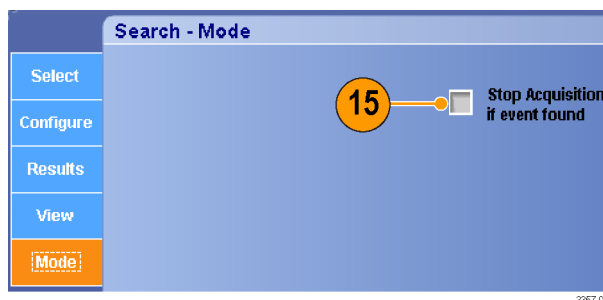

Quick tips

- Search is performed only on acquired data. Set up the instrument to acquire the data you are searching for.
- Set the sample rate so the search event is discernible. You can search for a glitch that is wider than a couple of sample intervals.
- You can copy trigger settings to search for other locations in your acquired waveform that meet the trigger conditions. You can copy search settings to your trigger.
- Edge search marks are created without zoom factors. Other search types create marks with an appropriate zoom factor.
- Pressing Bring Zoom to Mark **Zoom 2** or **Zoom 3** displays the corresponding zoom view with the same zoom parameters as Zoom 1.
- Custom (User) marks are saved with the waveform when the waveform is saved and when the setup is saved.
- Automatic search marks are not saved with the waveform when the waveform is saved. However, the search criteria are saved in the saved setup, so you can easily recapture the marks by reusing the search function.

Search includes the following search capabilities:

Search	Description
Edge	Searches for edges (rising or falling) with a user-specified threshold level.
Glitch	Searches for pulses narrower (or wider) than the specified width, or ignores glitches narrower (or wider) than the specified width.
Width	Searches for positive or negative pulse widths that are $>$, $<$, $=$, or \neq a user-specified pulse width.
Setup & Hold	Search for violations of user-specified setup and hold times.
Runt	Searches for positive or negative pulses that cross one amplitude threshold but fail to cross a second threshold before crossing the first again. Search for all runt pulses or only those with a duration $>$, $<$, $=$, or \neq a user-specified time.
Window	Searches for a signal that is entering or leaving the threshold window. Qualify the search in terms of time by using the When Wider option, or by the logical state of other channels using the When Logic option.
Pattern	Search for a logic pattern (AND, OR, NAND, or NOR) across multiple waveforms with each input set to either High, Low, or Don't Care. Search for when the event goes true, goes false, or stays valid for $>$, $<$, $=$, or \neq a user-specified time. Additionally, you must define one of the inputs as a clock for synchronous (state) searches.
Transition	Search for rising and/or falling edges that are $>$, $<$, $=$, or \neq a user-specified time.
Timeout	Searches for no pulse in a specified time.
State	Searches for when all of the logic inputs to the selected logic function cause the function to be True or False when the clock input changes state.

Search	Description
DDR Read	Searches for DDR read pulses. Requires option DDRA.
DDR Write	Searches for DDR write pulses. Requires option DDRA.
DDR Read and Write	Searches for DDR read and write pulses. Requires option DDRA.
Bus	Parallel: Search for a binary or hex value. Custom: search using your custom decoder.

Using a visual search

A visual search is performed with the same settings as the main trigger. The results of a visual search are displayed as marks with a color distinct from those of an Analyze search. Do the following steps to set up a visual search.

1. Set up pinpoint triggers. See [Choosing a trigger type](#) on page 75.
2. Set up a visual trigger. See [Triggering using visual triggers \(Visual triggering\)](#) on page 89.
3. Click **Mark All Trigger Events in Record**.

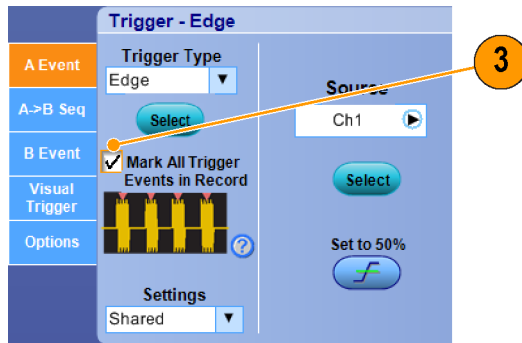

4. Visual Trigger areas are displayed in blue.
5. Visual Search areas are displayed in green.

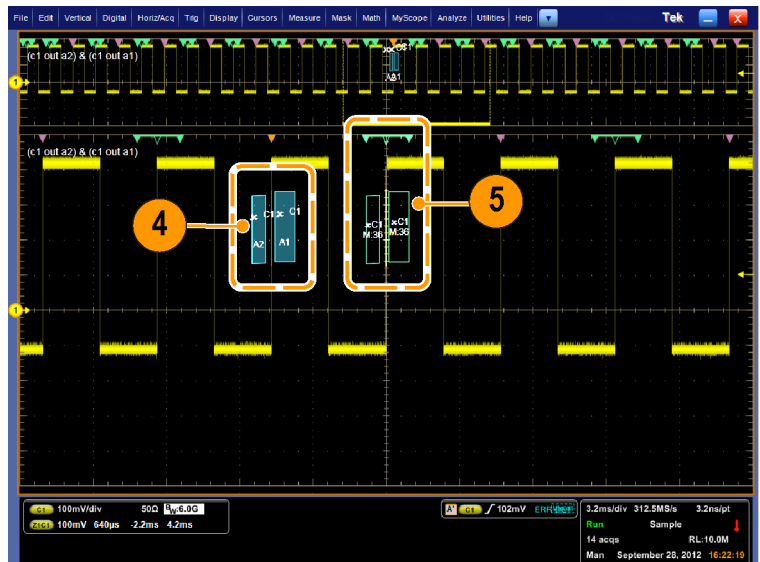

6. Only the active visual search area is displayed. Press the Mark **Next** and the Mark **Prev** buttons to move the active area to other visual search areas.

Use the other Analyze Search control windows to control or view the results of the Visual Search.

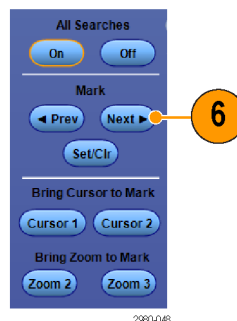

Analyzing waveforms

Your instrument features cursors, automatic measurements, statistics, histograms, math, spectral analysis, and advanced pass/fail tests to help you to analyze waveforms. This section contains concepts and procedures for analyzing waveforms. Detailed information is available in the online help.

Taking automatic measurements

1. Select **Measure > Measurement Setup...**

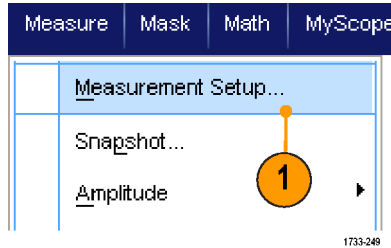

2. Select the channel, math or reference waveform that you want to measure.
3. Using the tabs, select measurements in five different categories.

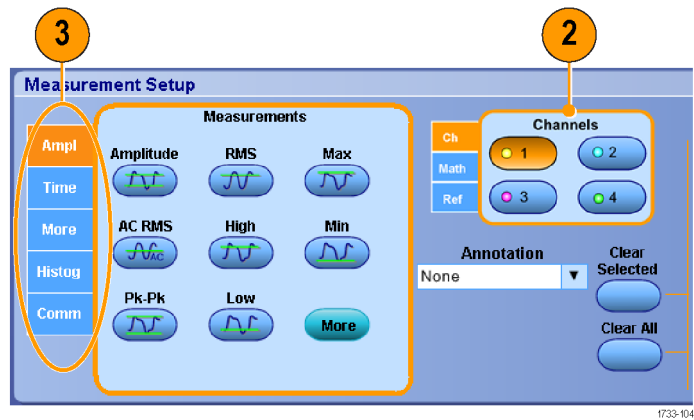

4. To remove all measurements, click **Clear All**.
5. To remove multiple measurements, click and drag to select the measurements, and then click **Clear Selected**.

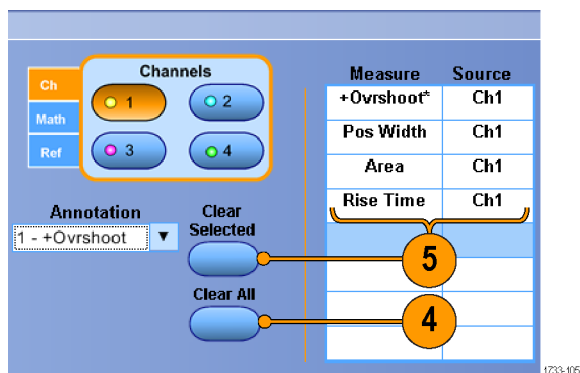

You can also choose a measurement for the selected waveform directly in the Measure menu. See [Automated measurement selections](#) on page 122.

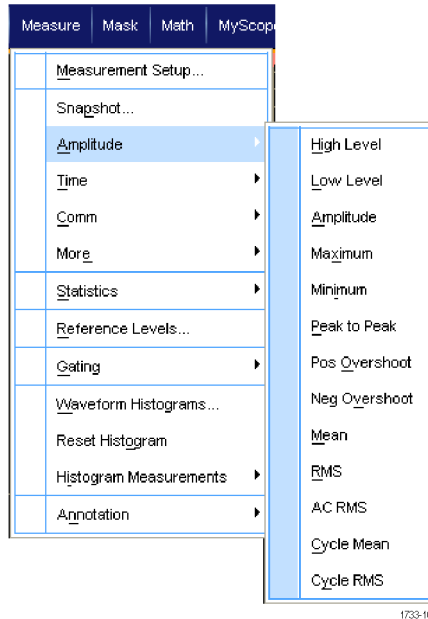

Quick tips

- In roll mode, measurements are not available until after you stop the acquisition.



WARNING. If there is vertical clipping, there may be a dangerous voltage on the probe tip, but the readout will indicate a low voltage. A  symbol appears in the measurement readout if a vertical clipping condition exists. Automatic amplitude-related measurements where the signal is vertically clipped produce inaccurate results. Clipping also causes inaccurate amplitude values in waveforms that are stored or exported for use in other programs. If a math waveform is clipped, it will not affect amplitude measurements on that math waveform.

Automated measurement selections

The following tables list each automated measurement by category: amplitude, time, histogram, communication, or more. See [Taking automatic measurements](#) on page 121.

Table 8: Amplitude measurements

Measurement	Description
Amplitude	The high value less the low value measured over the entire waveform or gated region.
High	This value is used as 100% whenever high reference, mid reference, or low reference values are needed, such as in fall time or rise time measurements. It is calculated using either the min/max or histogram method. The min/max method uses the maximum value found. The histogram method uses the most common value found above the midpoint. This value is measured over the entire waveform or gated region.
Low	This value is used as 0% whenever high reference, mid reference, or low reference values are needed, such as in fall time or rise time measurements. It is calculated using either the min/max or histogram method. The min/max method uses the minimum value found. The histogram method uses the most common value found below the midpoint. This value is measured over the entire waveform or gated region.

Measurement	Description
RMS	The true Root Mean Square voltage over the entire waveform or gated region.
AC RMS	The true Root Mean Square voltage over the measurement region.
Max	The most positive peak voltage. Max is measured over the entire waveform or gated region.
Min	The most negative peak voltage. Min is measured over the entire waveform or gated region.
Pk-Pk	The absolute difference between the maximum and minimum amplitude in the entire waveform or gated region.
Cycle RMS	The true Root Mean Square voltage over the first cycle in the waveform or the first cycle in the gated region.
+Overshoot	This is measured over the entire waveform or gated region and is expressed as: Positive Overshoot = $((\text{Maximum} - \text{High}) / \text{Amplitude}) \times 100\%$.
-Overshoot	This is measured over the entire waveform or gated region and is expressed as: Negative Overshoot = $((\text{Low} - \text{Minimum}) / \text{Amplitude}) \times 100\%$.
Mean	The arithmetic mean over the entire waveform or gated region.
Cycle Mean	The arithmetic mean over the first cycle in the waveform or the first cycle in the gated region.

Table 9: Time measurements

Measurement	Description
Rise Time	The time required for the leading edge of the first pulse in the waveform or gated region to rise from the low reference value (default = 10%) to the high reference value (default = 90%) of the final value.
Fall Time	The time required for the falling edge of the first pulse in the waveform or gated region to fall from the high reference value (default = 90%) to the low reference value (default = 10%) of the final value.
Pos Width	The distance (time) between the mid reference (default 50%) amplitude points of a positive pulse. The measurement is made on the first pulse in the waveform or gated region.
Neg Width	The distance (time) between the mid reference (default 50%) amplitude points of a negative pulse. The measurement is made on the first pulse in the waveform or gated region.
+ Duty Cyc	The ratio of the positive pulse width to the signal period expressed as a percentage. The duty cycle is measured on the first cycle in the waveform or gated region.
- Duty Cyc	The ratio of the negative pulse width to the signal period expressed as a percentage. The duty cycle is measured on the first cycle in the waveform or gated region.
Period	The time required to complete the first cycle in a waveform or gated region. Period is the reciprocal of frequency and is measured in seconds.
Freq	The frequency of the first cycle in a waveform or gated region. Frequency is the reciprocal of the period; it is measured in Hertz (Hz) where one Hz is one cycle per second.
Delay	The time between the mid reference (default 50%) amplitude point of two different waveforms.

Table 10: More measurements

Measurement	Description
Area	The area over the entire waveform or gated region in volt-seconds. Area measured above ground is positive; area measured below ground is negative.
Cycle Area	The area over the first cycle in the waveform or the first cycle in the gated region expressed in volt-seconds. The area above the common reference point is positive while the area below the common reference point is negative.
Phase	The amount of time that one waveform leads or lags another waveform, expressed in degrees where 360° contains one waveform cycle.
Burst Width	The duration of a burst (a series of transient events) and is measured over the entire waveform or gated region.

Table 11: Histogram measurements

Measurement	Description
Wfm Ct	Displays the number of waveforms that have contributed to the histogram.
Hits in Box	Displays the number of points in or on the histogram box.
Peak Hits	Displays the number of points in the largest bin of the histogram.
Median	Displays the middle point of the histogram box. Half of all acquired points within or on the histogram box are less than this value and half are greater than this value.
Max	Displays the voltage of the highest nonzero bin in vertical histograms or the time of the rightmost nonzero bin in the horizontal histograms.
Min	Displays the voltage of the lowest nonzero bin in vertical histograms or the time of the leftmost nonzero bin in the horizontal histograms.
Pk-Pk	Displays the peak-to-peak value of the histogram. Vertical histograms display the voltage of the highest nonzero bin minus the voltage of the lowest nonzero bin. Horizontal histograms display the time of the rightmost nonzero bin minus the time of the leftmost nonzero bin.
Mean	Measures the average of all acquired points within or on the histogram box.
Std Dev	Measures the standard deviation (Root Mean Square (RMS) deviation) of all acquired points within or on the histogram box.
Mean \pm 1 Std Dev	Displays the percentage of points in the histogram that are within one standard deviation of the histogram mean.
Mean \pm 2 Std Dev	Displays the percentage of points in the histogram that are within two standard deviations of the histogram mean.
Mean \pm 3 Std Dev	Displays the percentage of points in the histogram that are within three standard deviations of the histogram mean.

Table 12: Communication measurements

Measurement	Description
Ext Ratio	The ratio of eye top to base. This measurement only works for waveform database or a reference waveform saved in waveform database mode.
Ext Ratio %	The ratio of eye top to base expressed as a percentage. This measurement only works for waveform database or a reference waveform saved in waveform database mode.

Measurement	Description
Ext Ratio (dB)	The ratio of eye top to base expressed in decibels. This measurement only works for waveform database or a reference waveform saved in waveform database mode.
Eye Height	The measurement of the eye height in volts.
Eye Width	The measurement of eye width in seconds.
Eye Top	The top value used in the extinction ratio measurements.
Eye Base	The base value used in the extinction ratio measurements.
Crossing %	The eye crossing point expressed as a percentage of eye height.
Jitter P-P	The peak-to-peak value for the edge jitter in the current horizontal units.
Jitter RMS	The RMS value of the edge jitter in the current horizontal units.
Jitter 6 Sigma	Six times the RMS value of the edge jitter in the current horizontal units.
Noise P-P	The peak-to-peak value of the noise of the top or base of the signal as specified by you.
Noise RMS	The RMS value of the noise of the top or base of the signal as specified by you.
S/N Ratio	The ratio of the signal amplitude to the noise of the top or base of the signal as specified by you.
Cyc Distortion	The peak-to-peak time variation of the first eye crossing measured at the Mid Ref as a percent of the eye period.
Q-Factor	The ratio of eye size to noise.

Customizing an automatic measurement

Customize automatic measurements by using gating, modifying measurement statistics, or adjusting the measurement reference levels.

Gating

Use Gating to confine the measurement to a certain part of a waveform.

1. Select **Measure > Gating > Gating...**
2. Position the gates by doing one of the following:
 - Click **Cursor** to set the gated area to the area between the cursors.
 - Click **Zoom (1-4)** to set the gated area to the Zoom (1-4) graticule.

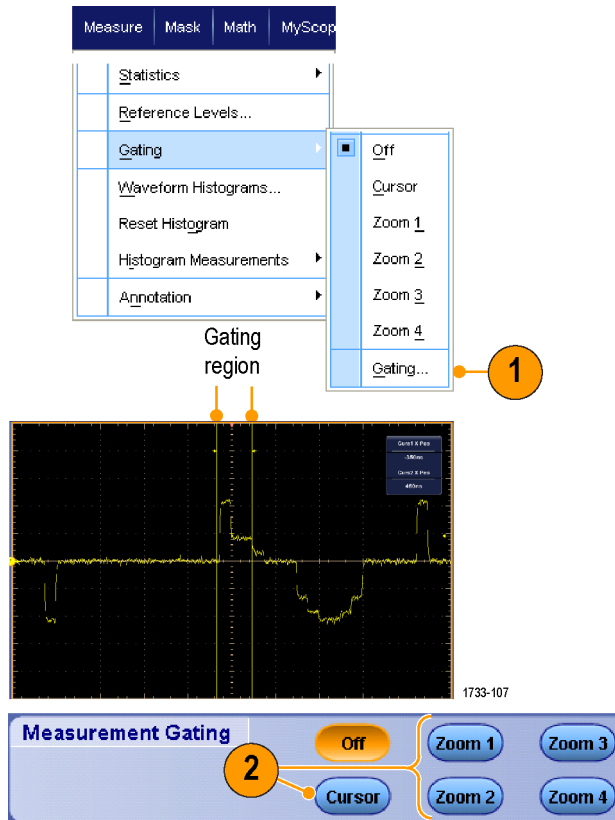

Statistics

Statistics turn on automatically with measurements. Statistics characterize the stability of the measurement.

1. To change the statistics that are displayed, select **Measure > Statistics**, and then select **Mean** or **All**. (All includes min, max, mean, standard deviation, and population.)
2. To remove statistics select **Off**.

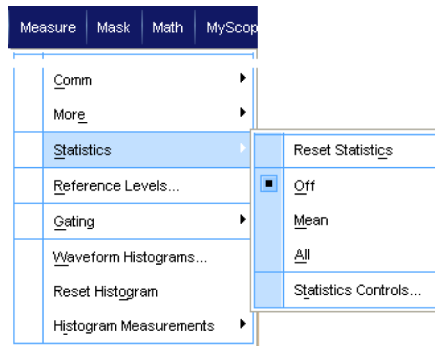

NOTE. Placing the cursor over a measurement displays a higher resolution version of the measurement.

	Value	Mean	Min	Max	St Dev	Count	Info
C1 Ovrshft	350%	350	350	350	0.0	1.0	
C1 Pos Wid	2.5µs	2.5µ	2.5µ	2.5µ	0.0	1.0	
C1 Area	81.2µVs	81.2µ	81.2µ	81.2µ	0.0	1.0	
C1 Rise	400ns	400n	400n	400n	0.0	1.0	

1733-108

Snapshot

To see a one-time view of all valid measurements, select **Measure > Snapshot**.

NOTE. If the setup for a measurement is invalid, the results of that measurement is displayed as 3 question marks.

The screenshot shows the 'Measurement Setup...' menu with 'Snapshot...' selected and highlighted with a red circle and the number '1'. To the right, the 'Measurement Snapshot on Ch 1' window displays a table of measurement data.

Measurement Snapshot on Ch 1			
Period	28.72µs	Freq	34.82kHz
Pos Width	13.58µs	Neg Width	15.14µs
Burst Wid	86.00µs		
Rise Time	141.33ns	Fall Time	69.33ns
+ Duty Cyc	47.28%	- Duty Cyc	52.72%
+Overshoot	3.37%	-Overshoot	4.33%
Max	848 mV	High	820 mV
Min	-48.0mV	Low	-12.0mV
Amplitude	832 mV	Pk-Pk	836 mV
Mean	373.66mV	Cycle Mean	377.08mV
RMS	552.67mV	Cycle RMS	554.61mV
Area	37.34µVs	Cyc Area	10.83µVs

1733-253

To select between taking a snapshot of general measurements or communications measurements, select General or Comm.

The screenshot shows the 'Measurement Snapshot on Ch 1' window. On the left is a table of measurement data. On the right, the 'Measurement Context' section shows 'Base, Top Form Histogram Mode' and 'High Ref 90.0%', 'Mid Ref 50.0%', and 'Low Ref 10.0%'. Below this, the 'Snapshot Type' section has 'General' and 'Comm' buttons, with 'General' selected and highlighted with a red circle and the number '2'. A 'Setup' button is also visible.

Measurement Snapshot on Ch 1			
Period	28.72µs	Freq	34.82kHz
Pos Width	13.58µs	Neg Width	15.14µs
Burst Wid	86.00µs		
Rise Time	141.33ns	Fall Time	69.33ns
+ Duty Cyc	47.28%	- Duty Cyc	52.72%
+Overshoot	3.37%	-Overshoot	4.33%
Max	848 mV	High	820 mV
Min	-48.0mV	Low	-12.0mV
Amplitude	832 mV	Pk-Pk	836 mV
Mean	373.66mV	Cycle Mean	377.08mV
RMS	552.67mV	Cycle RMS	554.61mV
Area	37.34µVs	Cyc Area	10.83µVs

1733-250

Annotate measurements

- To annotate measurements, select **Annotation** from the Measurements setup control window. From the drop down list, select the measurement to annotate.

The screenshot shows the 'Measurement Setup' window. The 'Annotations' section is highlighted with a red circle and the number '1'. It contains a grid of measurement types: Rise Time, Pos Width, Period, Fall Time, Neg Width, Freq, +Duty Cycle, -Duty Cycle, and Delay. To the right, there are controls for 'Ch' (set to 1), 'Math', and 'Ref' (set to 3). Below these, the 'Annotation' dropdown menu is open, showing 'None', '1 - Amplitude', and '2 - Freq'.

1733-251

- To select the amount of measurement annotation detail, select **Measure > Annotation > Standard** or **Detailed**.

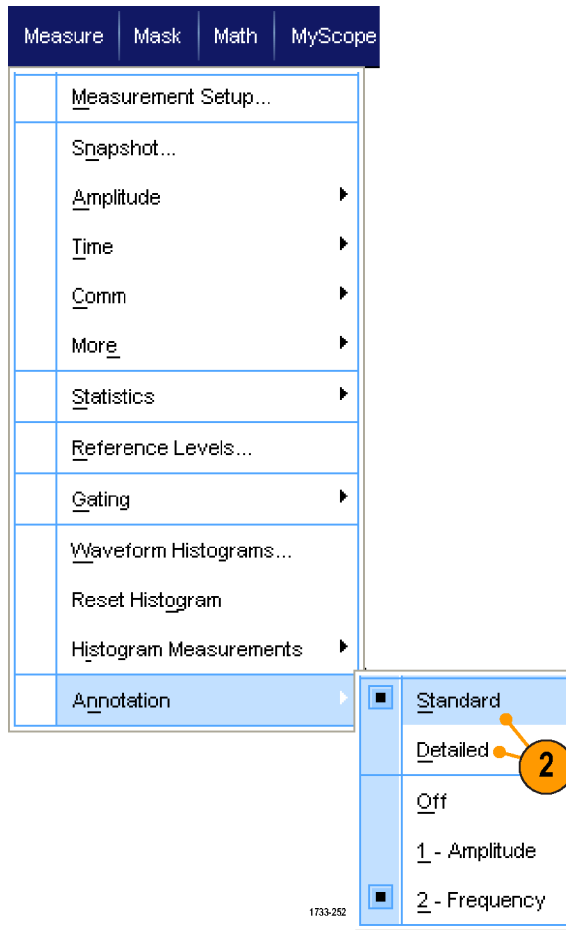

Reference levels

Reference levels determine how time-related measurements are taken.

- Select **Measure > Reference Levels...**
- Adjust the measurement reference levels to different relative or absolute values.
 - High and Low references are used to calculate rise and fall times. The default High reference is 90% and Low reference is 10%.
 - Mid reference is primarily used for measurements between edges such as pulse widths. The default level is 50%.
 - Mid2 reference is used on the second waveform specified in delay or phase measurements. The default level is 50%.

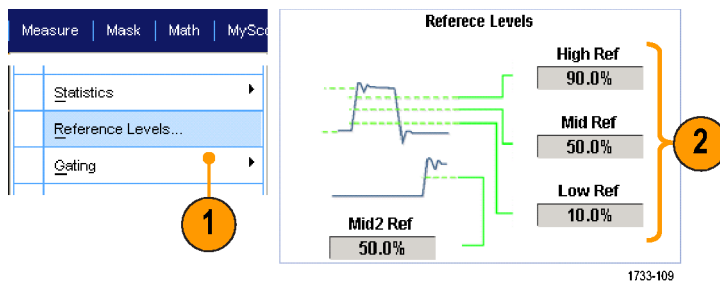

Quick tips

- To ensure accurate noise values, be sure to go to the Reference Levels Setup menu and set the signal type to Eye when measuring an Eye signal.

Taking cursor measurements

Use cursors to take manual measurements on acquired data.

1. Select **Cursors > Cursor Controls** or push **Cursors** on the Auxiliary Front Panel.

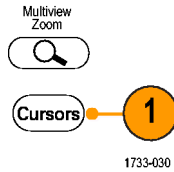

NOTE. If cursors are on but the multipurpose knob readouts are not attached to the Position controls, press the Cursors button to attach the controls to the readouts. Press the Cursors button again to turn cursors off.

2. Select the Cursor Source.
3. Select a cursor type from one of the following:

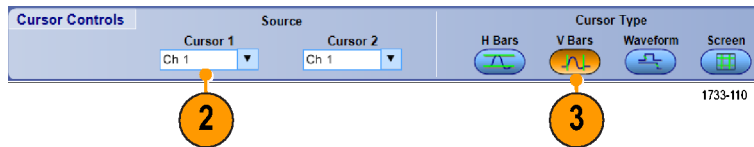

- H Bars measure amplitude (typically in volts or amperes)
- V Bars measure horizontal parameters (typically time)
- Waveform and screen cursors measure vertical and horizontal parameters simultaneously. Waveform cursors are attached to the waveform, and screen cursors float, unattached to the waveform.

4. To take measurements between two waveforms, select **Waveform**, and then select the waveform source for each cursor.

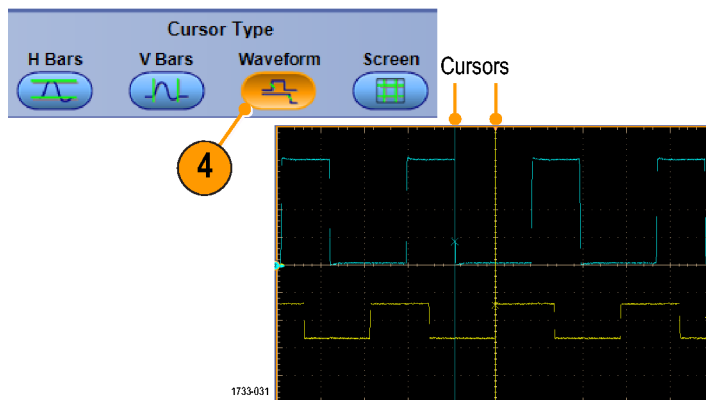

5. Select **Cursors > Cursor Position...**, and then use the multipurpose knobs to adjust the cursor position.
6. Read cursor measurement results in the display.

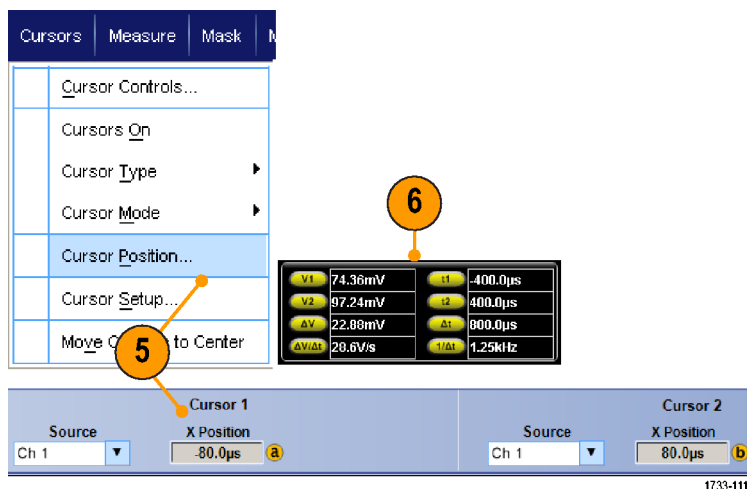

Quick tips

- Use the Cursor Track Mode to set the cursors to move in tandem. Use the Cursor Independent mode to move the cursors separately.
- If you use the zoom graticule, you can place a cursor directly on a specific waveform point to take precision measurements.
- You can also move cursors by clicking and dragging them to a new position.
- You can also move cursors to the center of the display by pressing **Move Cursors to Center**.
- You can select solid or dashed cursors.
- Vertical cursors measure the time from the trigger point to the vertical cursor.

Setting up a histogram

You can display either a vertical (voltage) or horizontal (time) histogram. Use histogram measurements to get statistical measurement data for a section of a waveform along one axis.

1. Click and drag the pointer across the segment of the waveform that you want the histogram to cover. For example, make the box for a horizontal histogram wider than it is tall.
2. Select **Histogram Vertical** or **Histogram Horizontal** from the shortcut menu.

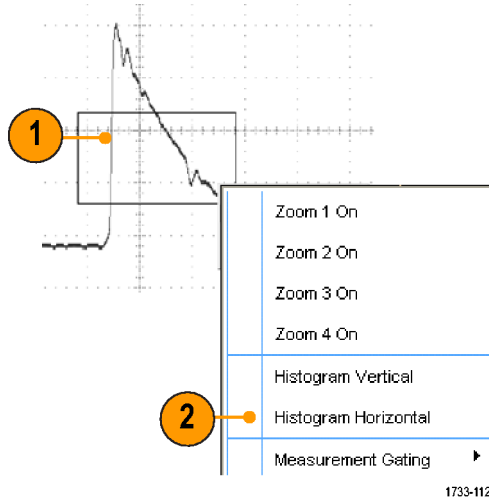

3. View the histogram at the top (for horizontal histograms) or the left edge (for vertical histograms) of the graticule.

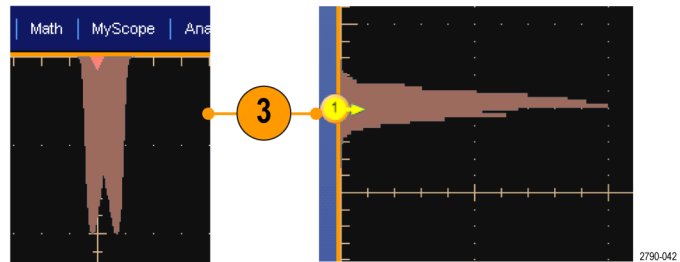

4. To make adjustments to the histogram scale or the size and location of the histogram box, select **Measure > Waveform Histograms**, and then use the Histogram Setup control window.
5. You can also take automated measurements on histogram data. See [Taking automatic measurements](#) on page 121.

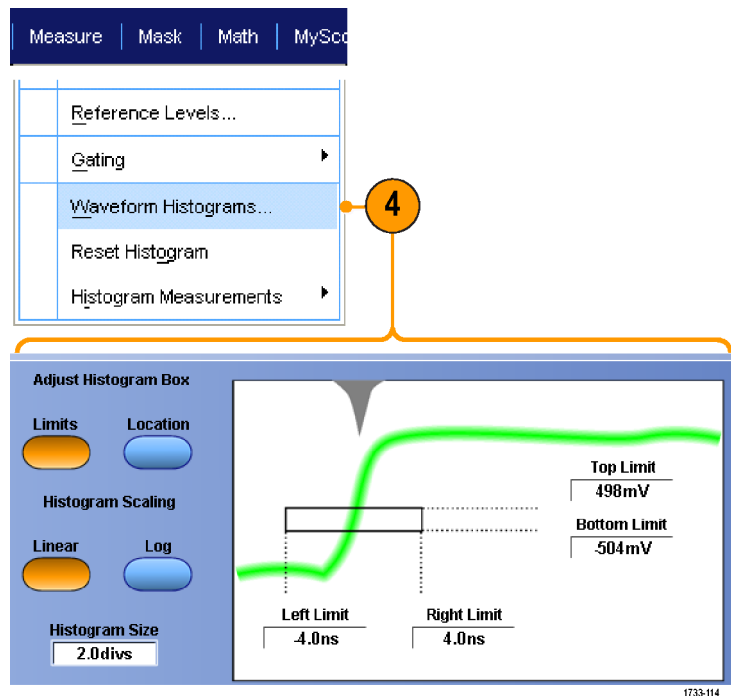

Quick tips

- Use vertical histograms to measure signal noise and horizontal histograms to measure signal jitter.
- Use the click and drag procedure to activate the shortcut menu to turn the histogram display off.

Using math waveforms

Create math waveforms to support the analysis of your channel and reference waveforms. By combining and transforming source waveforms and other data into math waveforms, you can derive the data view that your application requires.

Use the following procedure for predefined math equations.

1. Select **Math > Math Setup....**

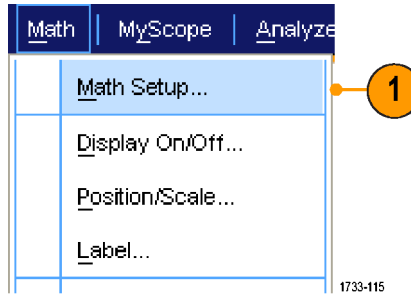

2. Choose one of the predefined math equations.

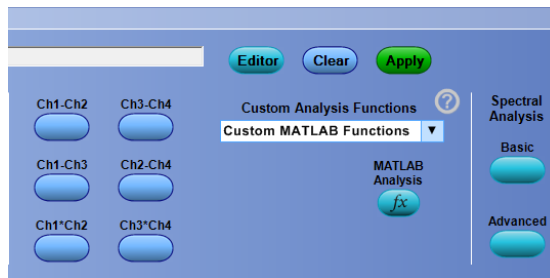

Use the following procedure to build an advanced math waveform expression.

1. Select **Math > Math Setup....**

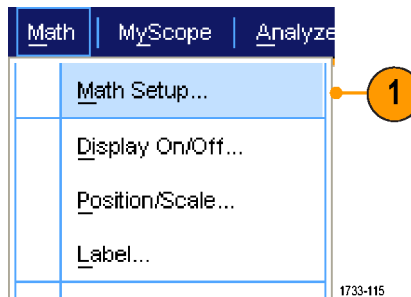

2. Click **Editor**.

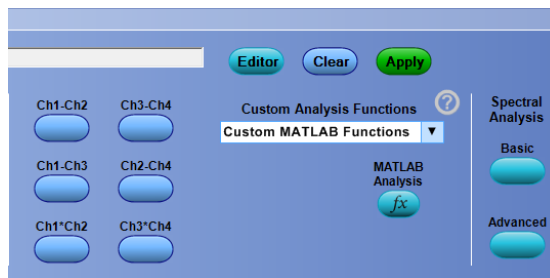

- Build your advanced math waveform expression using sources, operators, constants, measurements, variables, and functions.
- When you have defined the expression to your satisfaction, click **Apply**.

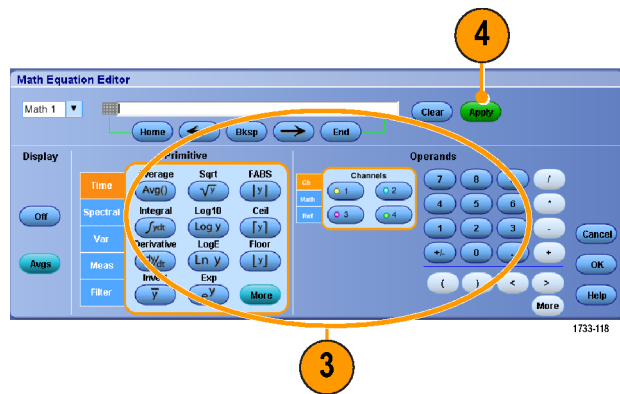

- To add your own filter, click the **Filter** tab. Click **Load**.

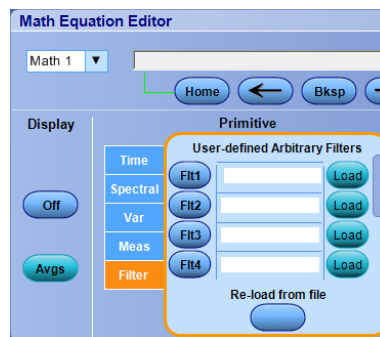

- Double click the folder for the filters you want to use. Double click the filter you want to use.

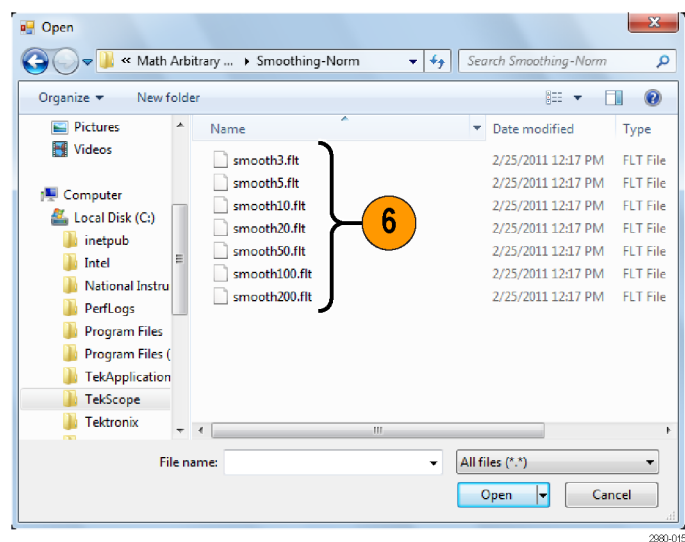

- Build your math expression using the filter you selected.
- When you have defined the expression to your satisfaction, click **Apply**.

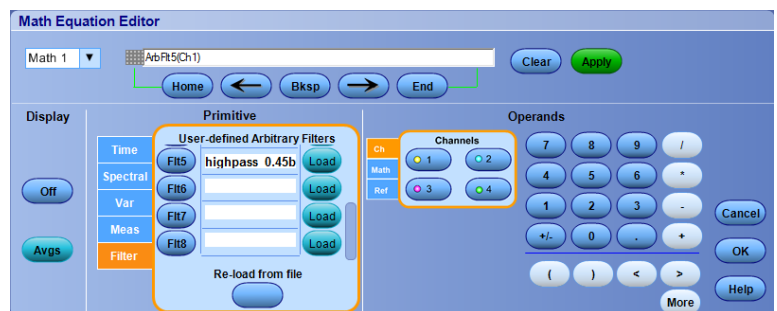

Quick tips

- Double clicking on a math expression opens the Math Equation Editor.
- Math definitions are not implemented if the sources are not valid.
- Math waveforms are created from analog channel, reference, math source waveforms and from measurements.
- Measurements are taken on math waveforms in the same way as on channel waveforms.
- Math waveforms derive their horizontal scale and position from the sources in their math expressions. Adjusting these controls for the source waveforms also adjusts the math waveform.

- If Autoscale is not checked, vertical scale and position are not calculated when a math waveform is turned on or the math equation is changed.
- Magnify math waveforms using MultiView Zoom; use the mouse for positioning the zoomed area.
- See the online help for more information on arbitrary math filters.

Using spectral analysis

Use the following procedure for predefined spectral math expressions. See the online help for more information.

1. Select **Math > Math Setup...**

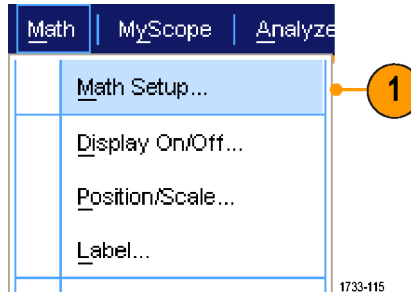

2. Choose one of the predefined spectral math expressions.
3. Click **Basic**.

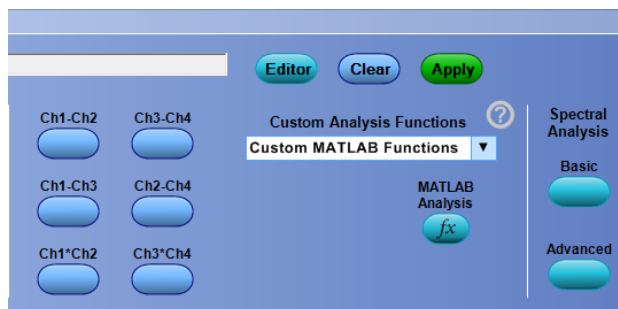

4. Click Resolution BW or Frequency Span and use the keypad or the multipurpose knobs to adjust the spectral display.

NOTE. Resolution BW and Frequency Span are only adjustable in Manual Horizontal Mode.

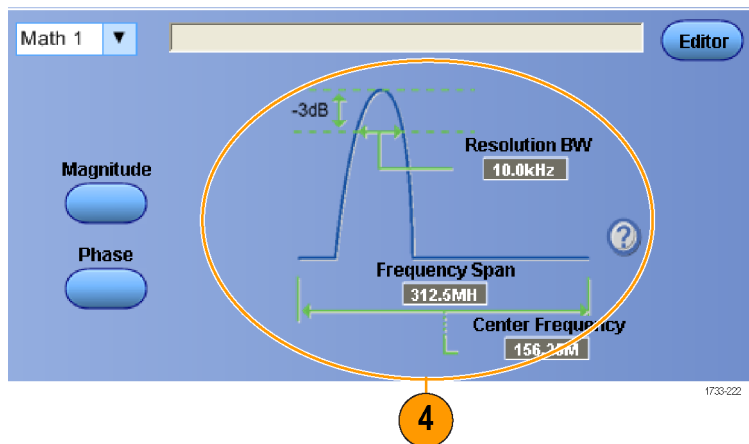

Use the following procedure to build an advanced spectral math expression.

1. Select **Math > Advanced Spectral...**

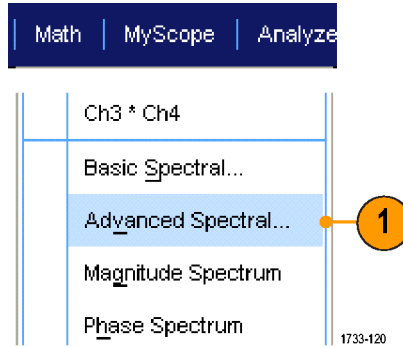

2. Select the math waveform that you want to define.
3. Click the type of spectral waveform that you want to create. To redefine a waveform, click Clear.
4. Select the source waveform.
5. Adjust the spectral waveform, using the controls in the Spectral Setup control window or use the multipurpose knobs on the Auxiliary Front Panel.

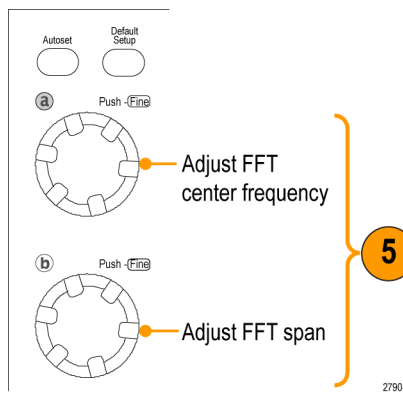
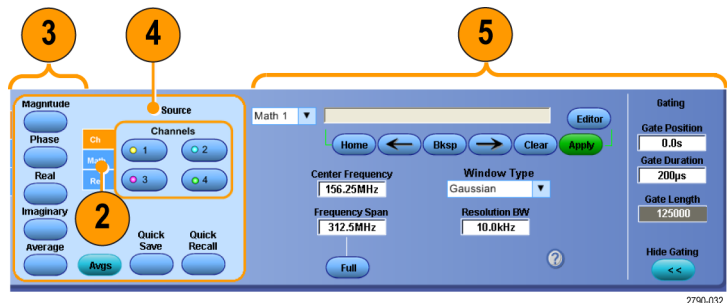

6. View time-domain and frequency-domain waveforms simultaneously.
Use **Gating** to select only a part of the time-domain waveform for spectral analysis. See [Gating](#) on page 126.

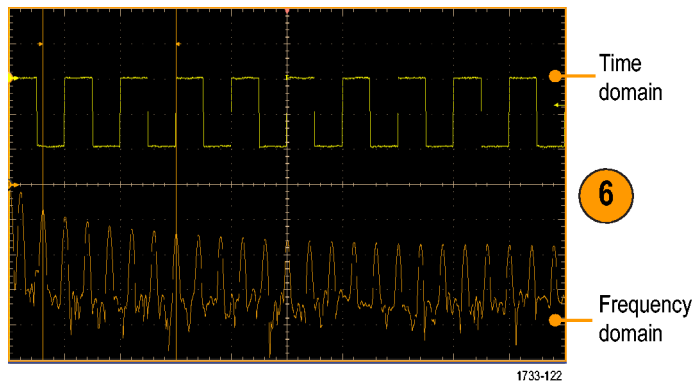

Quick tips

- Sources for spectral math waveforms must be channel or other math waveforms.
- Use short record lengths for faster instrument response.
- Use long record lengths to lower the noise relative to the signal and increase the frequency resolution.

- Different window functions produce different filter response shapes in the spectrum and result in different resolution bandwidths. See the online help for more information.
- The resolution bandwidth (RBW) directly controls the gate width. Therefore, the time domain gate markers move as you adjust the control.
- You can display the linear magnitude of the real data or the imaginary data in the spectrum. This is useful if you process the spectrum off line and transform it back into a time domain trace.

Using mask testing

Serial Communications Mask Testing (Option MTM or MTH) allows you to compare your signal to a predefined template or mask. For the signal to pass the test, it must fall outside the segments defined by the mask. Generally, standards committees such as ANSI define the masks. To perform mask testing do the following:

1. Select **Mask > Source...**

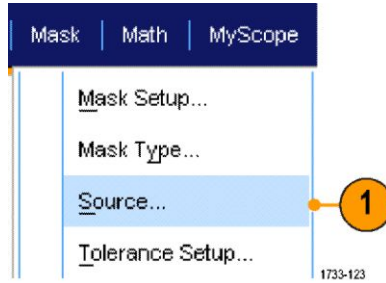

2. Select the signal source.

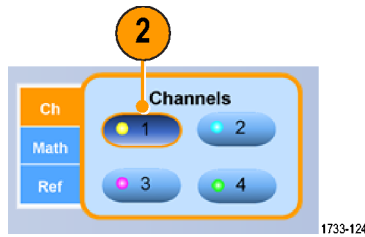

3. Click the **Masks** tab.

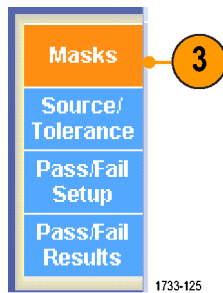

4. Select the Type and standard.

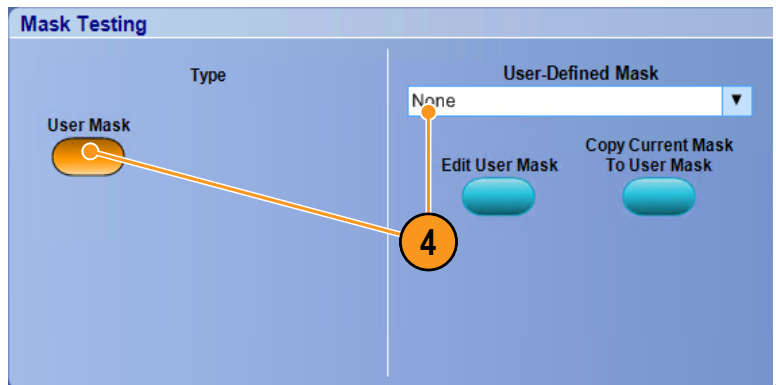

5. Click a **Config** button to access a Mask Configuration control window, where you can adjust how masks and violations are displayed and how Mask Autoset and Autofit are configured.
6. Click **Masks** to return to the Mask Setup control window.

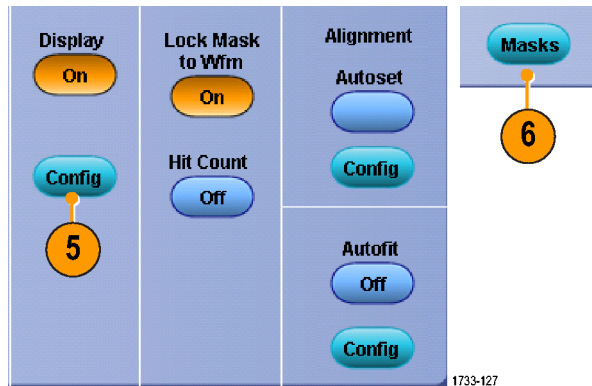

7. Click Lock Mask to Wfm **On** to track mask changes in the horizontal or vertical settings.
8. Toggle Hit Count **On** to highlight violations during a mask test.

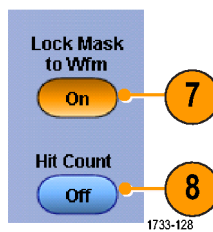

9. Click **Autoset** to automatically align the waveform with the mask based on the characteristics of the input signal.
10. Toggle Autofit **On** to automatically reposition the waveform after each acquisition to minimize hits.

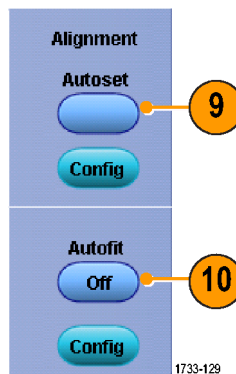

11. Click the **Tolerance** tab, and then set the tolerance.

Tolerance settings greater than 0% make the mask test harder to pass, settings less than 0% make the test easier to pass.

Use 0% if you want the mask as specified in the standard. Changing the percentage allows you to do margin testing.

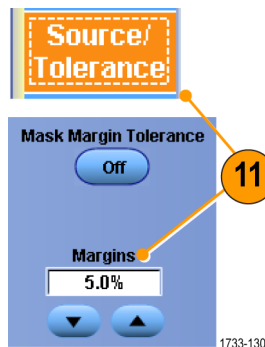

12. Select the **Pass/Fail Setup** tab, and then set up the pass/fail parameters. (When acquisition mode is Waveform Database, the # of Wfms label becomes Samples.)
13. Select your Pass/Fail Test Notifications.

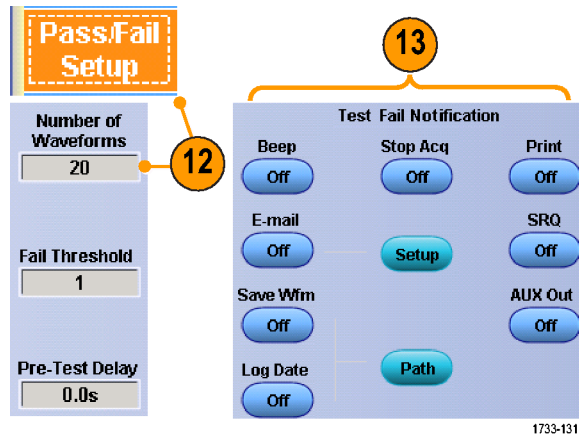

14. Select the polarity of the waveform you want to test.
15. Toggle Repeat **On** to run the mask test continuously.
16. Select the notice you want when the test is complete.

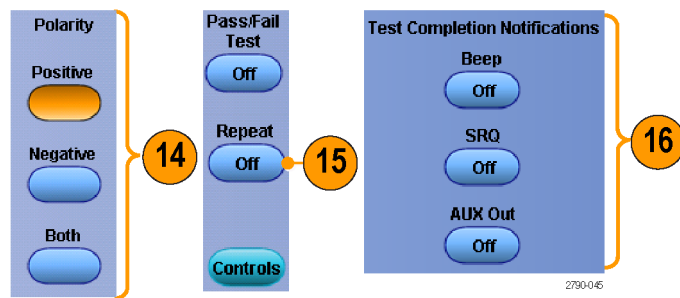

17. Click the **Pass/Fail Results** tab to view the test results.
18. Click Pass/Fail Test **On** to start the mask test.
19. Click **Reset** to reset the totals and clear any violations.

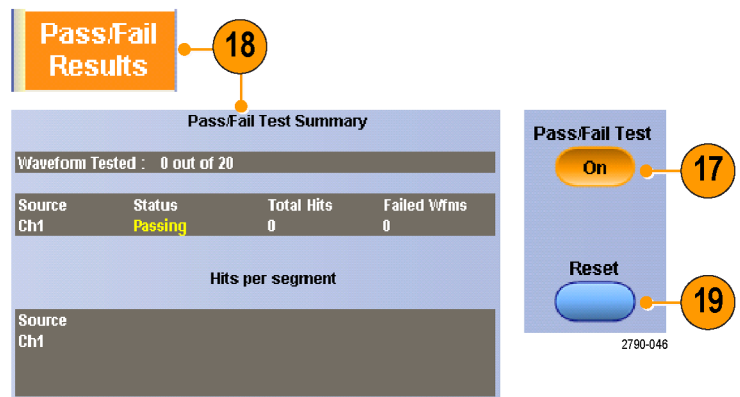

Quick tips

- If the signal is not within the mask, enable Autoset to center the waveform in the mask.

Using limit testing

Optional limit testing allows you to compare an active signal with a template waveform. Build your template waveform from a known good signal and use it to compare to an active signal to perform pass/fail testing.

1. Select **Mask > Limit Test Setup...**

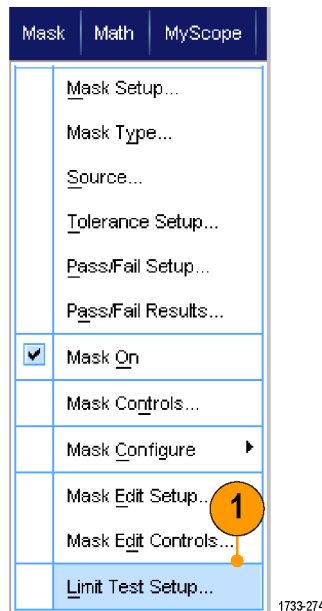

2. Create the template by selecting the Source, Destination, and Tolerances. Use the multipurpose knobs to adjust the Tolerances. Tolerances specify how much margin the signal is allowed before failing the limit test.

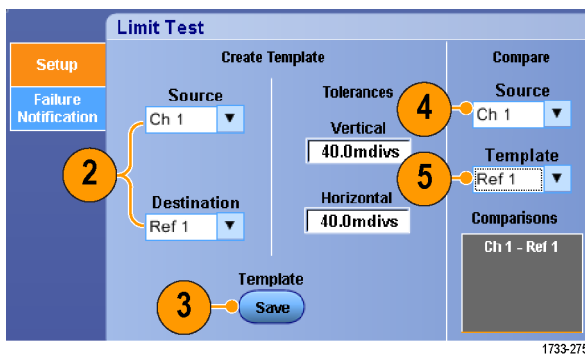

3. Click **Save**. You can create multiple templates and save them for later use.
4. Select the source waveform to compare to the template.
5. Select the template to compare to the Source waveform. (Usually, this is the template that you created in step 3).

6. Click **Failure Notification** to set up the Failure Notification.
7. Select the failure notification(s), and then click **Setup** to return to the setup control window.

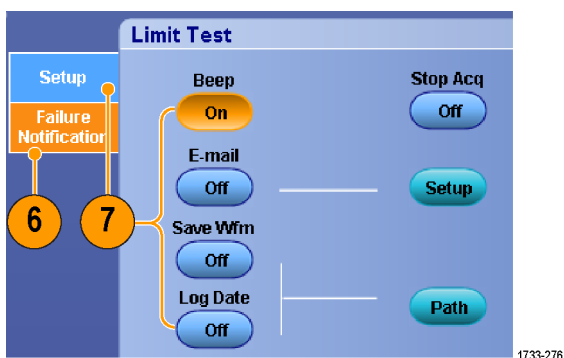

8. Click Lock Template to Waveform **On** to lock the vertical scale or position of the template to that of the source waveform.
9. Click Highlight Hits **On** to show points that fall outside the template in a different color.

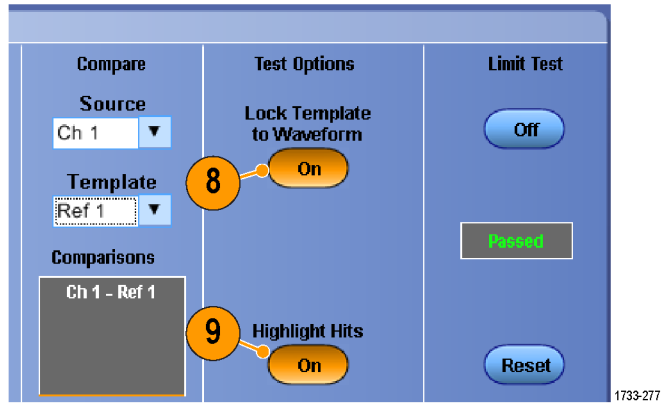

10. Toggle Limit Test to **On** to start the test.
11. Click **Reset** to clear all violations and reset the test.

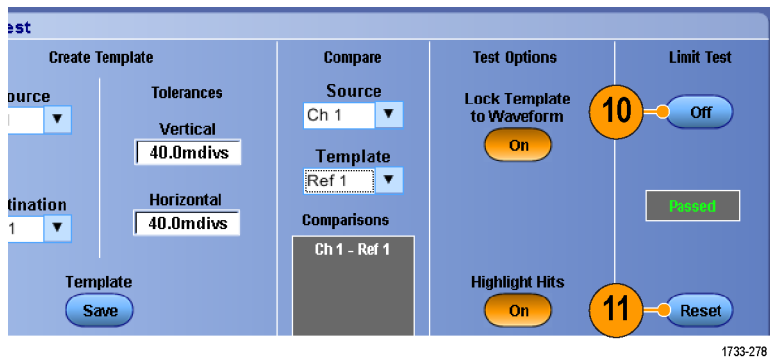

Quick tips

- Use active or saved waveforms to create a limit test template.
- Using Average acquisition mode will create a smoother template waveform.
- Using Envelope acquisition mode will create a template that allows for occasional overshoots.
- Limit testing is not available in multi-unit configurations.

MyScope

MyScope allows you to create custom control windows that include only the controls that you use regularly. Instead of switching between several control windows, put the controls you use into a custom control window.

This section contains procedures for creating and using MyScope control windows. Detailed information is available in the online help.

Creating a new MyScope control window

1. Select **MyScope > New Control Window...**

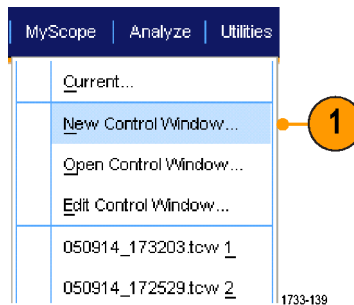

2. Click + to expand a category. Controls that you can add to your MyScope control window are contained within each category. The categories match the menu bar to help you find the controls you normally use.

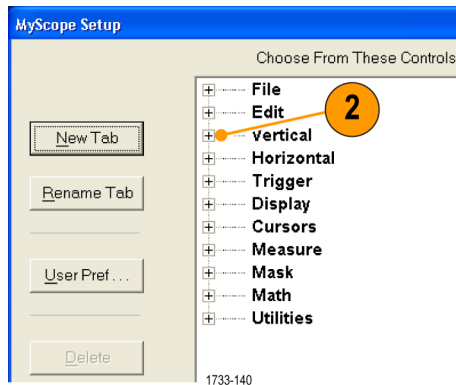

3. Click a control to preview it.

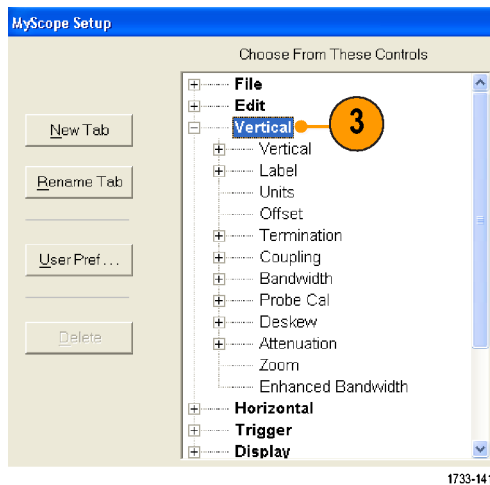

4. Double-click the control or click the + to expand the control list. (If there is no +, then the control cannot be customized further.)

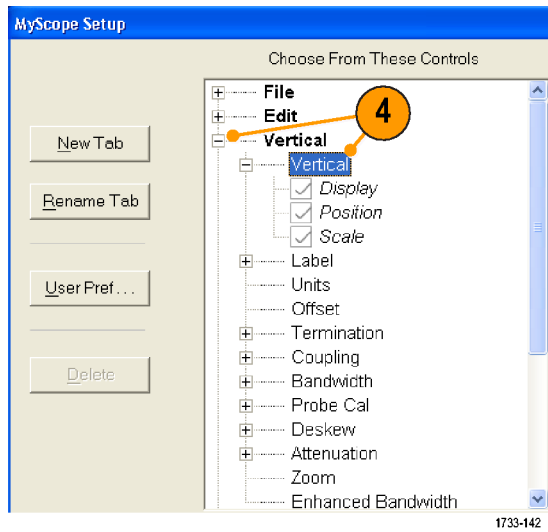

5. Clear the check boxes to remove any components that you do not want included in the control.

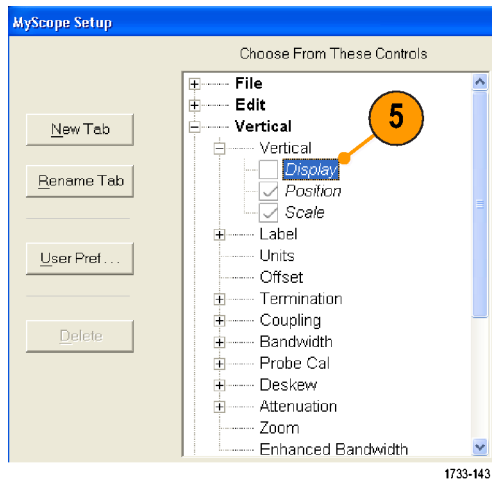

6. Click and drag the control to your MyScope control window. The control will snap to the nearest grid location when you release the mouse. Change the placement of the control in your MyScope control window by clicking and dragging.

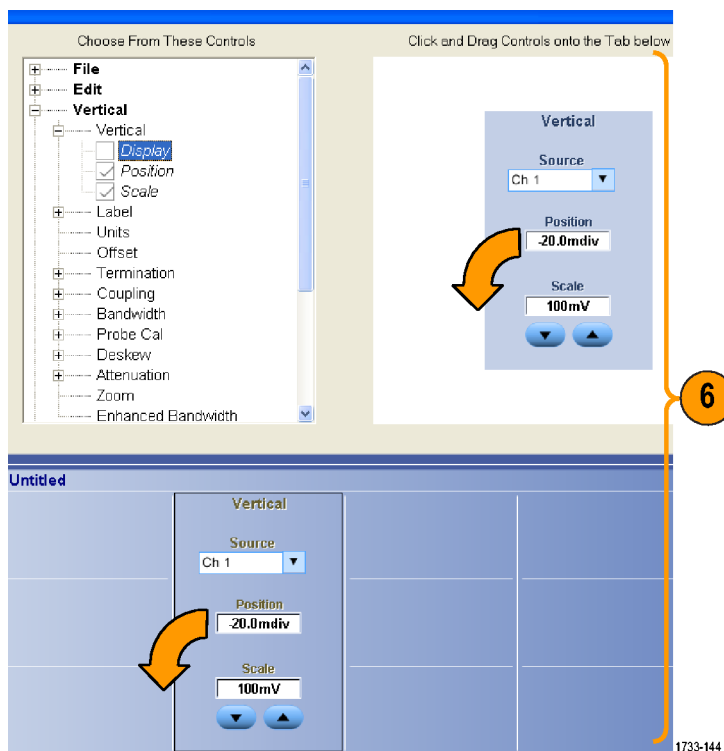

7. Click **New Tab** to add a tab to your MyScope control window. You can have up to six tabs.
8. To rename a tab do one of the following:
- Click **Rename Tab**.
 - Double-click the tab, and then type the new name.

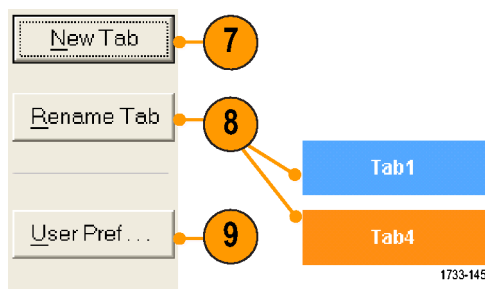

9. Click **User Pref...** to specify user preferences that are loaded with your MyScope control window.
10. To delete controls do one of the following:
- Select a tab, and then click **Delete**. The tab and all of the controls are deleted.
 - Select a control, and then click **Delete**. Just the selected control is deleted.

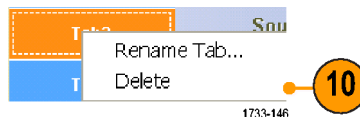

11. Click **Save**, and then enter a name for your MyScope control window, or use the default name.

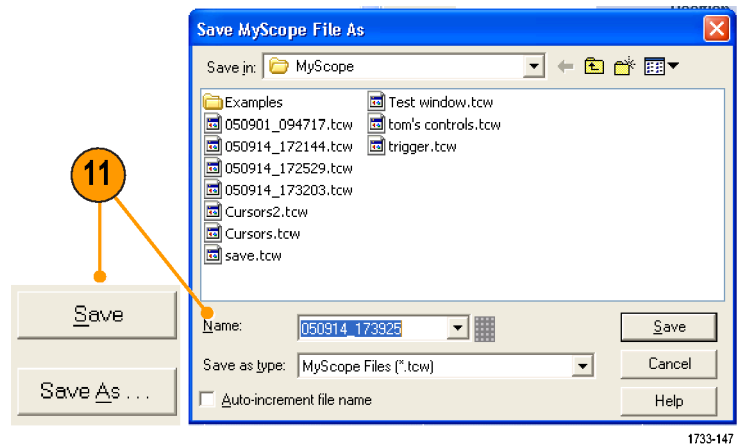

1733-147

Quick tips

- To reconfigure a control, click and drag it back to the preview window. Then select or clear the check boxes to include or remove components in the control.
- To change the tab order, click and drag a tab to a new location.
- To delete a control, click and drag it to the upper half of the screen (out of your MyScope control window).

Using MyScope control windows

To open a previously defined MyScope control window, do the following:

1. Select **MyScope > Open Control Window...** or one of the five most recently used MyScope windows.

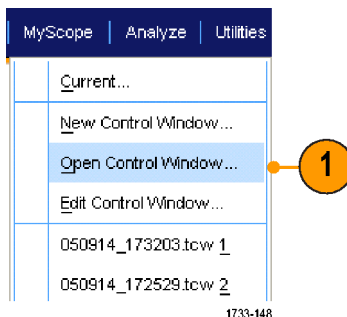

2. Select the MyScope control window you want to use, and then click **Open**.

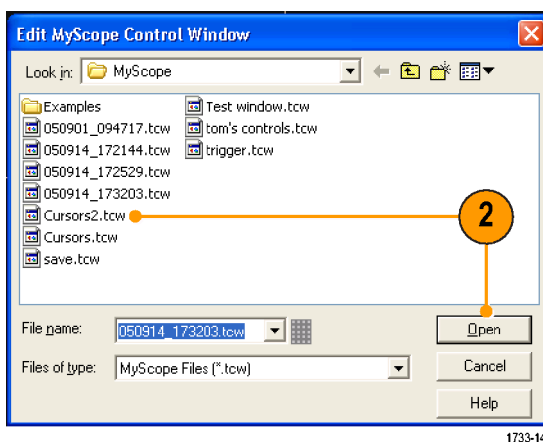

To display the active MyScope control window, do the following:

1. Select **MyScope > Current...** or click **MyScope** in the toolbar mode. (Your MyScope control window remains active even when it is not displayed.)

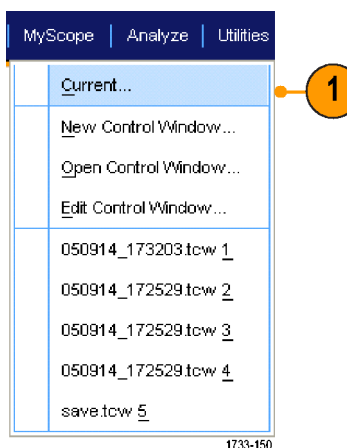

To edit a MyScope control window do the following:

1. Select **MyScope > Edit Control Window....**

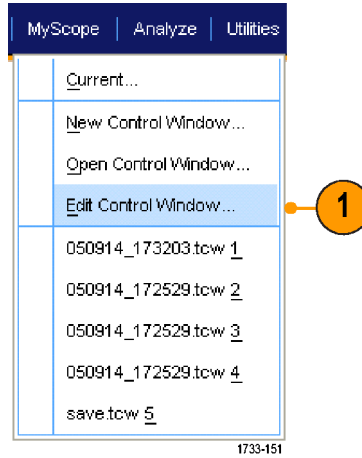

2. Select the control window you want to edit, and then click **Open**.

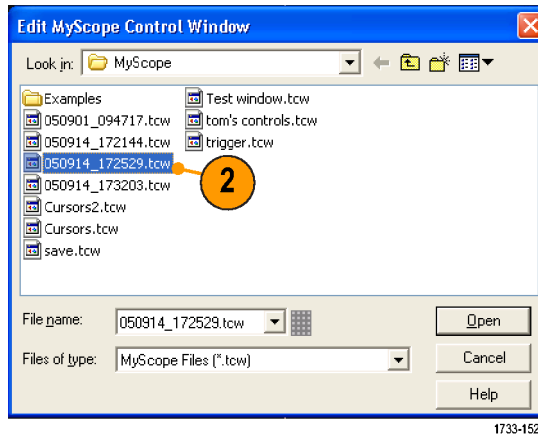

Quick tips

- Some controls function differently in a MyScope control window than they do in the standard control window. For details, see the online help.
- You can copy MyScope control windows (.tcw files) to other MSO/DPO7000DX, MSO/DPO7000C, DPO7000C, and MSO/DPO5000B Series instruments.

Saving and recalling information

This section contains procedures for saving and recalling screen captures and setups, saving measurements, using the clipboard, and printing on your instrument. Detailed information is available in the online help.

Saving screen captures

1. Select **File > Save** or **Save As > Screen Capture...**

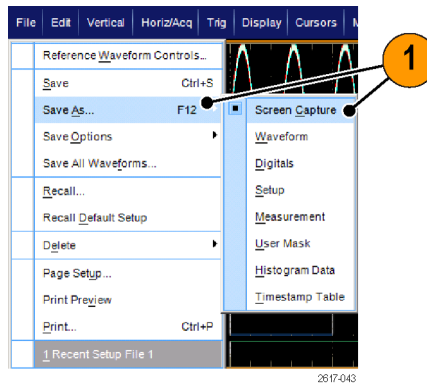

2. Click **Options...** to set up the Palette, View, Image, or Screen Capture Format options; otherwise, skip to step 3.

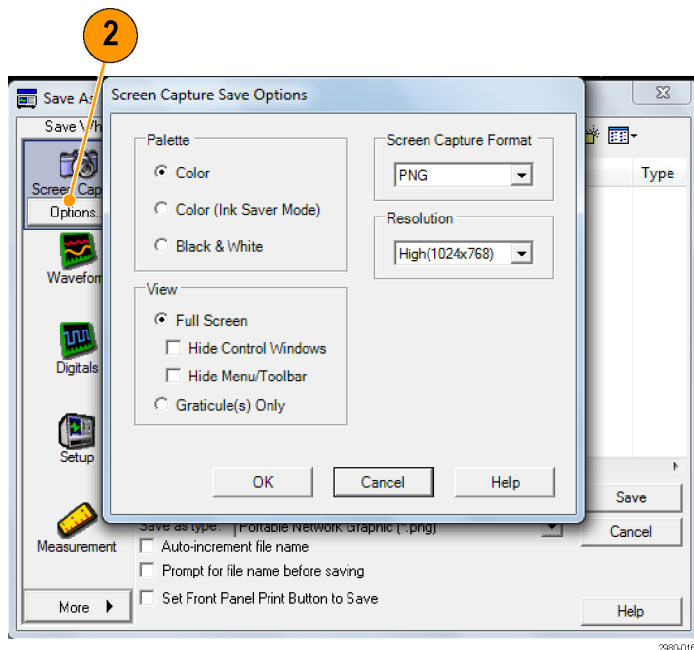

3. Select the location to save the screen capture.
4. Type in a name for the screen capture, or use the default name, and then select a file type.
5. Click **Save**.

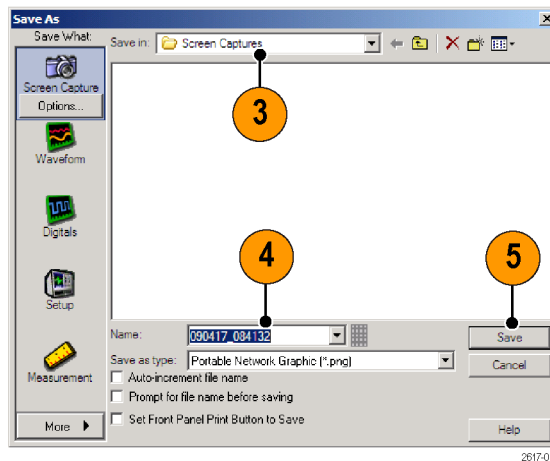

Quick tip

- To quickly save multiple screen captures, select **Set Front Panel Print Button to Save**, and then click Save. You can now save a screen capture by pushing the Print button on the Auxiliary Front Panel.

Saving waveforms

1. To save waveforms, select **File > Save** or **Save As > Waveform....**

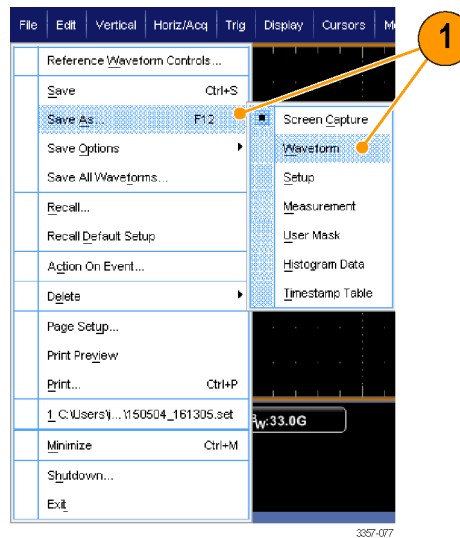

2. Click **Waveform**.
3. Click **Options...** to specify the Waveform Data Range, FastFrame Data Range, Waveform Detail, Data Destination, Source, or Data Ordering; otherwise, skip to step 4.

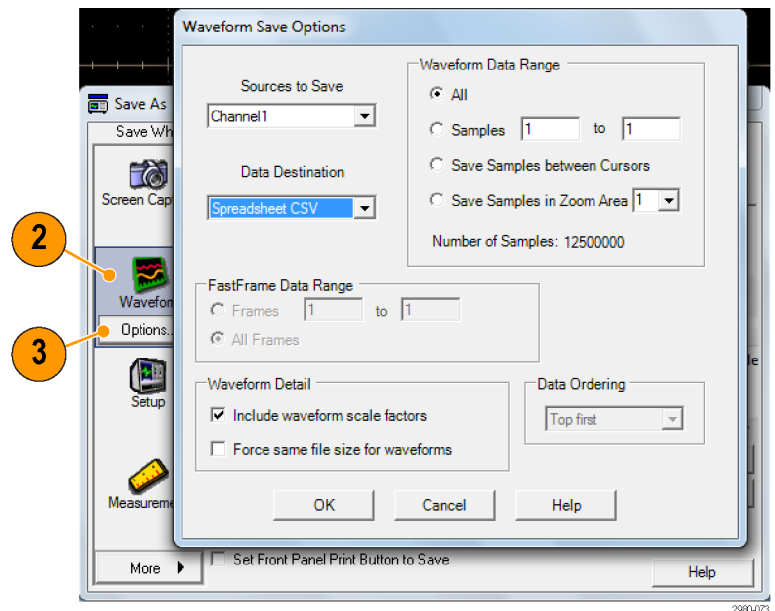

4. Select the Source.
5. You can either save the waveform as a reference waveform in the instrument memory or as a .wfm file in a Windows directory. To save the waveform as a reference, select Ref 1–4. To save as a .wfm file, select the location where you want to save the waveform.
6. If you are saving as a .wfm file, type in a file name, or use the default.
7. Click **Save**.

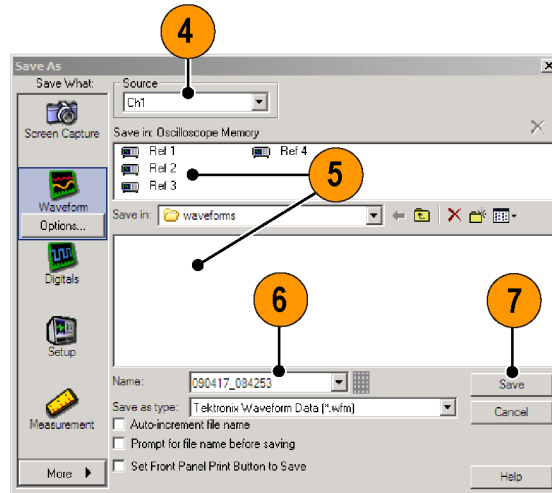

Quick tips

- Select **Auto-increment file name** to save similar waveforms without having to retype the entire name.
- To quickly save multiple waveforms, select **Set Front Panel Print Button to Save**, and then click Save. You can now save a waveform by pushing the Print button on the Auxiliary Front Panel.

Recalling waveforms

1. Select **File > Recall...**

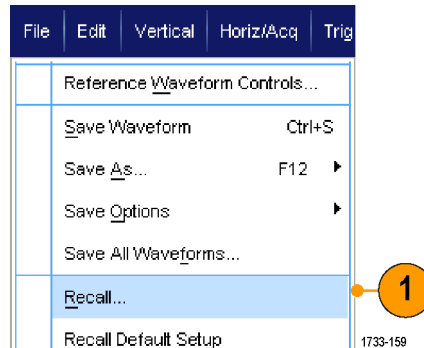

2. Click **Waveform**.
3. Select the Destination of the waveform you are recalling.
4. Select the waveform to recall.
5. Click **Recall**. Clicking Recall turns on the reference waveform and activates the Reference Waveform control window.

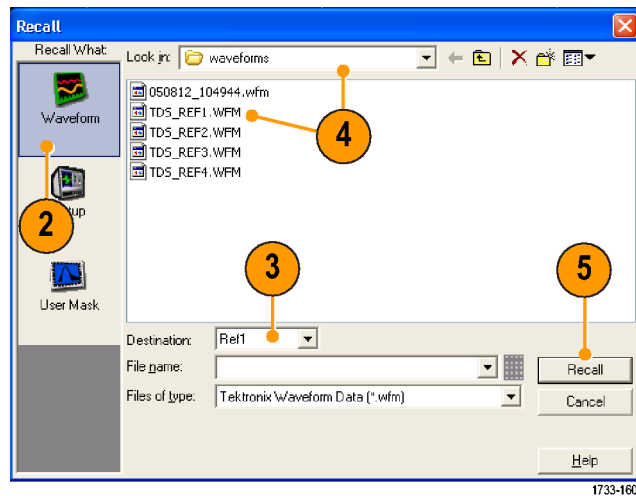

6. Use the controls to adjust the Reference waveform. You can also access the Reference Waveform control window by selecting **File > Reference Waveform Controls....**

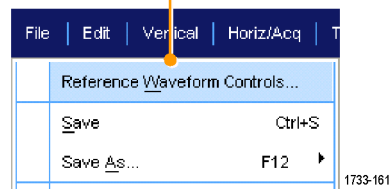
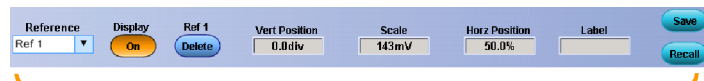

Quick tip

- You can save several different file types but you can only recall setup (*.set) files and waveform (*.wfm) files.

Saving instrument setups

1. Select **File > Save** or **Save As > Setup...**

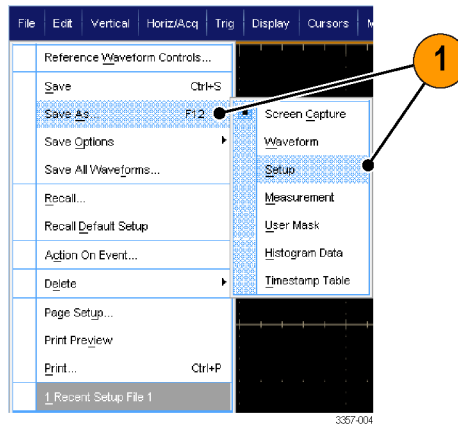

2. Click **Setup**.
3. Select the location where you want to save the setup. Either save the setup to the instrument memory in one of the ten setup storage locations or as a .set file in a Windows directory.
4. Type a file name or use the default name. Use the pop-up keyboard to type a file name for a setup saved to the instrument memory.
5. Click **Save**.

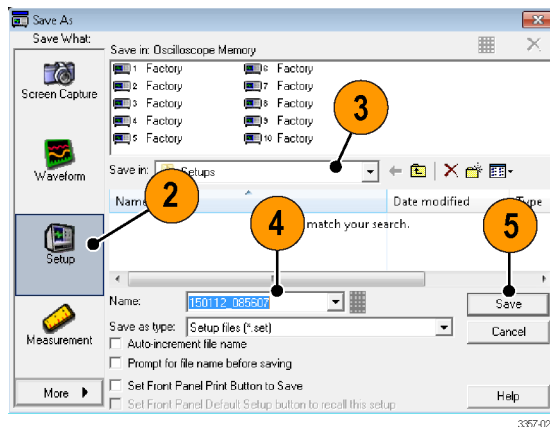

Quick tips

- If the touch screen is enabled, use the pop-up keypad to label the setups for easy identification.
- Use Auto-increment file name to save similar files without having to retype the entire file name.
- To quickly save multiple setups, select **Set Front Panel Print Button to Save**, and then click Save. You can now save a setup by pushing the Print button on the Auxiliary Front Panel.

Recalling instrument setups

1. Select **File > Recall...**

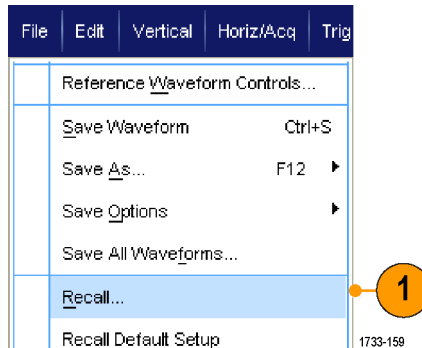

2. Click **Setup**.
3. Select the setup you want to recall. Recall a setup file from one of the ten locations in the instrument memory or from a Windows directory.

To retain your current deskew settings, click **Don't recall deskew values**.

4. Click **Recall**.

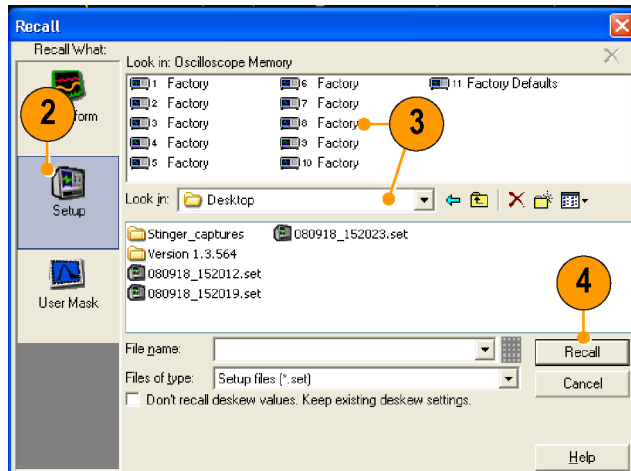

1733-164

Quick tip

- You can recall any setup stored on disk and then save it in an internal setup storage location for quicker access.

Saving measurements

1. Select **File > Save** or **Save As > Measurement...**

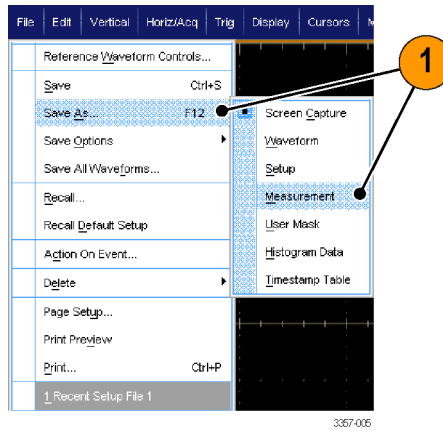

2. Click **Options...** to specify Displayed Measurements, Measurement Snapshot, or Measurement Format; otherwise, skip to step 3.

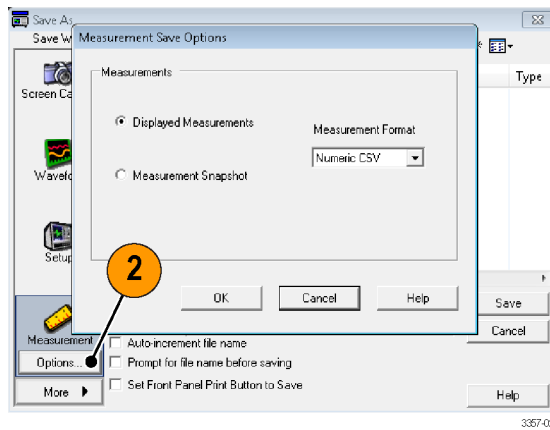

3. Select the location to save the measurement.
4. Type in a name for the measurement, and then select a file type.
5. Click **Save**.

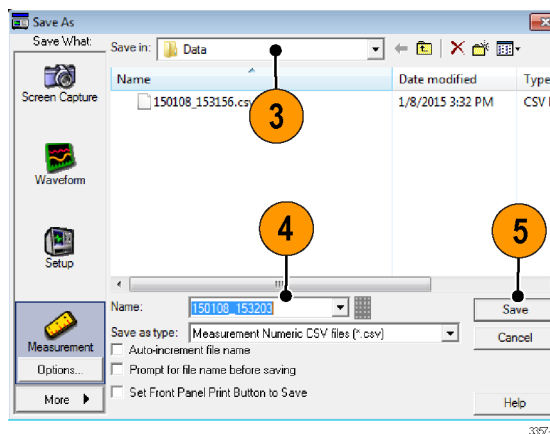

Saving user masks

1. Select **File > Save** or **Save As > User Mask**.

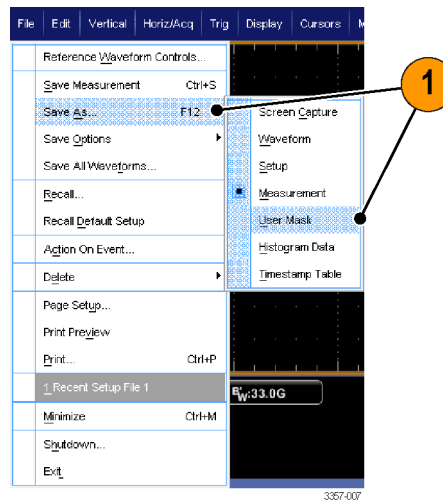

2. Click **User Mask**.
3. Select the location to save the mask.
4. Type in a name for the mask, and then select a file type.
5. Click **Save**.

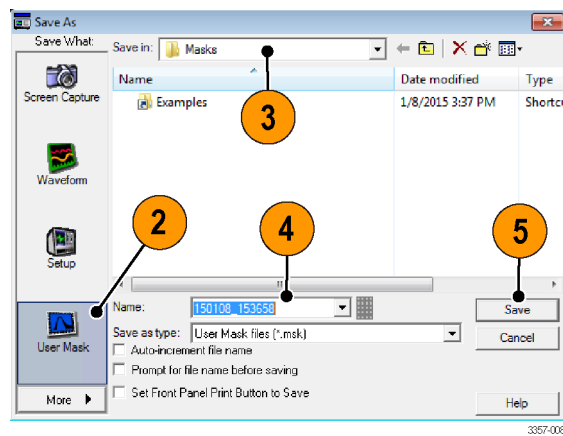

Saving histogram data

1. Select **File > Save** or **Save As > Histogram Data**.

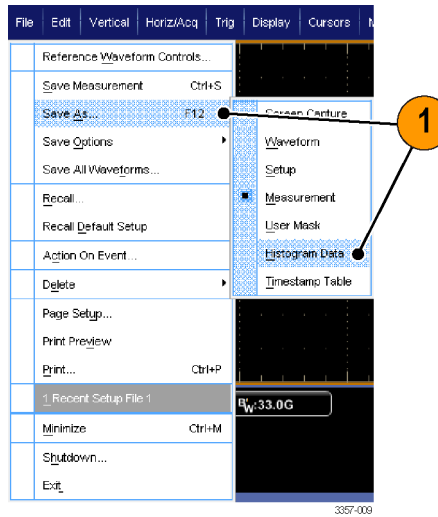

2. Select **Histogram**. Depending on previous selections, you may need to select **More > Histogram Data** to display the Histogram selection.
3. Select the location to save the histogram.
4. Type in a name for the histogram, and then select a file type.
5. Click **Save**.

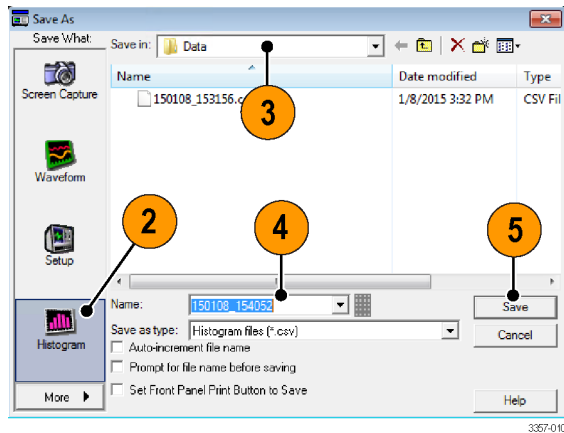

Saving timestamps

1. Select **File > Save or Save As > Timestamp Table**.

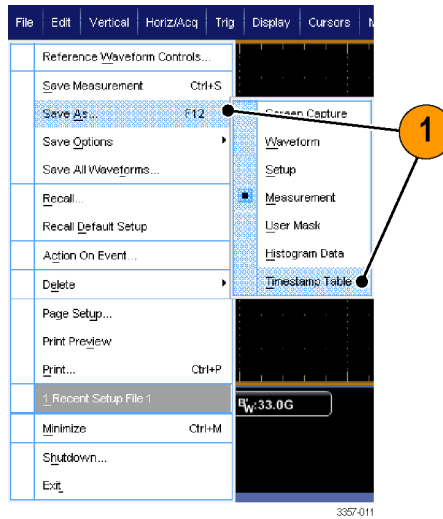

2. Click **Timestamp**. Depending on previous selections, you may need to select **More > Timestamp Table** to display the Timestamp selection.
3. Click **Options...** to specify the Source or FastFrame Data Range; otherwise, skip to step 4.

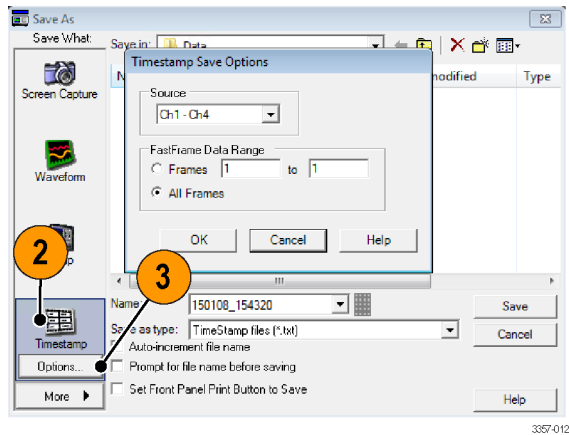

4. Select the location to save the timestamp.
5. Type in a name for the timestamp, and then select a file type.
6. Click **Save**.

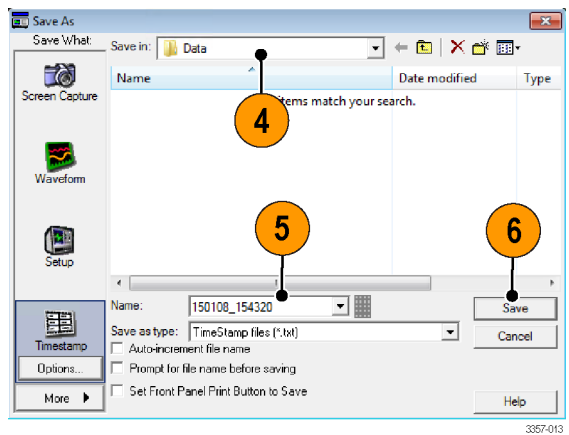

Copying your results to the clipboard

Use the following procedure to set the output content and format for images, waveforms, or measurements to be copied to the Microsoft clipboard.

1. Select **Edit > Copy Setup...**

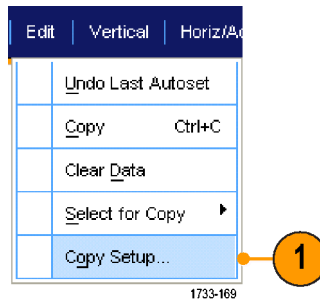

2. Click the **Images**, **Waveforms**, or **Measurements** tab, and then select the desired options.

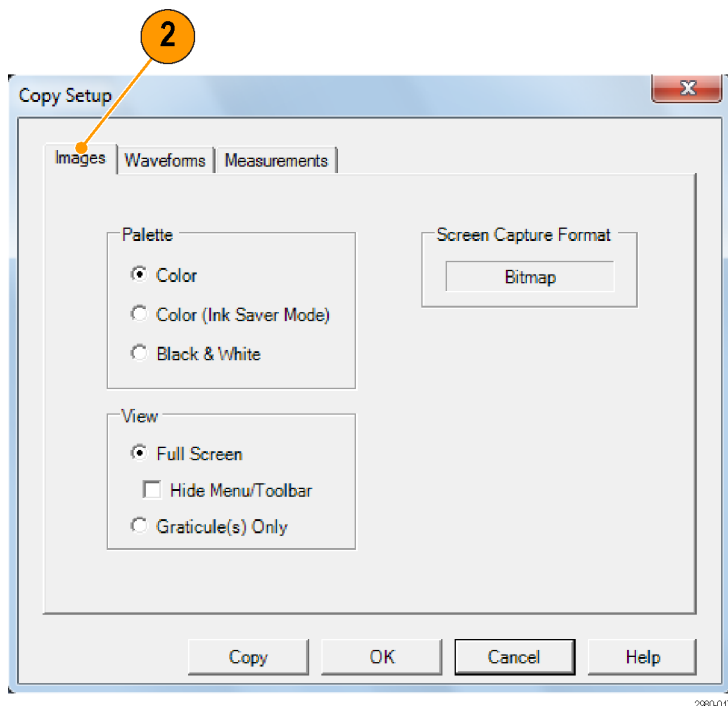

To copy images, waveforms, or measurements, use the following procedure:

1. Select the item that you want to copy.
2. Select **Edit > Copy** or press **Ctrl + C**.
3. Press **Ctrl + V** to paste the item into a Windows application.

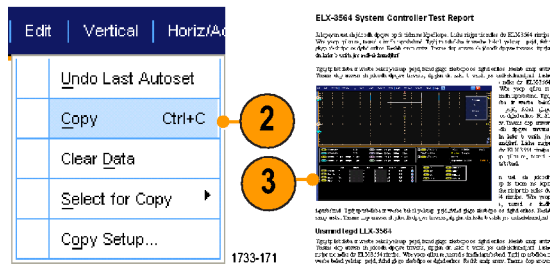
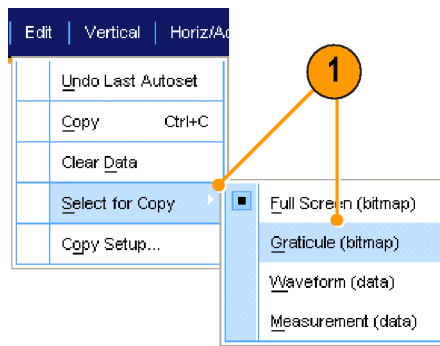

Printing a hard copy

1. To print a hard copy, push the print button or select **File > Print**. If necessary, make changes to the page orientation in the Page Setup dialog box.

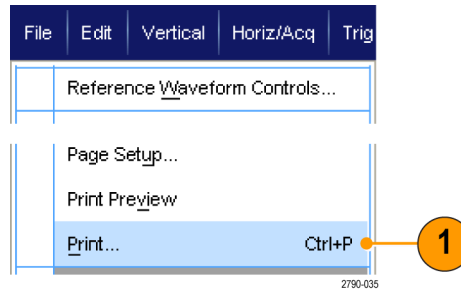

Your Print and Page Setup dialog boxes will depend on the printer you are using.

2. Click **Page Setup...**

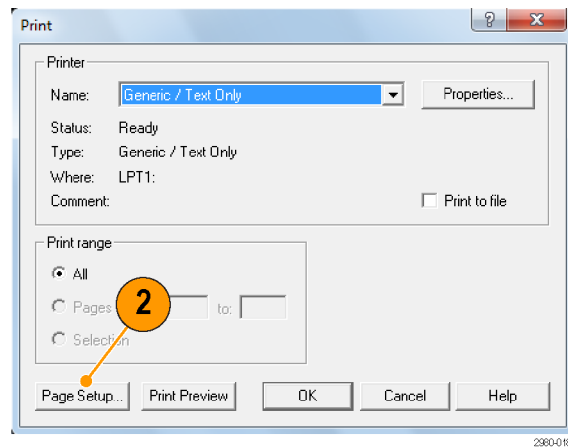

3. Select the printing parameters.

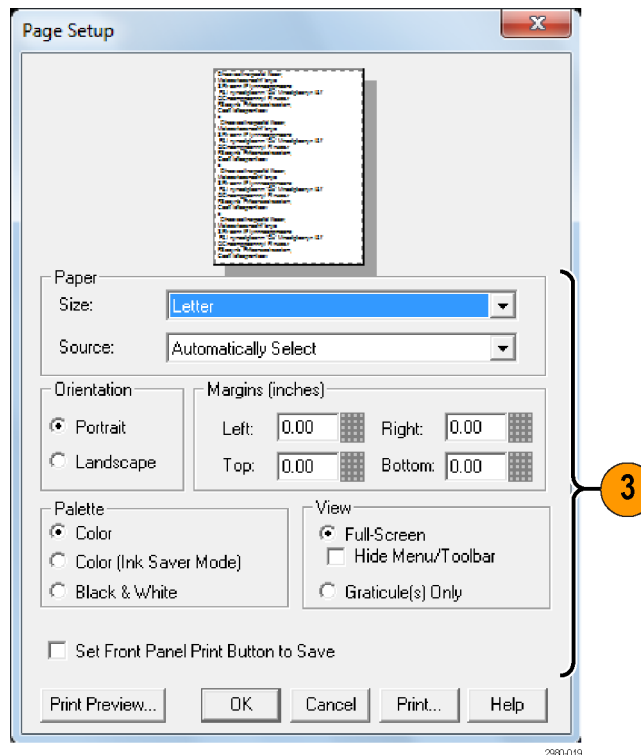

Run application software

Each application is available for ten free trials on your instrument. These applications provide application-specific measurement solutions. Some examples are described below. Additional packages may be available. Some applications may not be available on your instrument. Contact your Tektronix representative or visit our Web site at www.tektronix.com for more information.

- Use **DJA** DPOJET Jitter and Eye Diagram Analysis, Advanced to reliably measure complex clock, digital, and serial data signals. DPOJET Essentials included standard with all models.
- Use DJAN-DPOJET to reliably measure complex clock, digital, and serial data signals (requires option DJA).
- Use **LT** Waveform Limit Testing to compare an acquired waveform to tolerance boundaries that you set.
- Use **MOST** Essentials for electrical compliance and debug testing for MOST50 and MOST150.
- Use PAM4 to enable transmitter and channel testing for four-level Pulse Amplitude Modulation (PAM4) devices and interfaces.
- Use **SDLA64** Serial Data Link Analysis Visualizer to emulate the serial data channel, de-embed a fixture, and add or remove transmitter equalization.
- Use **SR-810B** to enable serial triggering and analysis of 8B/10B signals, requires ST6G.
- Use **SVA** AM/FM/PM Audio Signal Analysis (Requires Opt. SVE) to analyze audio signals.
- Use **SVP**, **SVM**, and **SVE** Spectral Analysis application to validate wideband designs and characterize wideband spectral events.
- Use **SVO** for flexible OFDM analysis, requires SVE.
- Use **SVT** for settling time measurements (frequency and phase), requires SVE.
- Use **SV23** WLAN802.11a/b/g/j/p measurement application (requires Opt. SVE) to measure WLN802.11a/b/g/j/p signals.
- Use **SV24** WLAN 802.11n measurement application (requires Opt SV23) to measure WLN802.11n signals.
- Use **SV25** WLAN 802.11ac measurement application (requires Opt SV24) to measure WLN802.11ac signals.
- Use **SV27** SignalVu Bluetooth Basic LE TX SIG measurements to measure Bluetooth signals
- Use **SV28** SignalVu LTE Downlink RF measurements (requires Opt. SVE) to measure LTE Downlink RF signals
- Use **VET** to enable visual trigger and search.

Follow the instructions provided with the application software to install it. To run the software, select **Analyze** and then select the application.

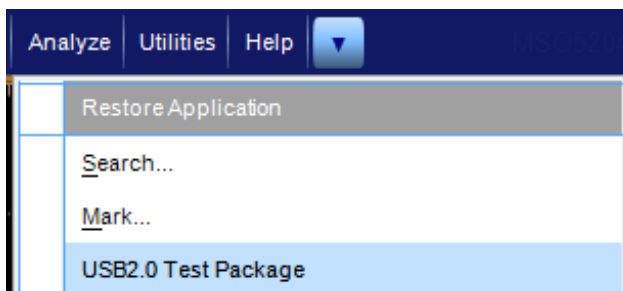

Application examples

This section contains examples of using your instrument in common troubleshooting tasks and extending the use of your instrument.

Capturing intermittent anomalies

One of the most difficult tasks that design engineers face is tracking down the cause of intermittent failures. If you know what type of anomaly you are looking for, it is easy to configure the oscilloscope advanced triggering capability to isolate it. However, when you do not know what you are looking for, it can be exceptionally tedious and time consuming to find infrequent anomalies, especially given the low waveform capture rate on traditional digital storage oscilloscopes.

Digital Phosphor Oscilloscopes enabled by DPX technology have an exceptionally fast acquisition mode called FastAcq, which allows you to find anomalies like these in a matter of seconds or minutes. A regular DSO would take hours or days to find the same event. FastAcq is available on TekConnect channels, but not ATI channels.

Use the following procedure to capture intermittent anomalies.

1. Connect the probe to the input signal source.

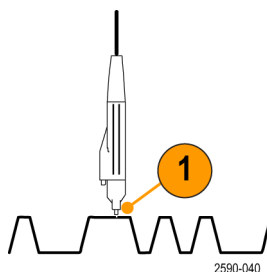

2. Select **Horiz/Acq > Autoset** or push **Autoset** on the Auxiliary Front Panel.

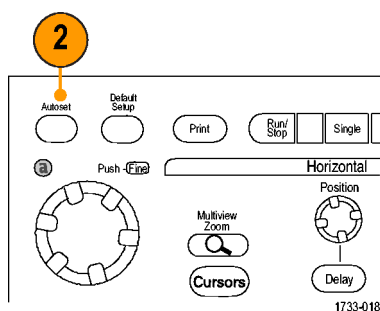

3. Select **Display > Display Persistence > Infinite Persistence**. In this example, you are looking at a clock signal. After observing the signal for 1–2 minutes, but before you look for the problem elsewhere, go to step 4.

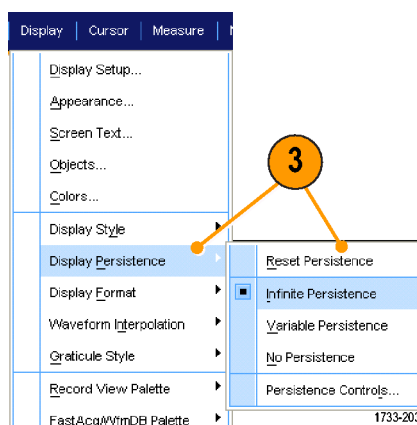

4. Select **Horiz/Acq > Fast Acquisitions**, or push **FastAcq** on the Auxiliary Front Panel.

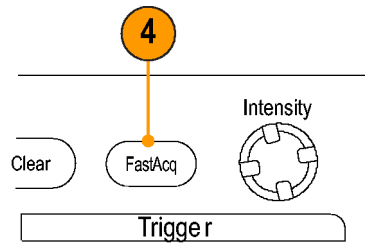

1733-217

5. Find glitches, transients, or other random anomalies that are present in the signal. In this example, FastAcq revealed an ≈ 300 ns positive glitch after only a few seconds.

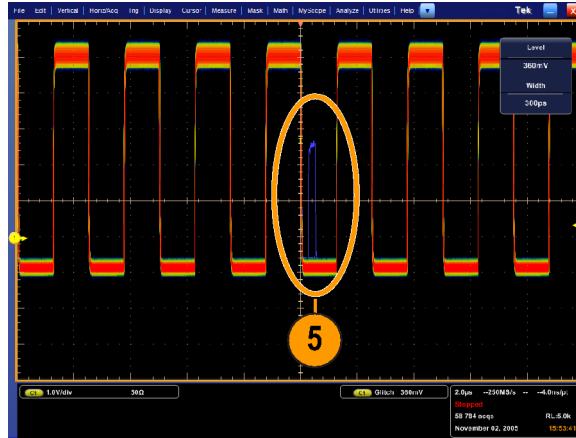

1733-204

6. To trigger on the glitch that you identified in step 5, select **Glitch Setup...**
7. Select the appropriate polarity.
8. Click **Level**, and then set the level based on what you found in step 5.
9. Click **Width**, and then set the width based on what you found in step 5.

Check Envelope if you want the trigger system to treat a high frequency burst as a single pulse.

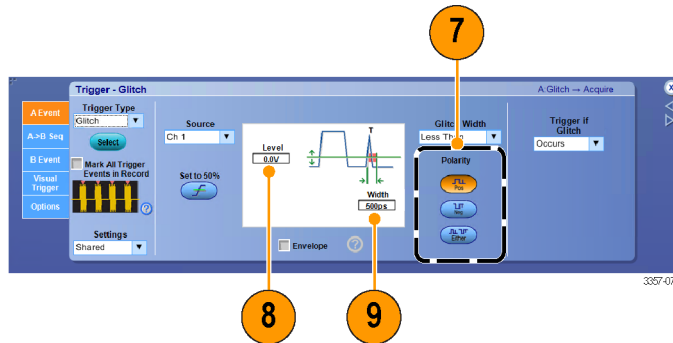

3357-076

10. Click E-mail on Trigger **On**. See [Setting up E-Mail on event](#) on page 93.

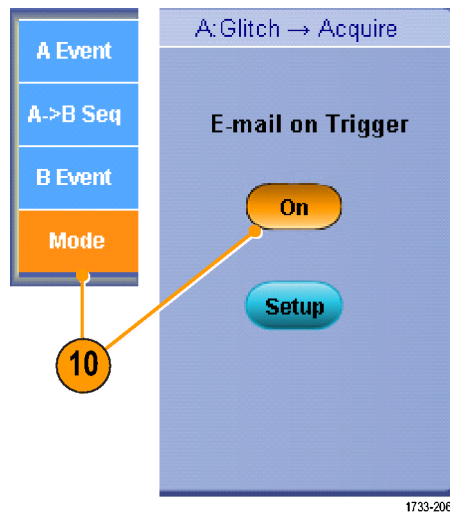

11. To trigger on a single glitch, select **Horiz/ Acq > Run/Stop...** and then click **Single Sequence**, or push **Single** on the Auxiliary Front Panel.

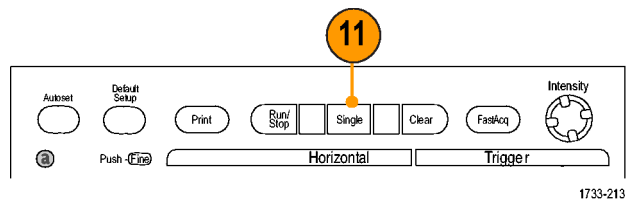

Using the extended desktop and OpenChoice architecture for efficient documentation

Engineers often need to document their lab work for future reference. Instead of saving screen shots and waveform data to a CD or USB memory device, and then generating a report later, try using the OpenChoice architecture to document your work in real time.

To make your instrument the center of your design and documentation process, use the following procedure.

NOTE. On 64-bit systems, you will need 64-bit compatible device drivers and application software.

1. Load Microsoft Word or Excel on your instrument.
2. Connect a second monitor. See [Adding a second monitor](#) on page 30.

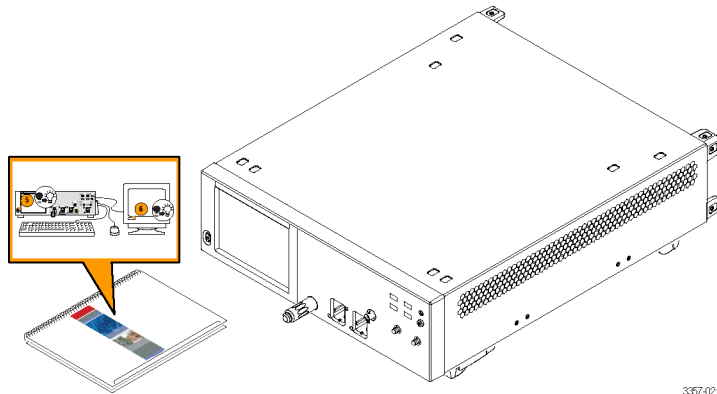

3. Open Microsoft Word, and then drag the Word window onto the extended desktop.

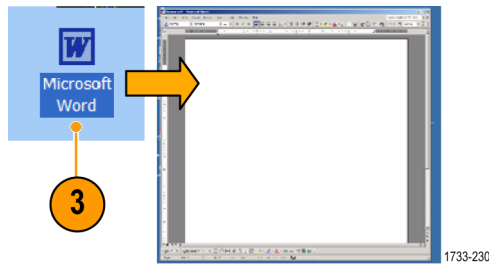

4. Click **TekScope** to restore the instrument application.

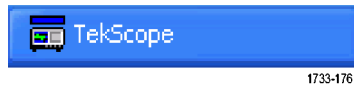

5. Select **Edit > Select for Copy > Full Screen (bitmap)**.

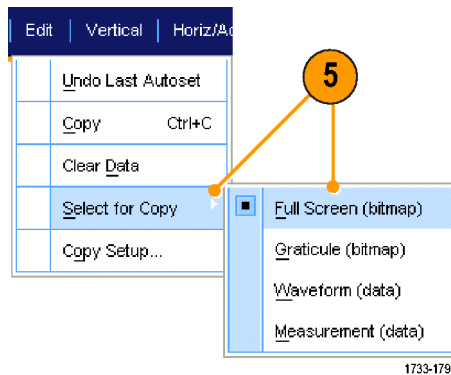

6. Press **Ctrl+C**.
7. Click in the Word document wherever you want to place the screen shot, and then press **Ctrl+V**.

Quick tips

- The instrument comes with a variety of OpenChoice software tools designed for maximum efficiency and connectivity to the rest of your design environment.

Triggering on buses

You can use your instrument to trigger on I²C, SPI, RS-232/422/485/UART, MIPI DSI-1, MIPI CSI-2, 8B/10B, USB, CAN, and parallel buses. The instrument can display both physical layer (as analog waveforms) and protocol level information (as digital and symbolic waveforms).

NOTE. Some trigger types are not available on some instruments.

For detailed bus triggering procedures, use the following procedures: See [Triggering on a parallel bus](#) on page 85. and See [Triggering on a serial bus](#) on page 87.

To set up the bus trigger:

1. Select **Vertical > Bus Setup**.

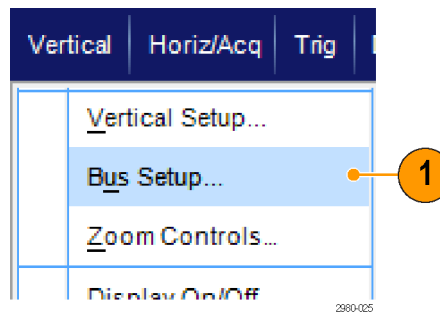

2. Select a bus type.
3. If you selected the **Serial** Bus Type, select the type of serial bus.
4. Specify the components.

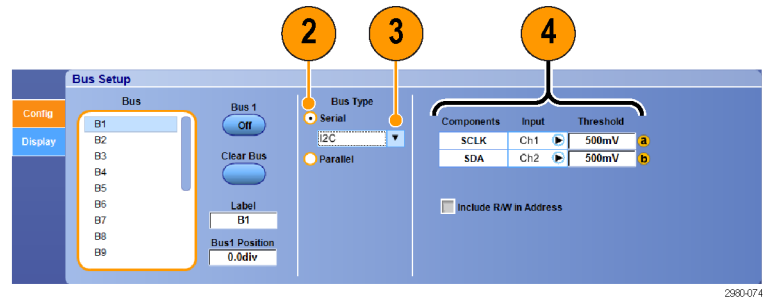

5. Select **Trig > Bus Setup**.

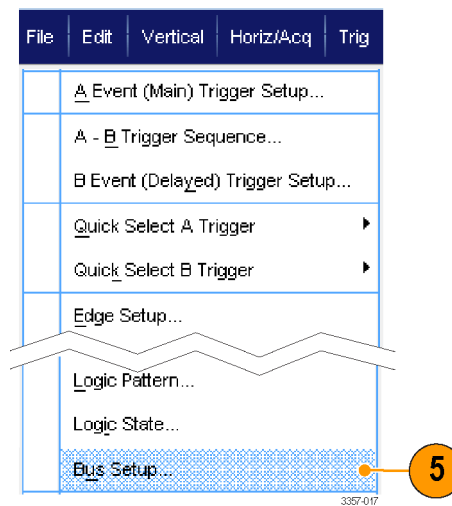

6. Select the bus you set up.
7. Select **Trigger On** to select the desired trigger on feature.

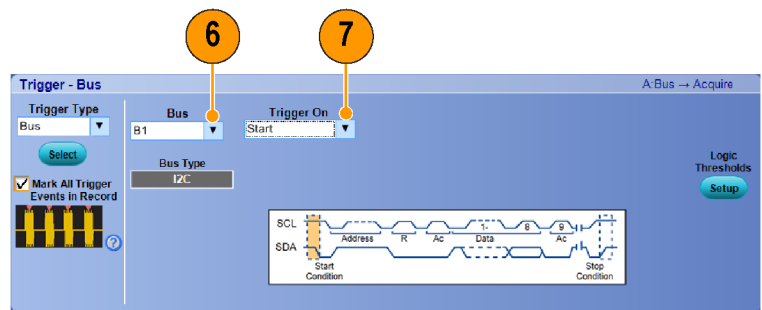

8. Depending on your **Trigger On** selection, you may need to make additional selections.

Appendix A, Maintenance

Maintenance

This section contains information needed to perform periodic maintenance on the instrument.



CAUTION. Do not remove the can that covers the instrument. Removing the can will damage the instrument. A damaged instrument will not meet EMC requirements.

Do not remove the can that covers the instrument. If the instrument requires service, it must be returned to Tektronix.

Cleaning

Use these procedures to clean your instrument. If additional cleaning is required, have your instrument serviced by qualified service personnel.

Exterior cleaning

Clean the exterior surfaces of the chassis with a dry lint-free cloth or a soft bristle brush. If any dirt remains, use a cloth or swab dipped in a 75% isopropyl alcohol solution. Use a swab to clean narrow spaces around controls and connectors. Do not use abrasive compounds on any part of the chassis.

Clean the On/Standby switch using a dampened cleaning towel. Do not spray or wet the switch directly.



CAUTION. Improper cleaning agents, methods, or excessive force can damage the instrument. Do not use chemical cleaning agents that might damage the plastics used in this oscilloscope. Use only deionized water when cleaning the front-panel buttons. Use a 75% isopropyl alcohol solution as a cleaner and rinse with deionized water. Before using any other type of cleaner, consult your Tektronix Service Center or representative.

To prevent getting moisture inside the instrument during external cleaning, use only enough liquid to dampen the cloth or applicator.

Adjustment interval

The voltage and timing references inside the instrument are very stable over time and should not need routine adjustment.

If the instrument fails the performance tests in the Specifications and Performance Verification manual, adjustment may be required. This manual was provided with your product, and can also be found at www.tektronix.com/manuals by searching for your product.

If periodic calibration is one of your requirements, a general rule is to verify performance and make adjustments (only if needed) every 2000 hours of operation or once a year if the instrument is used infrequently.

Adjustment

Adjustment can be performed only by a Tektronix Service Center. See Contacting Tektronix, following the title page in this manual, for information on contacting Tektronix Service Support.

Flat panel display cleaning

The display is a soft plastic display and must be treated with care during cleaning.



CAUTION.

Improper cleaning agents or methods can damage the flat panel display.

Avoid using abrasive cleaners or commercial glass cleaners to clean the display surface.

Avoid spraying liquids directly on the display surface. Avoid scrubbing the display with excessive force.

Clean the flat panel display surface by gently rubbing the display with a clean-room wipe (such as Wypall Medium Duty Wipes, #05701, available from Kimberly-Clark Corporation).

If the display is very dirty, moisten the wipe with distilled water or a 75% isopropyl alcohol solution and gently rub the display surface. Avoid using excess force or you may damage the plastic display surface.



CAUTION. *To prevent getting moisture inside the instrument during external cleaning, use only enough liquid to dampen the cloth or applicator.*

Returning the instrument for service

When repacking the instrument for shipment, use the original packaging. If the packaging is unavailable or unfit for use, contact your local Tektronix representative to obtain new packaging.

Seal the shipping carton with an industrial stapler or strapping tape.

Before returning the instrument for service, contact the Service Center to get an RMA (return material authorization) number, and any return or shipping information you may need.

If the instrument is being shipped to a Tektronix Service Center, enclose the following information:

- The RMA number.
- The owner's address.
- Name and phone number of a contact person.
- Type and serial number of the instrument.
- Reason for returning.
- A complete description of the required service.

Mark the address of the Tektronix Service Center and the return address on the shipping carton in two prominent locations.

TekScope recovery report utility

The TekScope Recovery Report Utility is designed to gather logs and other files that may contain data useful to Tektronix in the diagnosis of TekScope Errors, and it creates a .zip file on the desktop to hold all of the gathered data. This compressed file is easily copied from the desktop to a removable flash drive, or you can send the file to Tektronix as an email attachment.

If you contact Tektronix for help in diagnosing TekScope Errors, you may be asked to run this utility and supply Tektronix with the .zip file.

NOTE. The utility will erase temporary data created under the account of the user that runs the utility. This allows TekScope to generate fresh files the next time it starts.

Finding the utility

A link to the utility is in the Start\All Programs\Tektronix\TekScope\ directory.

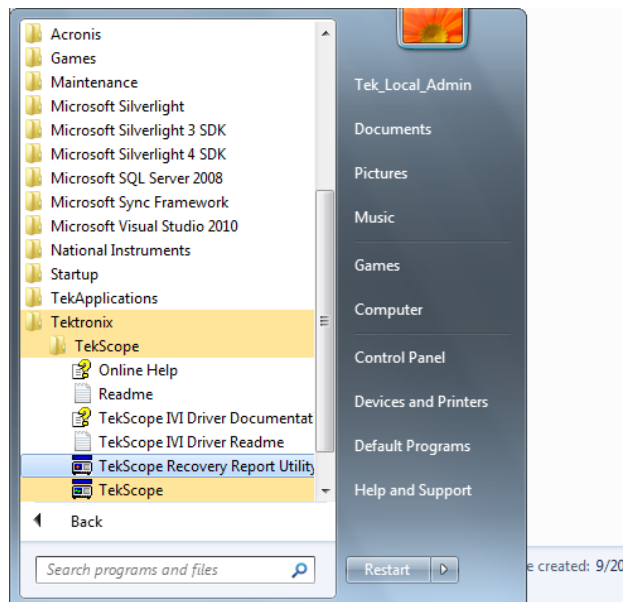

Running the utility

Click the utility link.

If TekScope is running when the utility is invoked, the utility will warn the user that TekScope must be stopped. This is necessary to allow the utility to access some of the files. The utility will automatically stop TekScope after it queries the serial number of the instrument. Click Yes to allow the utility to stop TekScope and collect files for the report.

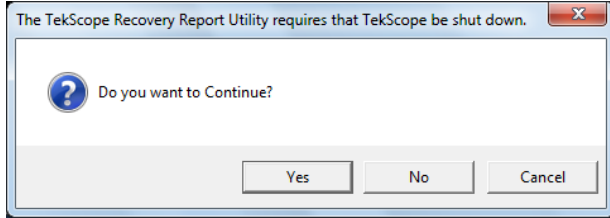

If TekScope is not running, the recovery utility will still run and will collect files for the report.

Finding the report

When the utility is finished running, the zipped report file is on the desktop.

1. In the case where TekScope was running when the utility was invoked, the name of the .zip report file created on the desktop will contain the type of instrument and the serial number. For example:
TekScope_Recovery_Report_DPO77002SX_123456789.zip
2. However, if TekScope was not running when the utility was invoked, the name of the .zip report file will not contain the serial number. For example:
TekScope_Recovery_Report_DPO77002SX.zip

Data contained in the report

When the utility is finished running, if these files exist on the instrument, the report will contain copies of these specific files:

C:\windows\Sysnative\winevt\logs\Application.evtx

C:\programdata\tektronix\ISD.XML

C:\programdata\Tektronix\TekScope\Calibration\console.log

C:\programdata\Tektronix\TekScope\Calibration\console.logOld

C:\programdata\Tektronix\TekScope\Calibration\calSPCConst.dat

C:\programdata\Tektronix\TekScope\Calibration\caldiag.log

C:\programdata\Tektronix\TekScope\Calibration\caldiag.logOld

C:\programdata\Tektronix\TekScope\Calibration\error.log

When the utility is finished running, the zipped report file will also contain copies of all files found in the following directories:

C:\programdata\Tektronix\TekScope\Internal*.*

C:\programdata\Tektronix\TekScope\Calibration\CalDramDump*.*

C:\programdata\Tektronix\TekScope\Calibration\CalDramDumpFact*.*

Data deleted by the utility

Running this utility will delete the following files:

```
C:\users\&lt;current_user&gt;\AppData\LocalLow\Tektronix\
tekScope\Internal\*.*
```

Because TekScope was having difficulties, some files may have been corrupted. Deleting these files will allow TekScope to regenerate them on the next start-up. Deleting these files may resolve the problem.

The utility log file

You can see a log file of the operation performed by the recovery report utility at:

```
C:\Temp\TekScopeRecoveryReportUtility_log.txt
```

Replaceable parts

This section contains replaceable parts information for your instrument. Use the lists in the appropriate section to identify and order replacement parts for your product.

Standard accessories

Standard accessories for these products are listed in your user manual. The user manual is available at www.tektronix.com/manuals.

Replaceable parts

Index number	Tektronix part number	Serial no. effective	Serial no. discont'd	Qty	Name & description
1	348-2037-00			4	FOOT, REAR, CORNER, SAFETY CONTROLLED
2	211-1481-00			4	SCREW, MACHINE, 10-32X. 500 PANHEAD T25, WITH BLUE NYLOK PATCH
3	348-1948-00			2	FOOT, STATIONARY, NYLON W/ 30% GLASS FILL, SAFETY CONTROLLED
4	348-1950-00			2	FOOT ASSEMBLY, FLIP
5	211-1459-00			2	SCREW, MACHINE, 8-32X. 312 PANHEAD T20, WITH BLUE NYLOK PATCH
6	348-1947-00			2	CUSHION, FOOT; SANTOPRENE, (4) BLACK 101-80
7	367-0528-00			1	HANDLE, CARRYING (GAS ASSIST AND OVERMOLDED), SAFETY CONTROLLED
8	407-4887-00			1	BRACKET, HANDLE BASE, SAFETY CONTROLLED

9	211-1265-00			2	SCREW, MACHINE, 8-32 X 1.000L PNH, BLACK OXIDE, T20, NYLOK, STEEL
10	131-9650-00			2	CONNECTOR; SMA 50 OHM, TERMINATION WITH CHAIN

Parts ordering information

Replacement parts are available through your local Tektronix field office or representative.

Changes to Tektronix products are sometimes made to accommodate improved components as they become available and to give you the benefit of the latest improvements. Therefore, when ordering parts, it is important to include the following information in your order:

- Part number
- Instrument type or model number
- Instrument serial number
- Instrument modification number, if applicable

If you order a part that has been replaced with a different or improved part, your local Tektronix field office or representative will contact you concerning any change in part number.

Appendix B, Version releases

Obtaining the latest advanced analysis application and version releases

The latest version of an optional application that you ordered with your instrument may not be installed on your instrument. The following download location is a fast and easy way to get the latest software version.

To download the latest version of software, go to the home page of the Tektronix Web site (www.tektronix.com), and locate the Downloads section on that page. Enter the application name in the ENTER MODEL NUMBER text box, and select Software in the Select Download Type pull-down menu.

NOTE. *The Release Notes file available on the Web page may contain more recent information than the readme.txt file contained within the downloadable executable file.*

To define the search criteria, use the title of the application in the ENTER MODEL NUMBER text box. For example, use the keyword DPOJET to search for and download the latest version of DPOJET.

If you purchased the application with your instrument, your Tektronix License Key will enable you to use the application.

If you are upgrading, follow the instructions on How to Install your new Tektronix License Key in the Readme.txt file to enable the application.

Index

A

- Accessories, 1
- Acquisition
 - input channels and digitizers, 50
 - sampling, 50
- Acquisition modes
 - changing, 53
- Action on event
 - setup, 91
- adjustment, 176
- adjustment interval, 176
- Amplitude measurements, 122
- Analog input
 - front-panel connector, 34
 - front-panel connectors, 34
- Analog inputs, 34
- Analyzing waveforms, 121
- Application examples, 167
- Application software, 165
- ARM status light, 78
- Automatic trigger mode, 73
- Autoset, 49
- Autoset Undo, 49
- Aux In, 34
- Auxiliary front panel, 24
- Average acquisition mode, 52

B

- B-Event scan, 82
- Bandwidth enhancement, 58
- Bandwidth limit, 59
- Bus
 - configuring, 67
 - setting up a bus, 62
 - setting up a parallel bus, 65
 - setting up a serial bus, 64
- Buses, 172
- Button
 - Set / Clear Mark, 112

C

- Calibration, 26, 43

- CAN, 172
- Chassis ground
 - front-panel connector, 34
- Cleaning, 175
- Clock Out
 - rear-panel, 35
- Communication
 - measurements, 124
- Connector cleaning, 5
- connector protection, 6
- Connectors
 - rear-panel, 35
 - rear-panel, 33
- Copying, 162
- Coupling
 - trigger, 74
- Cross Hair graticule style,
- Cursor measurements, 130

D

- Delayed trigger, 74, 79
- Display map, 36
- Display properties, 25
- Documentation, xvi
- Dots
 - displaying waveform record points as, DPO7AFP, 24
- DSP Bandwidth enhancement, 58
- Dual monitor, 30

E

- E-mail on trigger, 92
- Edge trigger
 - defined, 77
- Effective number of bits
 - enhanced, 52
- Enhanced bandwidth, 58
- Enhanced effective number of bits, 52
- ENOB, 52
- Envelope acquisition mode, 52
- Examples, 167
- Extended desktop, 30, 170
- Exterior cleaning, 175

External Clock Input, 35

External monitor, 35

F

Fast Acquisition, 57, 167

Fast Edge, 34

Fast restart, 21

FastFrame

Frame finder, 70

flat panel display cleaning, 176

Force trigger, 73

Forced shutdown, 10

Frame graticule style,

front-panel, 34

Front-panel

connectors, 34

Full graticule style,

G

Gate width and resolution bandwidth, 139

Glitch trigger

defined, 77

Glitches

capturing, 52, 57, 167

triggering on, 74

Grid graticule style,

H

Help, 39

Hi Res acquisition mode, 52

Histogram measurements, 124

Histogram setup, 132

Horizontal mode

selection, 55

Horizontal position

and math waveforms, 136

Horizontal scale

and math waveforms, 136

How to

search through and add marks to waveforms, 111

I

I2C, 172

Incoming inspection, 24, 41

Infinite persistence, 98

input connector protection, 6

Installation, 1

Instrument stacking, 10

Intensified samples

displaying waveforms as,

Interface map, 36

Interpolation, 51

L

Label

bus, 62

LAN connector

rear-panel, 35

Limit testing, 143

Linear interpolation, 100

M

Main trigger, 74, 79

Maintenance

adjustment, 176

adjustment interval, 176

cleaning, 175

exterior cleaning, 175

flat panel display cleaning, 176

parts ordering, 180

replaceable parts, 179

returning the instrument for service, 177

TekScope recovery report utility, 177

Mark, 111

Mask

autoset, 142

margin tolerance, 141

Mask testing, 140

Math

editor, 134

maximum input voltage, 5

Measurements

accuracy, 50

cursor, 130

customizing, 125

defined, 122

Menus, 40

- MIPI CSI-2, 172
- MIPI DSI-1, 172
- Monochrome green color palette, 104
- More measurements, 124
- Multi-instrument configuration
 - before startup, 13
 - connection order, 15
 - fast restart, 21
 - features not available, 22
 - instrument stacking, 10
 - power on, 16
 - Switching between modes, 20
 - Time Synchronized mode, 19, 20
- Multiple zoom areas, 108
- MultiView zoom, 107
- MyScope
 - editing, 149

N

- Normal color palette, 104
- Normal trigger mode, 73

O

- Online help, 39
- OpenChoice
 - example, 170
- Operating requirements, 2
- Operating system restore, 30

P

- Parallel, 172
- Parts ordering, 180
- Pattern trigger
 - defined, 77
- PCIe connector, 35
- Peak Detect acquisition mode, 52
- Pinpoint Triggers, 73
- Posttrigger, 73, 74
- Power button
 - green, 9
 - indicators, 9
 - no light, 9

- yellow, 9
- Power cord input, 35
- Power supply requirements, 3
- Powering off, 10
- Powering on
 - multi-instrument power on, 16
- Pretrigger, 73, 74
- Probe
 - calibration, 34, 50
 - compensation, 50
 - deskew, 50
- Product software installation, 30

R

- Random noise, 52
- Readout
 - trigger, 78
- READY status light, 78
- rear-panel, 35
- Rear-panel
 - connectors, 35
- Replaceable parts, 179
- Requirements
 - operating, 2
 - power supply, 3
- Restore
 - product software, 30
 - Windows operating system, 30
- Returning the instrument for service, 177
- Roll mode, 61
- Roll mode interactions, 61
- Runt trigger
 - defined, 77

S

- Sample acquisition mode, 52
- Sampling process
 - defined, 50
- Search, 111
- Segmented memory, 68
- Selecting an attenuator, 5
- Sequential triggering, 79
- Serial mask testing, 140
- Set / Clear Mark button, 112

- Setup/Hold trigger
 - defined, 77
- Shutdown
 - forced, 10
- Signal input, 46
- signal path compensation, 26, 43
- Sin(x)/x interpolation, 100
- Single sequence, 54
- Software
 - latest release, 181
 - optional, 165
 - version, 181
- Software installation, 30
- Spectral math expression
 - advanced, 137
- SPI, 172
- Standard accessories, 1
- Start an acquisition, 54
- State trigger
 - defined, 77
- Status message
 - calibration recommended, 26, 43
- Stop an acquisition, 54
- Switching between modes, 20

T

- TekScope recovery report utility, 177
- TekVISA installation, 30
- Temperature grading color palette, 104
- Termination voltage, 60
- Time measurements, 123
- Time Stamps
 - defined, 68
- Time Synchronized mode, 19, 20
- Timeout trigger
 - defined, 77
- Transition trigger
 - defined, 77
- TRIG'D status light, 78
- Trigger
 - B-Event scan, 82
 - coupling, 74
 - E-mail on trigger, 92
 - forcing, 73

- holdoff, 73
- level, 74
- parallel bus, 85
- posttrigger, 73, 74
- pretrigger, 73, 74
- readout, 78
- serial bus, 87
- slope, 74
- status, 78
- visual trigger, 89

- Trigger event
 - defined, 73
- Trigger Position, 81
- Trigger trigger, 35

U

- UltraSync bus cable, 13
- Undo Last Autoset, 49
- USB connector
 - front-panel connector, 34
 - rear-panel, 35
- User marks, 111
- User preferences, 49

V

- Variable persistence, 98
- Vectors
 - displaying waveforms as,
- Vertical position and autoset, 49
- VGA port
 - rear-panel, 35
- Video port, 35
- Visual Trigger, 89

W

- Waveform
 - analyzing, 121
 - search and mark, 111
 - user marks, 111
- Waveform database acquisition mode, 52
- Width trigger
 - defined, 77

Window trigger
defined, 77

Windows shutdown, 10

X

X-Y display format, 99

X-Y-Z display format, 99

Y

Y-T display format, 99

Z

Zoom, 107

Zoom graticule size, 107

