



SUMMARY

The HX5100 Series Electronic Phase Shifters are sold individually for various applications. They are designed to be used in matched pairs with the Holzworth HA7000 Series Phase Noise Analyzers. These phase shifters are frequency specific and allow for full automation of additive/residual phase noise measurements with the Holzworth phase noise test systems as shown on page 6.



SPECIFICATIONS ¹

PARAMETER	MIN	TYP	MAX	UNITS	COMMENTS
Input Frequency Range	Refer to part number guide below. Bidirectional Input / Output.				
Input Power Range			12	dBm	50Ω. Damage Threshold: 15dBm
Insertion Loss	Frequency and Control Voltage dependent. Refer to pages 2-5.				
Phase Shift Range	>180deg. Frequency and Control Voltage dependent. Refer to pages 2-5.				
Phase Noise (Additive)		-175		dBc/Hz	Input Referred, 10kHz offset
DC Control Voltage Range	0		+12.5	V _{DC}	Damage Threshold: +15V _{DC}
Input RF Connector	SMA Jack (female)				
Output RF Connector	SMA Plug (male)				
DC Connector	SMA Jack (female)				
Mechanical Dimensions	Refer to pages 7 - 8				

¹ Specifications are subject to change per the discretion of Holzworth Instrumentation, Inc.

PART NUMBER GUIDE ²

PART NUMBER	FREQUENCY (f _c)	BANDWIDTH	PHASE SHIFT RANGE
HX5100-17M	17MHz	10MHz - 23MHz	Refer to page 2
HX5100-35M	35MHz	23MHz - 47MHz	Refer to page 2
HX5100-70M	70MHz	47MHz - 94MHz	Refer to page 2
HX5100-140M	140MHz	94MHz - 187MHz	Refer to page 3
HX5100-280M	280MHz	187MHz - 375MHz	Refer to page 3
HX5100-500M	500MHz	375MHz - 750MHz	Refer to page 3
HX5100-1000M	1GHz	750MHz - 1.5GHz	Refer to page 4
HX5100-2250M	2.25GHz	1.5GHz - 3GHz	Refer to page 4
HX5100-4500M	4.5GHz	3GHz - 6GHz	Refer to page 4
HX5100-0616	11GHz	6GHz - 16GHz	Refer to page 5
HX5100-x	Contact Holzworth direct or an authorized sales representative.		

² Part numbers are subject to change per the discretion of Holzworth Instrumentation, Inc.

RoHS Compliant

HX5100 PERFORMANCE DATA

The plots contained here demonstrate the typical phase shift and insertion loss performance for each available part number. Phase Shift data demonstrates the relative performance between the listed control voltage levels.

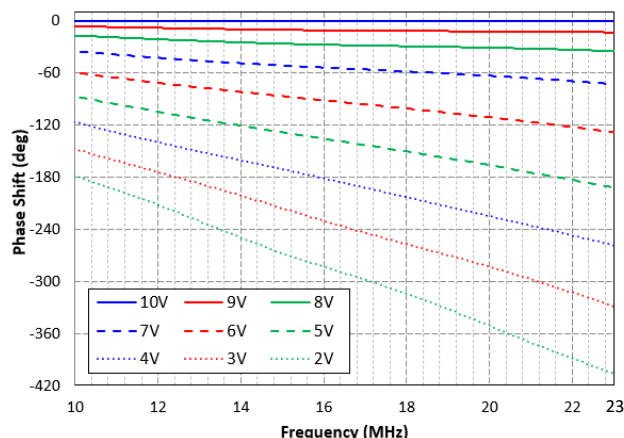

Figure 1a: HX5100-17M Phase Shift

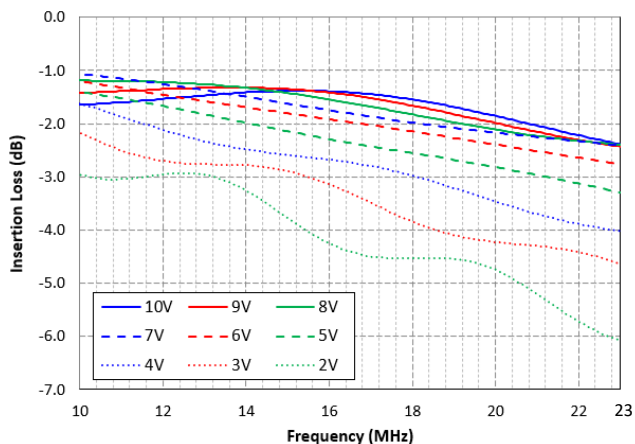

Figure 1b: HX5100-17M Insertion Loss

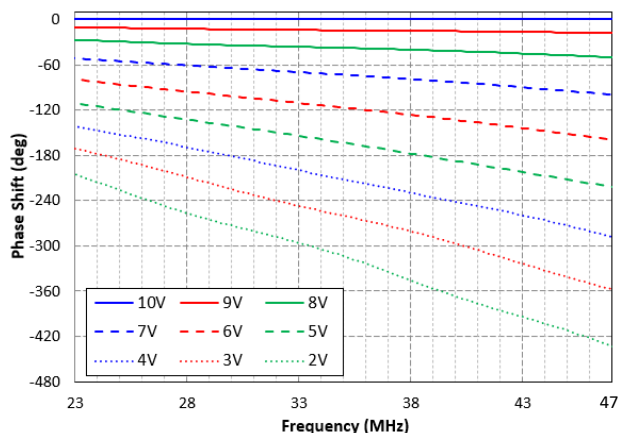

Figure 2a: HX5100-35M Phase Shift

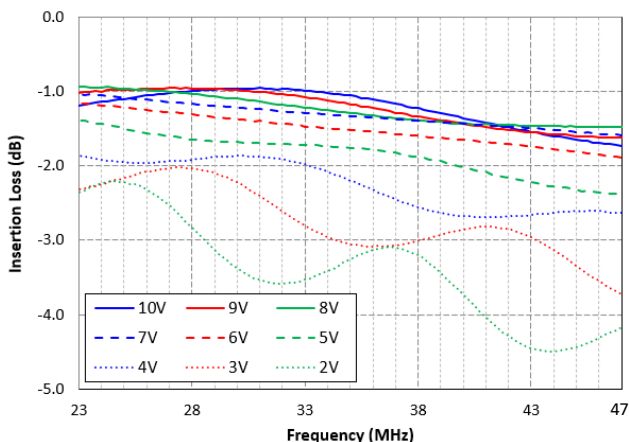

Figure 2b: HX5100-35M Insertion Loss

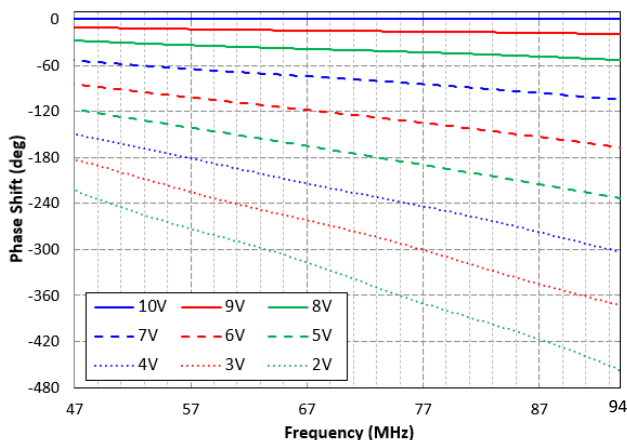

Figure 3a: HX5100-70M Phase Shift

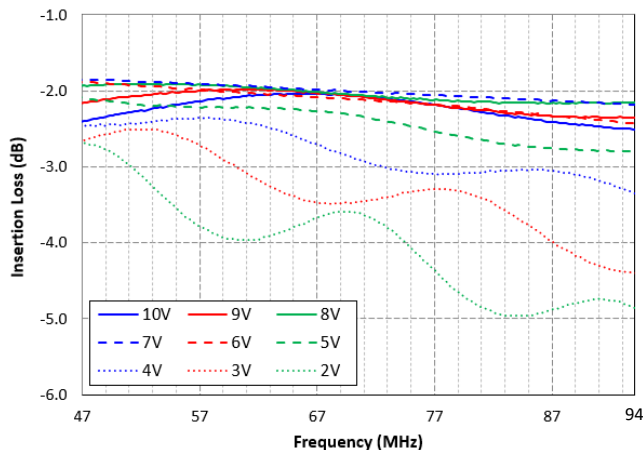

Figure 3b: HX5100-70M Insertion Loss

HX5100 PERFORMANCE DATA

The plots contained here demonstrate the typical phase shift and insertion loss performance for each available part number. Phase Shift data demonstrates the relative performance between the listed control voltage levels.

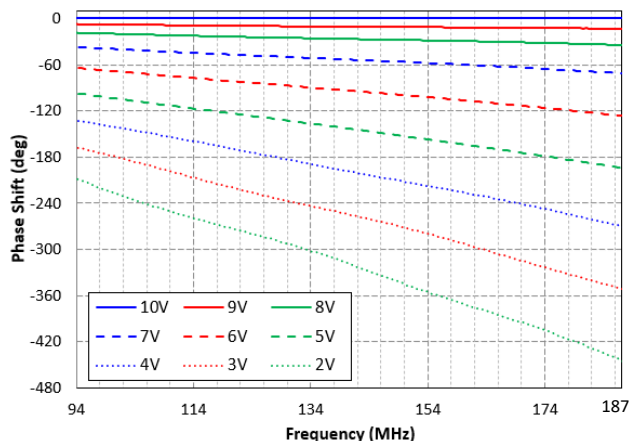

Figure 4a: HX5100-140M Phase Shift

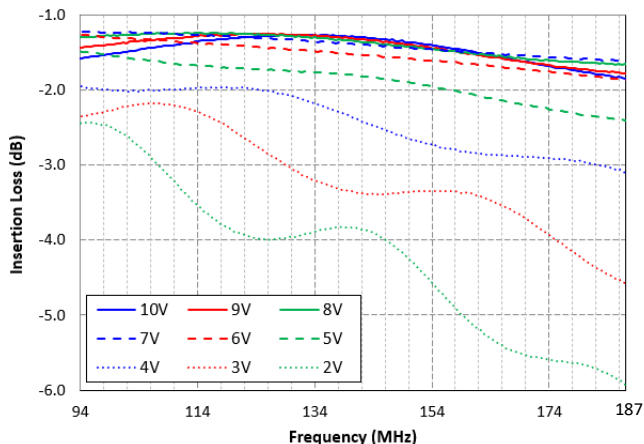

Figure 4b: HX5100-140M Insertion Loss

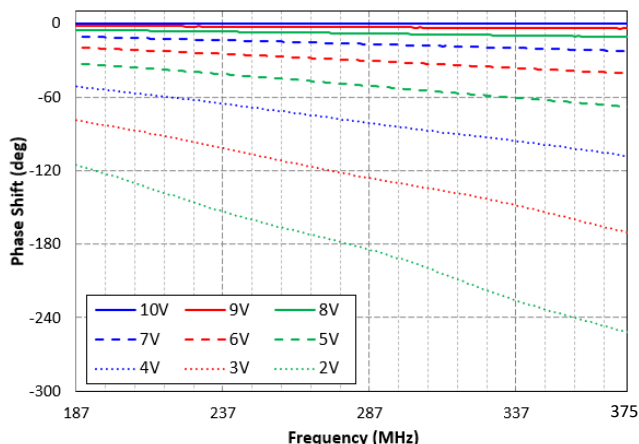

Figure 5a: HX5100-280M Phase Shift

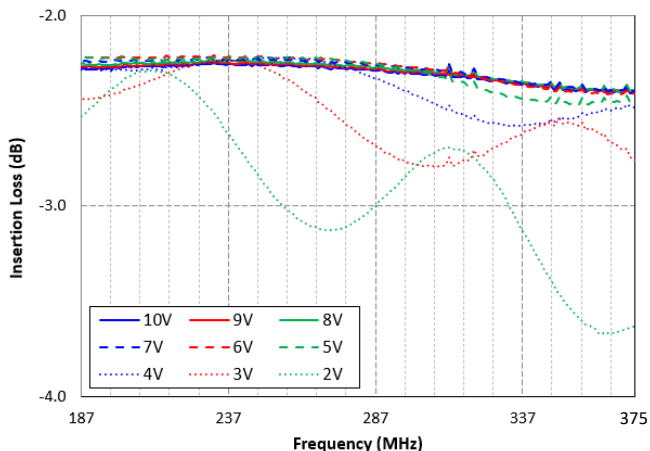

Figure 5b: HX5100-280M Insertion Loss

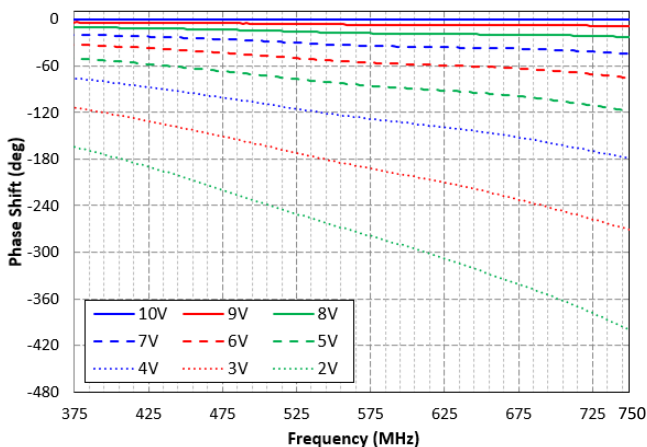

Figure 6a: HX5100-500M Phase Shift

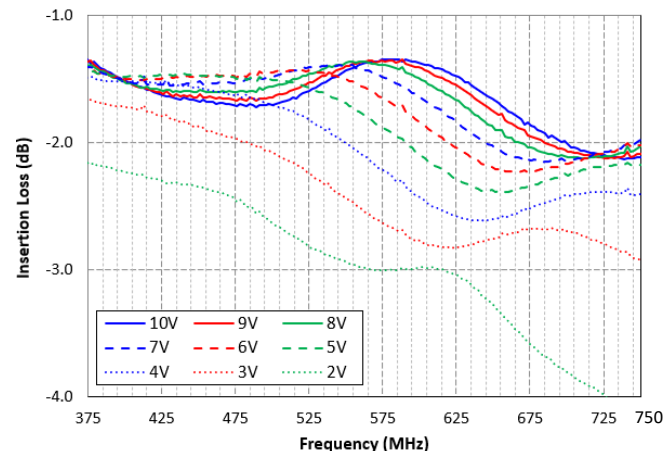

Figure 6b: HX5100-500M Insertion Loss

HX5100 PERFORMANCE DATA

The plots contained here demonstrate the typical phase shift and insertion loss performance for each available part number. Phase Shift data demonstrates the relative performance between the listed control voltage levels.

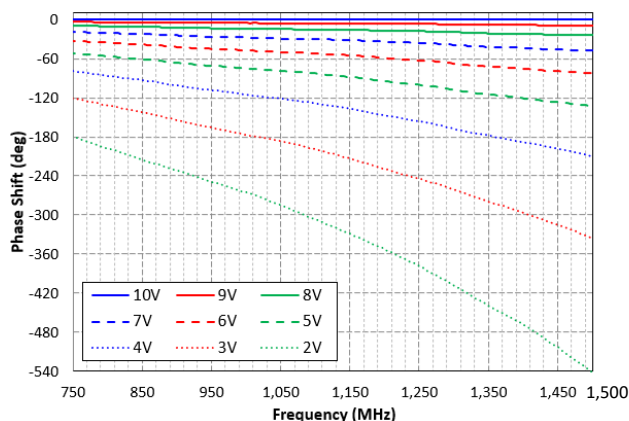

Figure 7a: HX5100-1000M Phase Shift

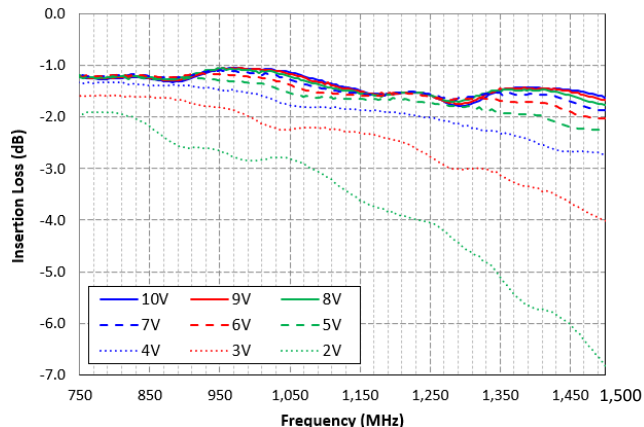

Figure 7b: HX5100-1000M Insertion Loss

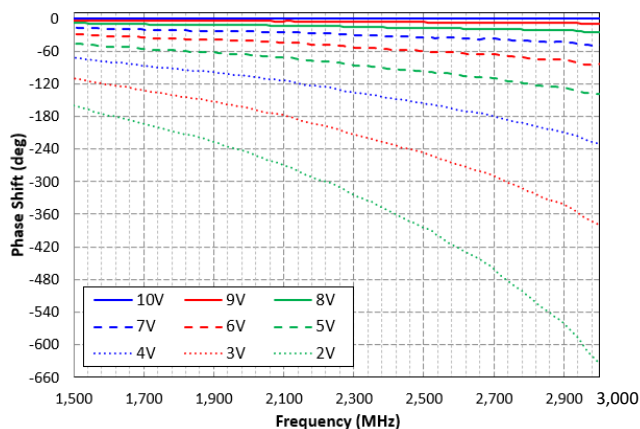

Figure 8a: HX5100-2250M Phase Shift

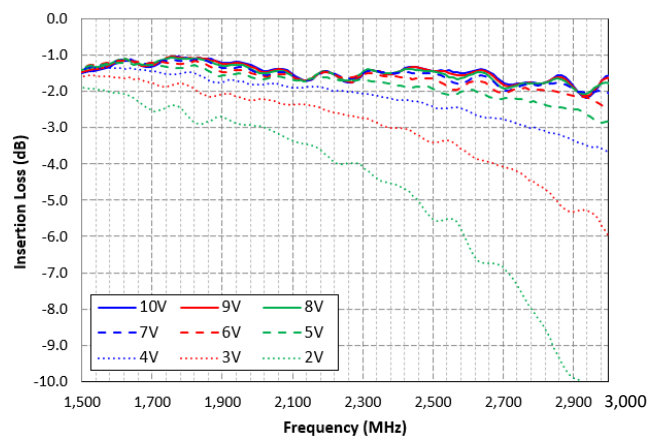

Figure 8b: HX5100-2250M Insertion Loss

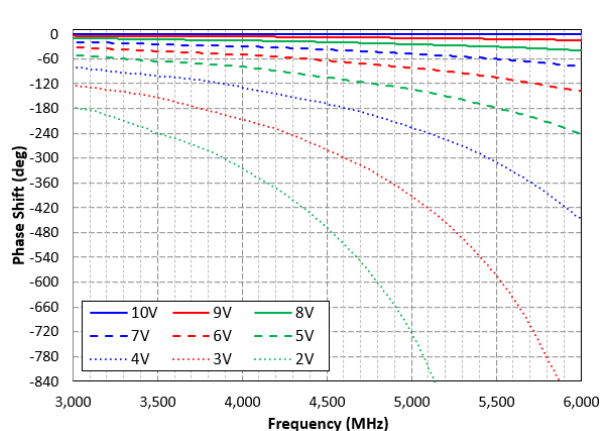

Figure 9a: HX5100-4500M Phase Shift

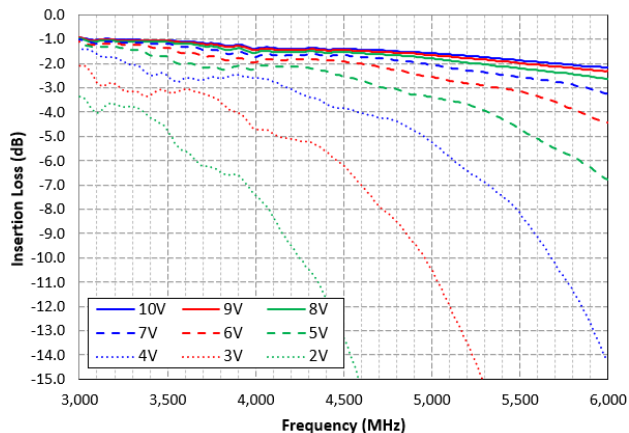

Figure 9b: HX5100-4500M Insertion Loss



HX5100 PERFORMANCE DATA

The plots contained here demonstrate the typical phase shift and insertion loss performance for each available part number. Phase Shift data demonstrates the relative performance between the listed control voltage levels.

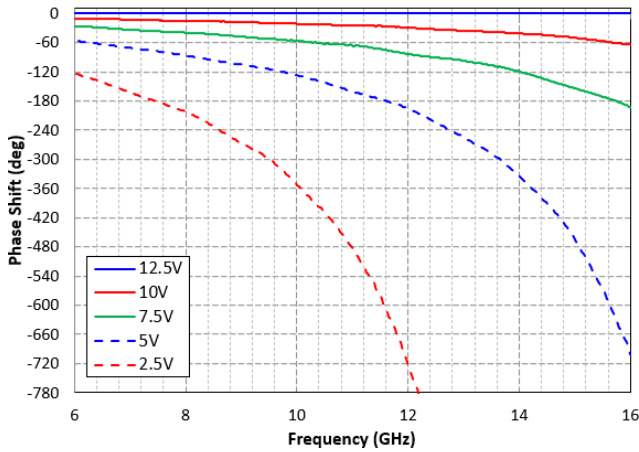

Figure 10a: HX5100-0616 Phase Shift

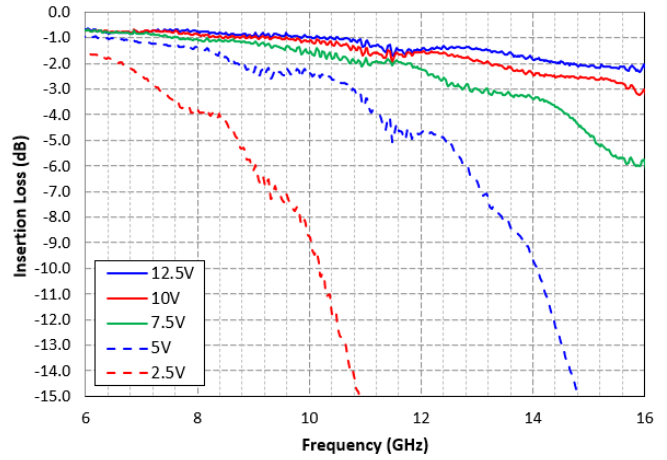

Figure 10b: HX5100-0616 Insertion Loss

RoHS Compliant

HX5100 TEST SETUP – ADDITIVE PHASE NOISE MEASUREMENT

Residual (additive) phase noise tests can be fully automated by using 2x Holzworth HX5100 Electronic Phase Shifter modules. Each matched pair of phase shifters are fully controlled by the HA7000 Series analyzer for achieving test system quadrature and fully automating the measurement. This simplifies the measurement process and offers an incredible time saving advantage in manufacturing test, full ATE tests as well as in the laboratory.

With the HX5100 Phase Shifters integrated into a basic test setup as shown below, the system will automatically set proper quadrature and so the analyzer can acquire data.

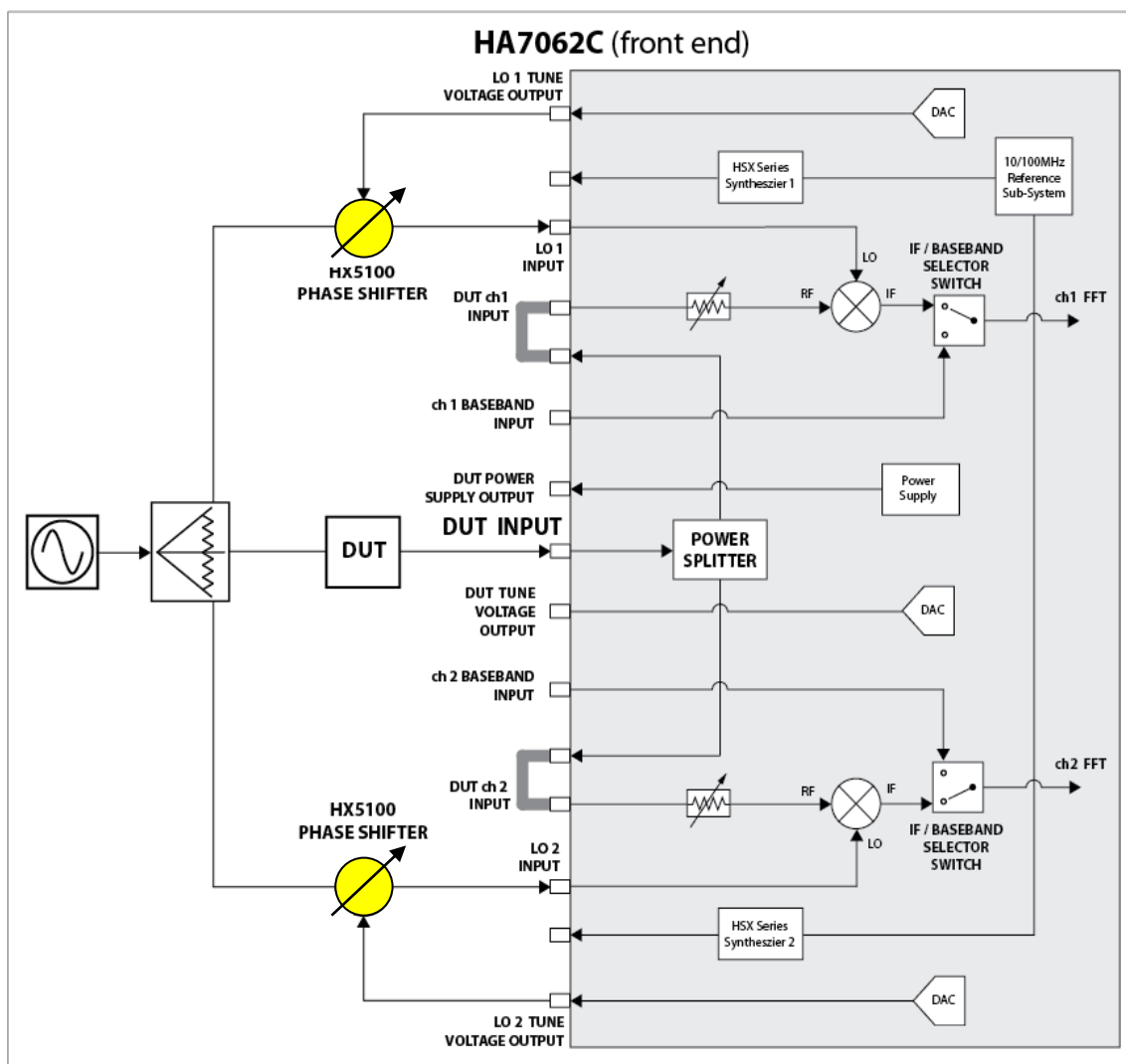

The example shown here is for an HA7062C Real Time Phase Noise Analyzer. The HX5100 Series can be used with the entire HA7000B, HA7000C and HA7000D Series of Phase Noise Analyzers as well as the HA7063A 50GHz Downconverter.



HX5100 MECHANICAL

The HX5100 Electronic Phase Shifter are available in a compact and shielded housing (based on frequency). All housings have both through and threaded mounting holes for ease of system integration.

MECHANICAL OUTLINE: Part Numbers Operating from 10MHz – 6GHz

Mechanical dimensions are listed in both inches and (mm). Tolerances are to within ±0.010 inches.

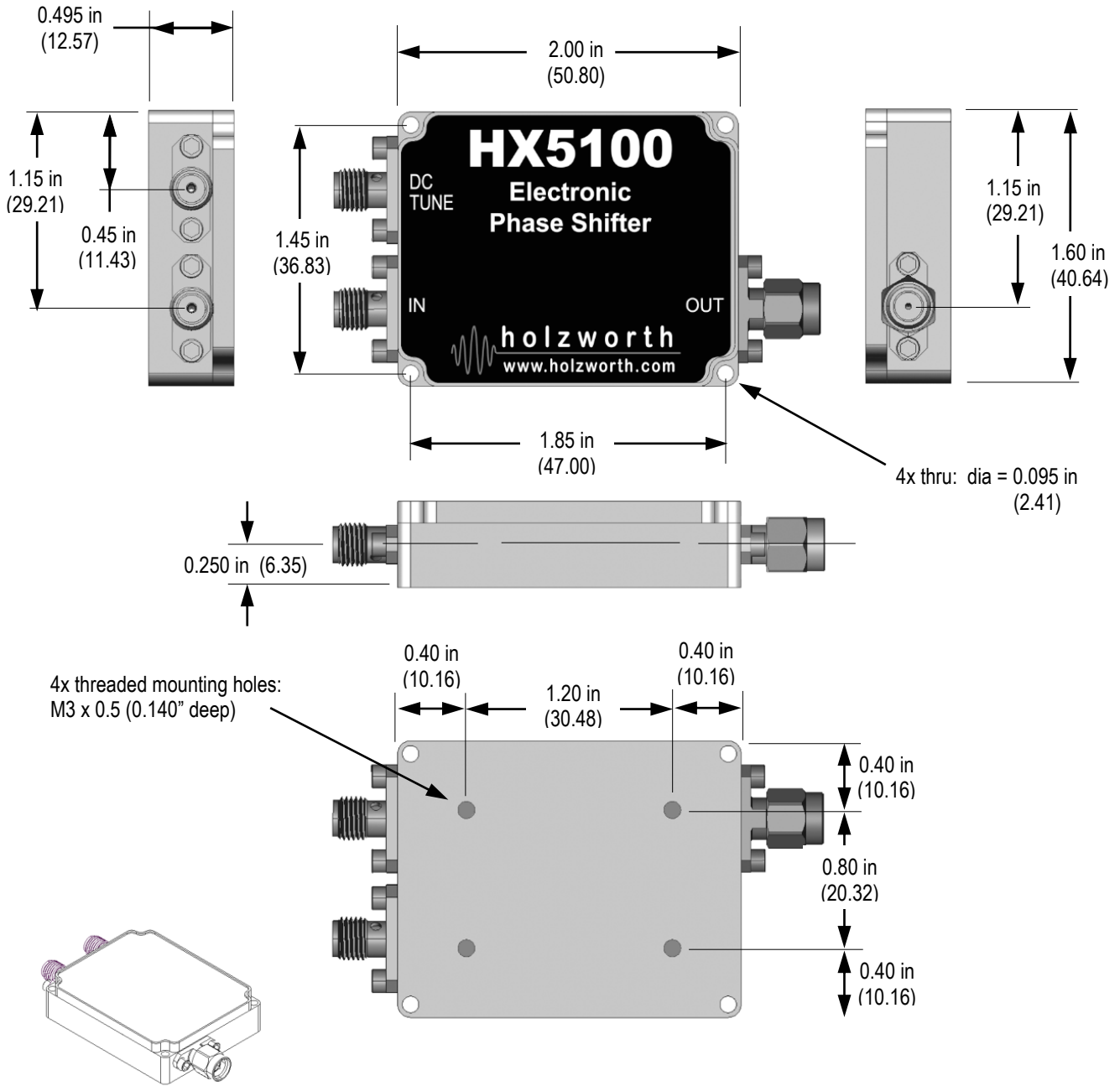

RoHS Compliant



Holzworth

MODEL HX5100 ELECTRONIC PHASE SHIFTER

HX5100 MECHANICAL

MECHANICAL OUTLINE: Part Numbers Operating at $\geq 6\text{GHz}$

Mechanical dimensions are listed in both inches and (mm). Tolerances are to within ± 0.010 inches.

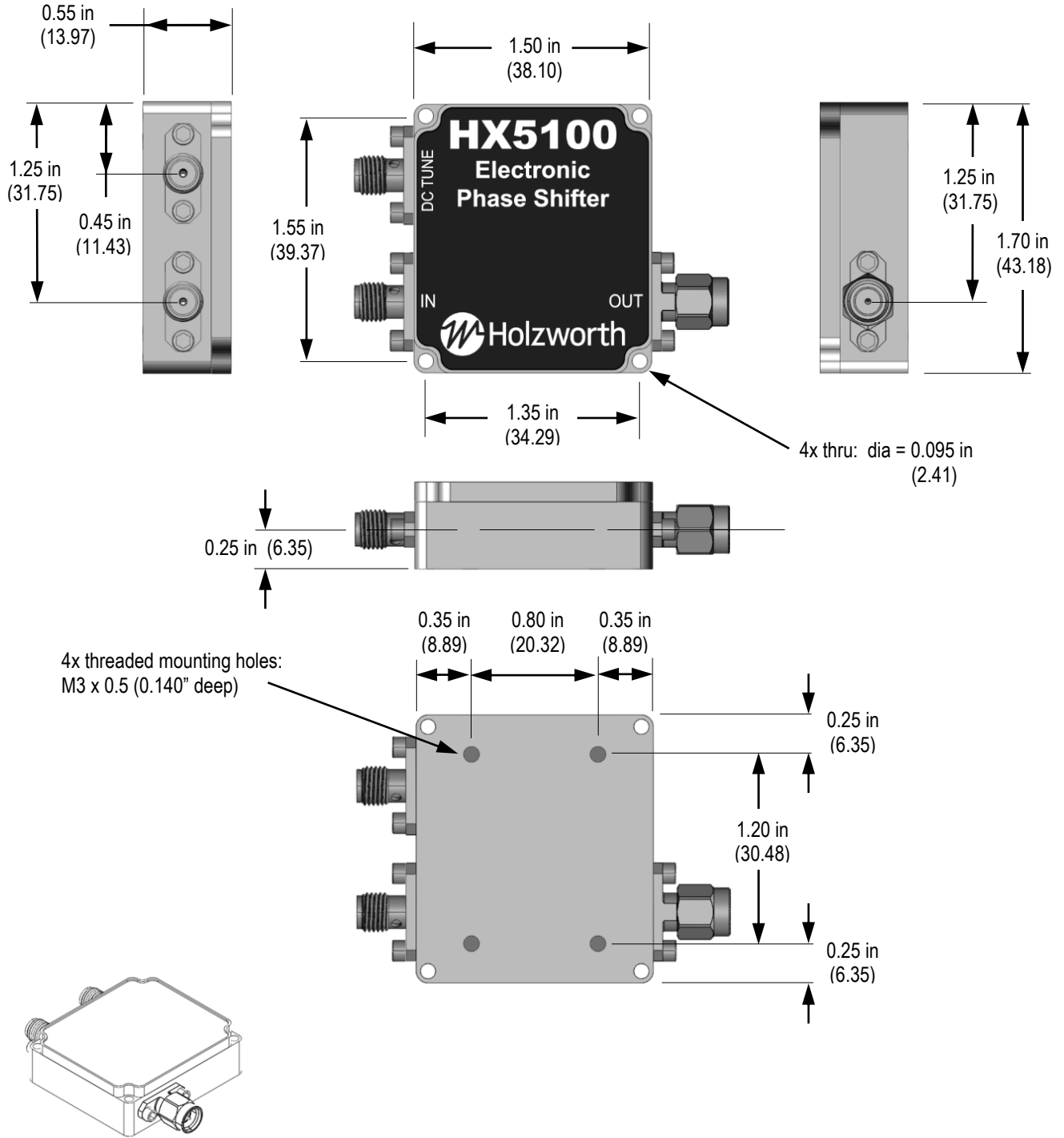

RoHS Compliant



Holzworth

MODEL HX5100 ELECTRONIC PHASE SHIFTER

WARRANTY

All Holzworth phase shifters come with a 1 year 100% product warranty covering manufacturing defects. All product repairs and maintenance must be performed by Holzworth Instrumentation. Holzworth reserves the right to invalidate the warranty for any product that has been tampered with or used improperly. Refer to Holzworth Terms & Conditions of Sales for more details.

Holzworth products are proudly designed and assembled in the USA.



CONTACT INFORMATION

Contact Holzworth directly for a product quotation, a product demonstration, or for technical inquiries.

Holzworth Instrumentation Sales Support

Phone: +1.303.325.3473 (option 1)

Email: sales@holzworth.com

Holzworth Instrumentation Technical Support

Phone: +1.303.325.3473 (option 2)

Email: support@holzworth.com

www.HOLZWORTH.com