



CE
RoHS

HSY SERIES

ULTRA LOW PHASE NOISE RF SYNTHESIZER

DATA SHEET
JUNE 2021
PRELIMINARY

PHASE COHERENT CHANNELS: 3GHz - 6GHz - 12GHz - 24GHz - 40GHz



CE
RoHS

The HSY Series Synthesizer offers industry leading phase noise and spectral purity performance as a multi-channel CW signal source. The compact 1U chassis allows for anywhere from 1x to 4x independently tunable channels (frequency / phase offset / amplitude) to optimize channel density within test system racks where real-estate is limited. Application specific frequency options can be configured to cover combinations of 10MHz to **3GHz, 6GHz, 12GHz, 24GHz, and 40GHz**. Each broadband channel output provides an accurate dynamic range of up to +20dBm to -110dBm. Holzworth's unique multi-loop architecture provides the ultimate in frequency accuracy, channel-to-channel stability and phase coherency.

FULLY INDEPENDENT CHANNELS

Each RF output is driven by a separate, internally loaded synthesizer/attenuator module. Up to 4 independently tunable synthesizers can be specified per 1U chassis allowing for the highest integrated channel density available in its class. With an average power dissipation of less than 20 Watts per channel, the HSY Series is highly efficient.

PHASE COHERENT CHANNELS

Holzworth HSY Series synthesizers offer the performance benefits of a proprietary YIG based, multi-loop architecture with a centralized reference distribution subsystem, which maintains a tight phase coherent relationship across all integrated channels.

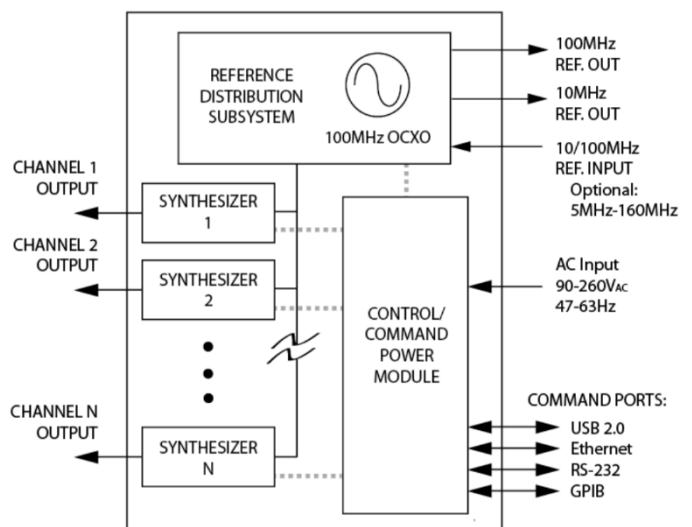

THE ULTIMATE IN CHANNEL-TO CHANNEL STABILITY

Different from traditional PLL based synthesizers, Holzworth's proprietary multi-loop architecture creates precisely synthesized signals that exhibit both instantaneous and long term stability. Temperature variations between the channels remain the only contribution to drift. The thermally optimized, fan-less chassis was specifically developed for maintaining the lowest possible thermal gradients from channel-to-channel. Channel specific thermal monitoring is available for tracking the relative channel temperature of each loaded synthesizer module.

FREQUENCY PERFORMANCE

The specified frequency performance parameters for the HSY Series RF Synthesizers are fully verified at final performance test and 100% guaranteed for the full warranty period of the product.

PARAMETER	MIN	TYPICAL	MAX	COMMENTS
Frequency Range	10 MHz 10 MHz 10 MHz 10 MHz 10 MHz		3 GHz 6 GHz 12 GHz 24 GHz 40 GHz	See page 4 for channel selection options
Frequency Step Size		0.001 Hz		
Switching Speed (Frequency)		5ms	10ms	
Phase Offset Resolution		0.1 °		Base band 750-1500MHz (N=1) 0.05 ° ±0.05 °
Internal Time Base Reference (Oscillator Aging Rate)		± 1 ppm/yr		1 st year. ±0.5 ppm/yr each subsequent year
Temperature Effects		≤ ± 1 ppm		0 to 55 °C
10MHz Reference Output Amplitude Impedance	+2 dBm	50 Ω	+6 dBm	Nominal Nominal
100MHz Reference Output Amplitude Impedance	+2 dBm	50 Ω	+6 dBm	Nominal Nominal
External Reference Input (standard) Input Frequency Lock Range External Amplitude Impedance Waveform	0 dBm	10/100MHz ± 4 ppm 50 Ω	+10 dBm	20Hz Locking BW 50 Ω (nominal) Sine or Square
OPT-REFX Ext. Ref. Input (optional) Input Frequency Range Lock Range External Amplitude Impedance Waveform	5 MHz 0 dBm	± 4 ppm 50 Ω	160 MHz ± 1 ppm +10 dBm	Any 100kHz increment within range Sine or square

¹ Specifications are subject to change per the discretion of Holzworth Instrumentation, Inc

² All MIN/ MAX (Minimum/ Maximum) performance parameters are guaranteed and 100% verified during final performance test.

³ Typical performance is "by design" and consistent with field performance data.

HSY SERIES CONFIGURATION GUIDE

The HSY Series synthesizer platform is designed to be user/application defined. Follow 4 easy steps to determine the part number with the required options.

STEP 1: SELECT TOTAL NUMBER OF CHANNELS

Select the base part number, strictly calling out the total number of channels to be loaded into the multi-channel chassis.

No. Channels	1	2	3	4
Part Number	HSY9001A	HSY9002A	HSY9003A	HSY9004A

STEP 2: SELECT CHANNEL FREQUENCY OPTIONS

Select any combination of channel frequency options. Note that the total number of channels specified here must equal the number of channels selected under STEP 1.

Frequency Range	Number of Channels per Frequency Range			
	1x	2x	3x	4x
10MHz – 3GHz	OPT-103	OPT-203	OPT-303	OPT-403
10MHz – 6GHz	OPT-106	OPT-206	OPT-306	OPT-406
10MHz – 12GHz	OPT-112	OPT-212	OPT-312	OPT-412
10MHz – 24GHz	OPT-120	OPT-220	OPT-320	OPT-420
10MHz – 40GHz	OPT-140	OPT-240	N/A	N/A

STEP 3: SELECT ADDITIONAL OPTIONS & ACCESSORIES

The options listed in this section are available for the multi-channel platform to comply with application specific requirements.

TYPE	Part Number	Description
OPTION	OPT-REFX	5MHz – 160MHz Reference Input Frequency Range (100kHz increments, degraded phase noise)
ACCESSORY	RACK-1U	19" Rack Mount Bracket Kit, 90° rear bracket, 24in max. depth
ACCESSORY	RACK2-1U	19" Rack Mount Bracket Kit, straight rear bracket, 24in max. depth
ACCESSORY	RACK-1U-L	19" Rack Mount Bracket Kit, 90° rear bracket, 29in max. depth
ACCESSORY	RACK2-1U-L	19" Rack Mount Bracket Kit, straight rear bracket, 29in max. depth

PART NUMBER EXAMPLE

Ordering a 4 channel HSY synthesizer with 1x 10MHz-6GHz channel, 2x 10MHz-12GHz channels, and 1x 10MHz-24GHz channel would result in the following configuration:

Part Number:	HSY9004A	Description:	4 channel HSY RF Synthesizer
Options:	OPT-106		1x 6GHz Channel
	OPT-212		2x 12GHz Channels
	OPT-120		1x 24GHz Channel



3GHz / 6GHz AMPLITUDE PERFORMANCE ¹

This section contains performance specifications and data for OPT-n03 (3GHz) and OPT-n06 (6GHz) channels. The specified parameters for the HSY Series RF Synthesizers are fully verified at final performance test and 100% guaranteed for the full warranty period of the product.

PARAMETER	MIN ²	TYPICAL ³	MAX ²	COMMENTS
Output Power (Calibrated) 10 MHz < f ≤ 200 MHz 200 MHz < f ≤ 5.0 GHz 5.0 GHz < f ≤ 6.0 GHz	-110 dBm -110 dBm -110 dBm		+15 dBm +18 dBm +16 dBm	Settable from -115dBm to +25dBm
Maximum Output Power (unleveled) 10 MHz < f ≤ 6.0 GHz		See plot on Page 6		
Resolution		0.01 dB		
Connector		50 Ω		SMA (Jack)
Switching Speed (Amplitude)		5 ms		
Switching Speed (Frequency)		10 ms		
Absolute Level Accuracy 10 MHz < f ≤ 6.0 GHz				35C to 45C case temperature
	MAX to +10 dBm +10 to -10 dBm -10 to -60 dBm < -60 dBm	± 1.0 dB ± 0.7 dB ± 1.0 dB ± 1.3 dB		
SSB Phase Noise 10 MHz, 10 kHz offset 100 MHz, 10 kHz offset 375 MHz < f ≤ 750 MHz, 10kHz offset 750 MHz < f ≤ 1.5 GHz, 10kHz offset 1.5 GHz < f ≤ 3.0 GHz, 10kHz offset 3.0 GHz < f ≤ 6.0 GHz, 10kHz offset				(Output set to +10dBm) Refer to Phase Noise performance plots on page 6
		≤ -160 dBc/Hz ≤ -157 dBc/Hz ≤ -148 dBc/Hz ≤ -142 dBc/Hz ≤ -136 dBc/Hz ≤ -132 dBc/Hz		
Harmonics 10 MHz < f ≤ 6.0 GHz		(2 ND / 3 RD) -30 / -45 dBc		(Output set to +10dBm) Refer to Harmonics performance plots on page 7
Sub-Harmonics 10 MHz < f ≤ 1.5 GHz 1.5 GHz < f ≤ 3.0 GHz 3.0 GHz < f ≤ 6.0 GHz		(1/2 / 3/2) N/A -80 / -90 dBc -84 / -92 dBc		(Output set to +10dBm) Refer to Spurious performance plots on page 7
Non-Harmonics / Spurious 10 MHz < f ≤ 1.5 GHz 1.5 GHz < f ≤ 6.0 GHz		-88 dBc -83 dBc		(Output set to 10dBm) Refer to Spurious performance plots on page 7

¹ Specifications are subject to change per the discretion of Holzworth Instrumentation, Inc.

² All MIN/ MAX (Minimum/ Maximum) performance parameters are guaranteed and 100% verified during final performance test.

³ Typical performance is "by design" and consistent with field performance data.

3GHz / 6GHz MAXIMUM OUTPUT POWER

The data shown here represents typical unlevelled performance.

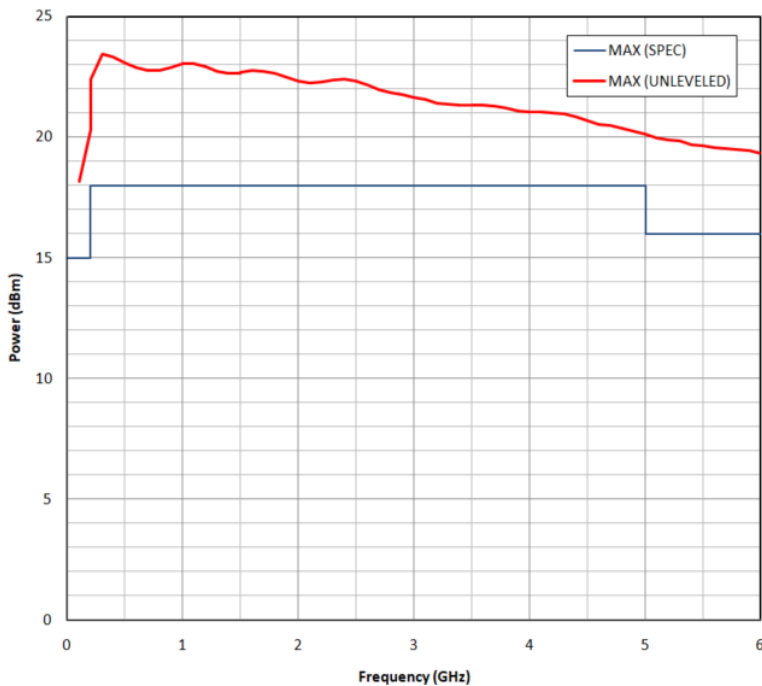

3GHz / 6GHz PHASE NOISE PERFORMANCE ($P_{out} = +10dBm$)

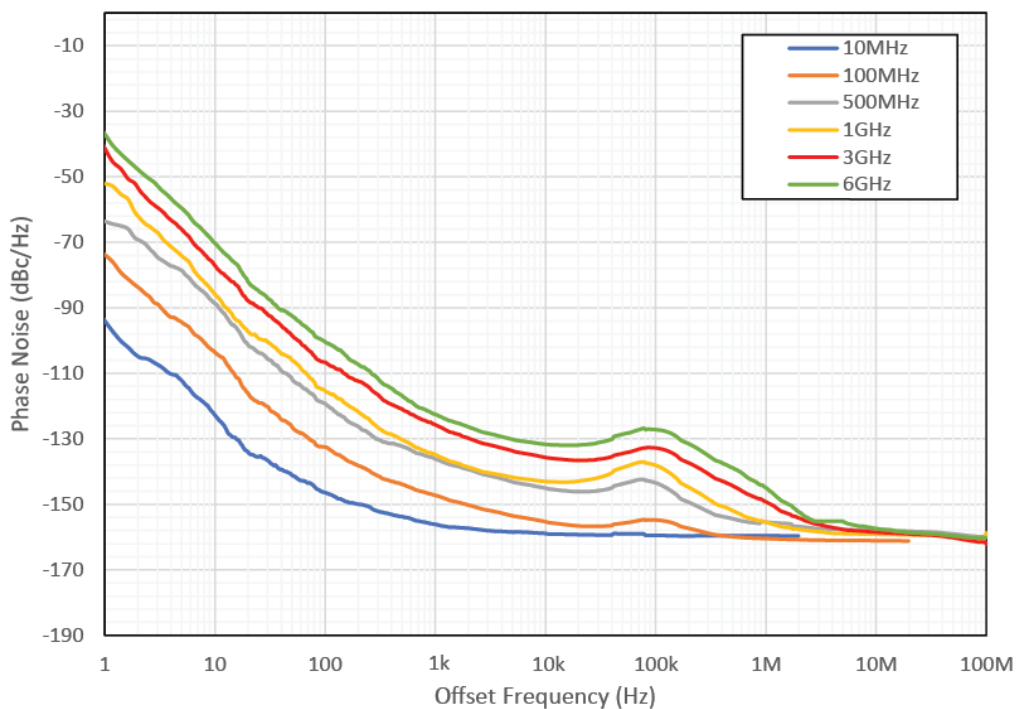

3GHz / 6GHz HARMONICS & SUB-HARMONICS

Harmonic and sub-harmonic data taken at +10dBm carrier power level.

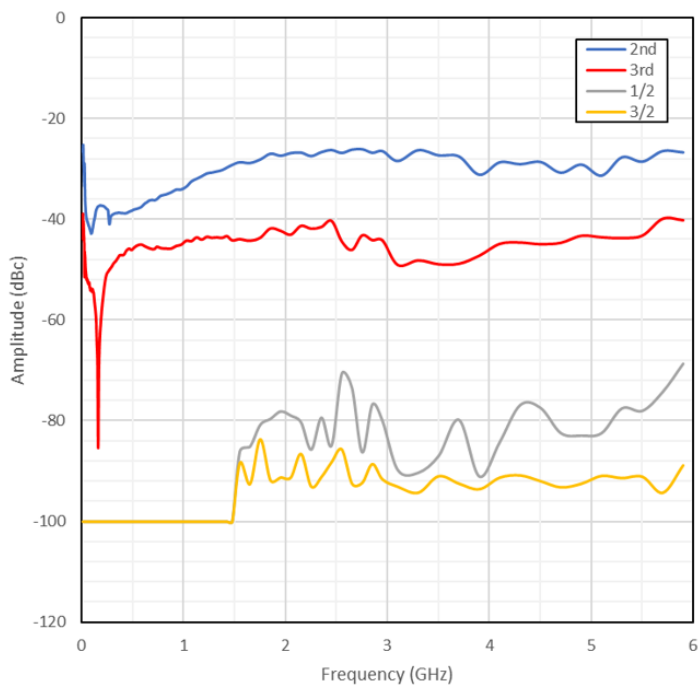

3GHz / 6GHz NON-HARMONIC SPURIOUS

Spurious data taken at +10dBm carrier power level.

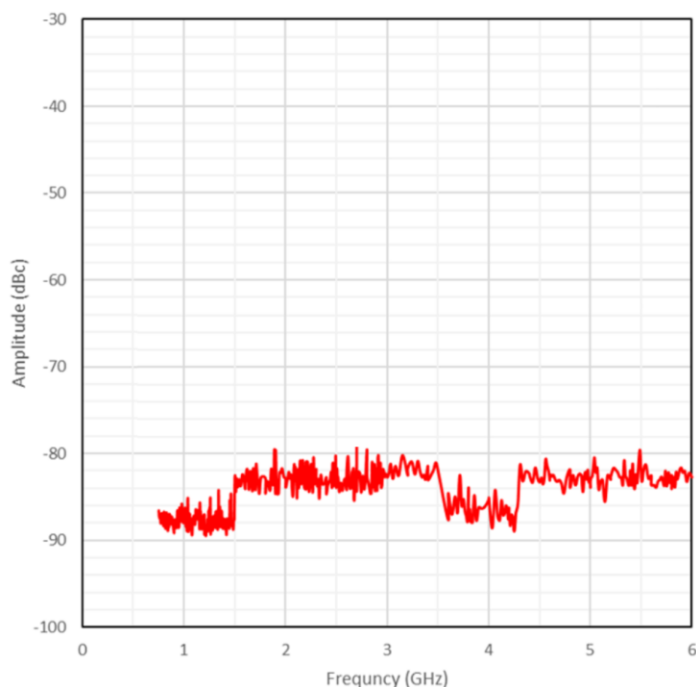

12GHz / 24GHz AMPLITUDE PERFORMANCE ¹

This section contains performance specifications and data for OPT-n12 (12GHz), and OPT-n20 (24GHz) channels. The specified parameters for the HSY Series RF Synthesizers are fully verified at final performance test and 100% guaranteed for the full warranty period of the product.

PARAMETER	MIN ²	TYPICAL ³	MAX ²	COMMENTS
Output Power (Calibrated) 10 MHz < f ≤ 16.0 GHz 16.0 GHz < f ≤ 20.0 GHz 20.0 GHz < f ≤ 24.0 GHz	-50 dBm -50 dBm -50 dBm		+18 dBm +16 dBm +14 dBm	Settable from -60dBm to +25dBm
Maximum Output Power (unleveled) 10 MHz < f ≤ 24.0 GHz		See plot on Page 9		
Resolution		0.01 dB		
Connector		50 Ω		OPT-n12: SMA (Jack) OPT-n20/OPT-n24: Super SMA (Jack)
Switching Speed (Amplitude)		5 ms		
Switching Speed (Frequency)		10 ms		
Absolute Level Accuracy 10 MHz < f ≤ 24.0 GHz	MAX to +10 dBm +10 to -10 dBm -10 to -50 dBm	± 1.4 dB ± 0.7 dB ± 1.4 dB		35C to 45C case temperature
SSB Phase Noise 10 MHz, 10 kHz offset 100 MHz, 10 kHz offset 375 MHz < f ≤ 750 MHz, 10kHz offset 750 MHz < f ≤ 1.5 GHz, 10kHz offset 1.5 GHz < f ≤ 3.0 GHz, 10kHz offset 3.0 GHz < f ≤ 6.0 GHz, 10kHz offset 6.0 GHz < f ≤ 12.0 GHz, 10kHz offset 12.0 GHz < f ≤ 24.0 GHz, 10kHz offset		≤ -160 dBc/Hz ≤ -157 dBc/Hz ≤ -148 dBc/Hz ≤ -142 dBc/Hz ≤ -136 dBc/Hz ≤ -132 dBc/Hz ≤ -124 dBc/Hz ≤ -118 dBc/Hz		(Output set to +10dBm) Refer to Phase Noise performance plots on page 9
Harmonics 10 MHz < f ≤ 5.0 GHz 5 GHz < f ≤ 24.0 GHz		(2ND / 3RD) -40 / -48 dBc -28 / -50 dBc		(Output set to +10dBm) Refer to Harmonics performance plots on page 8
Sub-Harmonics 10 MHz < f ≤ 1.5 GHz 1.5 GHz < f ≤ 6.0 GHz 6.0 GHz < f ≤ 12.0 GHz 12.0 GHz < f ≤ 18.0 GHz 18.0 GHz < f ≤ 24.0 GHz		(1/2 / 3/2) N/A -64 / -84 dBc -84 / -90 dBc -70 / -88 dBc -64 / -100 dBc		(Output set to +10dBm) Refer to Spurious performance plots on page 10
Non-Harmonics / Spurious 10 MHz < f ≤ 750 MHz 750 MHz < f ≤ 1.5 GHz 1.5 GHz < f ≤ 3.0 GHz 3.0 GHz < f ≤ 6.0 GHz 6.0 GHz < f ≤ 12.0 GHz 12.0 GHz < f ≤ 24.0 GHz		N/A -86 dBc -78 dBc -73 dBc -68 dBc -62 dBc		(Output set to 10dBm) Refer to Spurious performance plots on page 10

¹ Specifications are subject to change per the discretion of Holzworth Instrumentation, Inc.

² All MIN/ MAX (Minimum/ Maximum) performance parameters are guaranteed and 100% verified during final performance test.

³ Typical performance is "by design" and consistent with field performance data.

12GHz / 24GHz MAXIMUM OUTPUT POWER

The data shown here represents typical unlevelled performance.

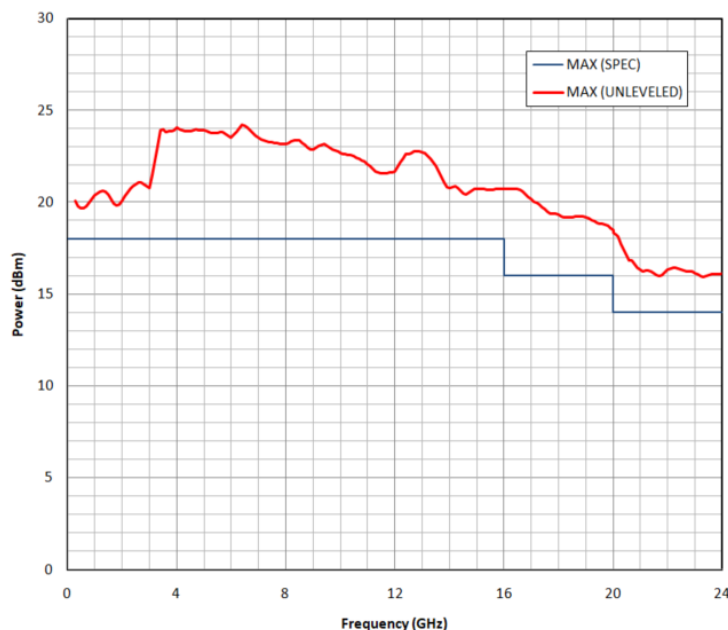

12GHz / 24GHz PHASE NOISE PERFORMANCE ($P_{out} = +10dBm$)

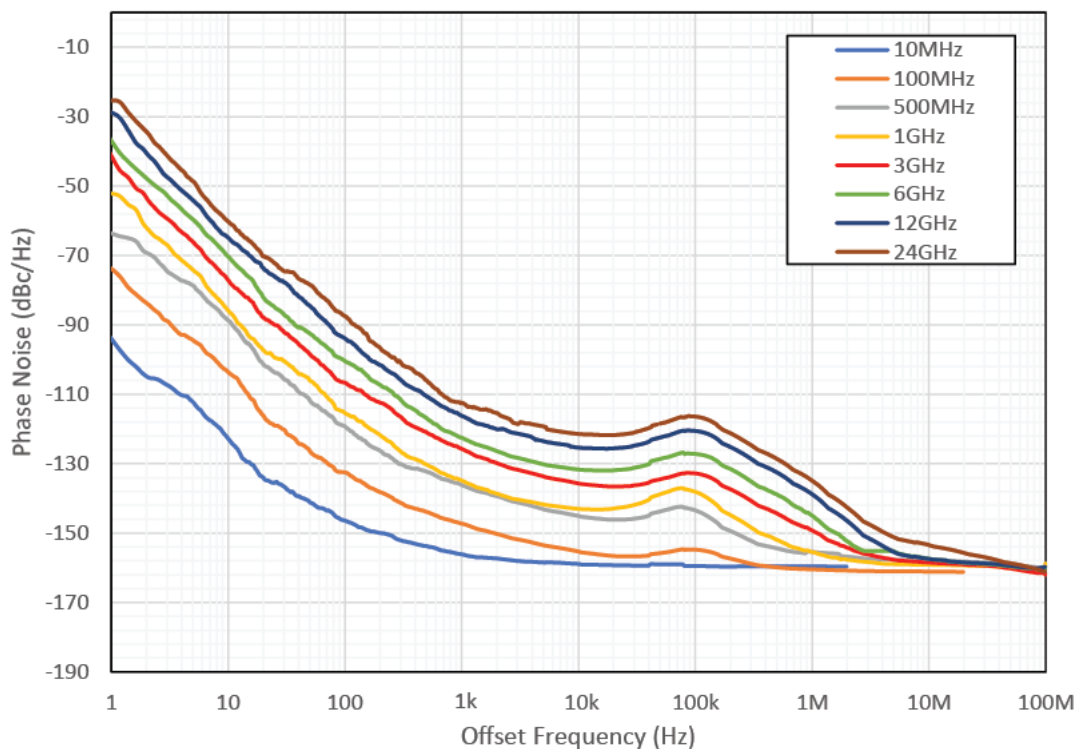

12GHz / 24GHz HARMONICS & SUB-HARMONICS

Harmonic and sub-harmonic data taken at +10dBm carrier power level.

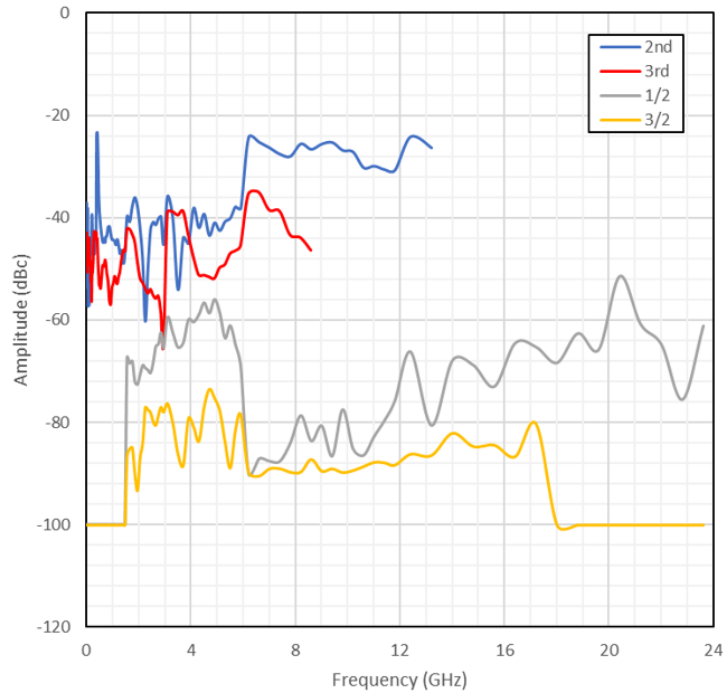
**12GHz / 24GHz NON-HARMONICS SPURIOUS**

Spurious data taken at +10dBm carrier power level.

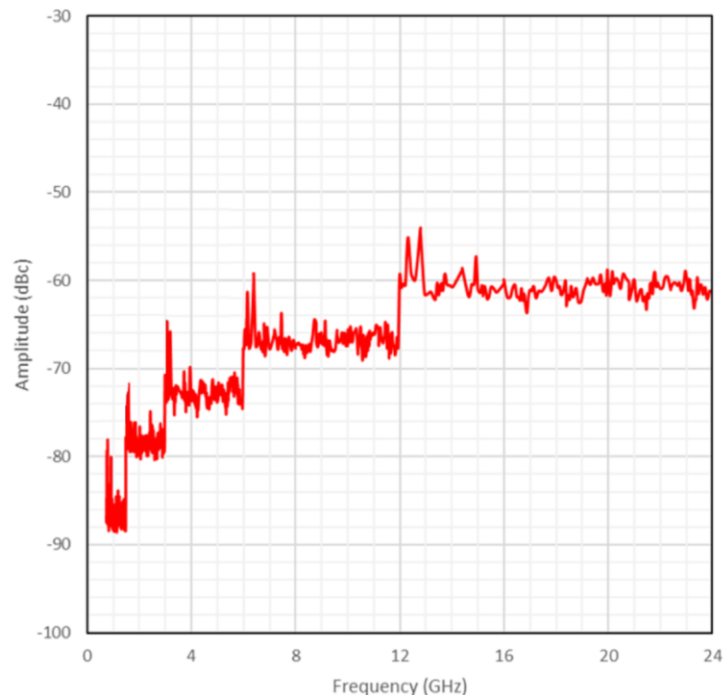

40GHz AMPLITUDE PERFORMANCE ¹

This section contains performance specifications for channels that operate to 40GHz. The specified parameters for the HSY Series RF Synthesizers are fully verified at final performance test and 100% guaranteed for the full warranty period of the product.

PARAMETER	MIN ²	TYPICAL ³	MAX ²	COMMENTS
Output Power (Calibrated) 10 MHz < f ≤ 35.0 GHz 35.0 GHz < f ≤ 40.0 GHz	0 dBm 0 dBm		+18 dBm +13 dBm	Settable from -5dBm to +25dBm
Maximum Output Power (unleveled) 10 MHz < f ≤ f ≤ 40.0 GHz		See plot on Page 12		
Resolution		0.01 dB		
Connector		50 Ω		2.92mm (Jack)
Switching Speed (Amplitude)		5 ms		
Switching Speed (Frequency)		10 ms		
Absolute Level Accuracy 10 MHz < f ≤ 35.0 GHz +18 to 0 dBm 35.0 GHz < f ≤ 40.0 GHz +12 to 0 dBm		± 0.7 dB ± 1.0 dB		35C to 45C case temperature
SSB Phase Noise (10kHz offset) 10 MHz 100 MHz 375 MHz < f ≤ 750 MHz 750 MHz < f ≤ 1.5 GHz 1.5 GHz < f ≤ 3.0 GHz 3.0 GHz < f ≤ 6.0 GHz 6.0 GHz < f ≤ 12.0 GHz 12.0 GHz < f ≤ 24.0 GHz 24.0 GHz < f ≤ 40.0 GHz		≤ -160 dBc/Hz ≤ -157 dBc/Hz ≤ -148 dBc/Hz ≤ -142 dBc/Hz ≤ -136 dBc/Hz ≤ -132 dBc/Hz ≤ -124 dBc/Hz ≤ -118 dBc/Hz ≤ -112 dBc/Hz		(Output set to +10dBm) Refer to Phase Noise performance on Page 12
Harmonics 10 MHz < f ≤ 6.0 GHz > 6.0GHz		(2ND / 3RD) -40 / -60 dBc -32 / -56 dBc		(Output set to +10dBm) Refer to plot on Page 13
Sub-Harmonics 10 MHz < f ≤ 1.5 GHz 1.5 GHz < f ≤ 6.0 GHz 6.0 GHz < f ≤ 12.0 GHz 12.0 GHz < f ≤ 18.0 GHz 18.0 GHz < f ≤ 34.0 GHz 34.0 GHz < f ≤ 40.0 GHz		(1/2 / 3/2) N/A -64 / -80 dBc -84 / -88 dBc -60 / -84dBc -88 / -84 dBc -80 / -100 dBc		(Output set to +10dBm) Refer to plot on Page 13
Non-Harmonics / Spurious 10 MHz < f ≤ 750 MHz 750 MHz < f ≤ 1.5 GHz 1.5 GHz < f ≤ 9.0 GHz 9.0 GHz < f ≤ 18.0 GHz 18.0 GHz < f ≤ 24.0 GHz 24.0 GHz < f ≤ 40.0 GHz		N/A -88 dBc -82 dBc -76 dBc -72 dBc -70 dBc		(Output set to +10dBm) Refer to Spurious performance on Page 13

¹ Specifications are subject to change per the discretion of Holzworth Instrumentation, Inc.

² All MIN/ MAX (Minimum/ Maximum) performance parameters are guaranteed and 100% verified during final performance test.

³ Typical performance is "by design" and consistent with field performance data.

40GHz MAXIMUM OUTPUT POWER

The data shown here represents typical unlevelled performance.

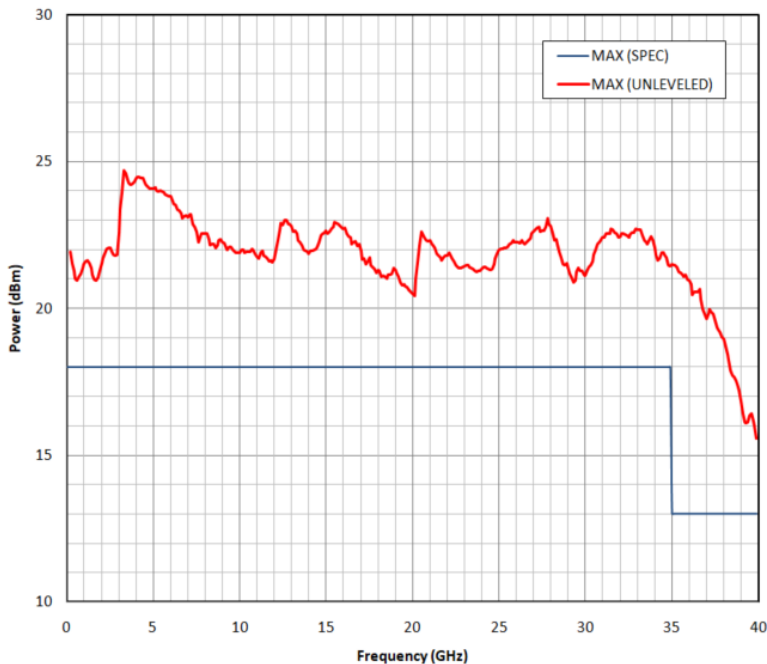

40GHz PHASE NOISE PERFORMANCE

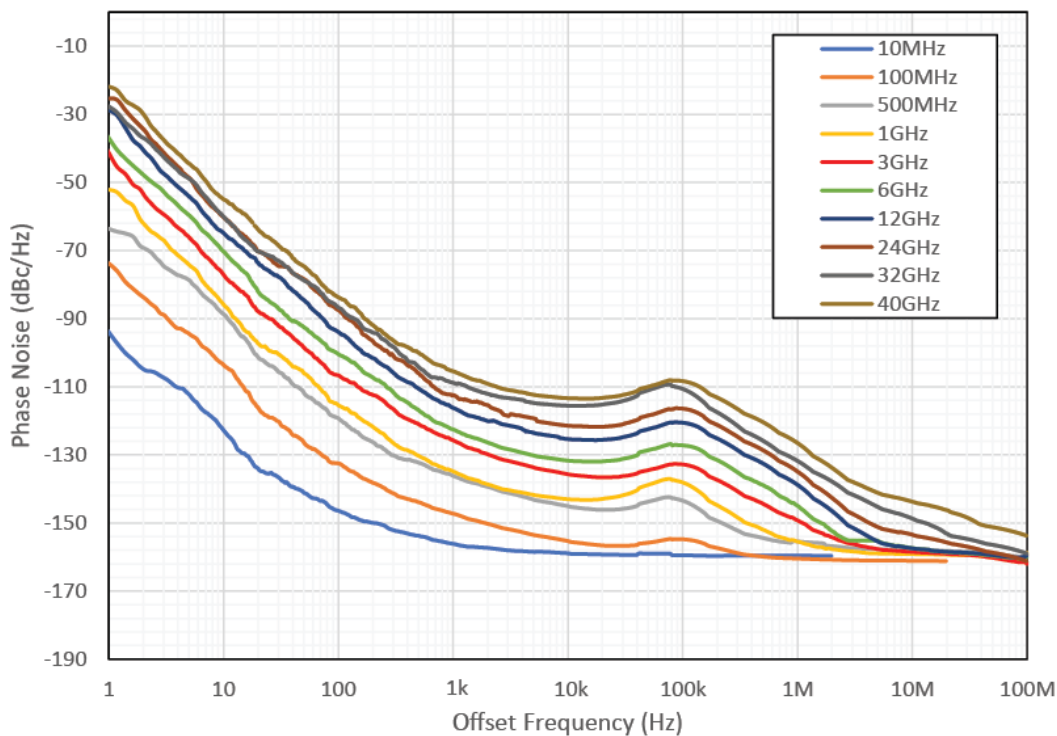

40GHz HARMONICS & SUB-HARMONICS

Harmonic and sub-harmonic data taken at +10dBm carrier power level.

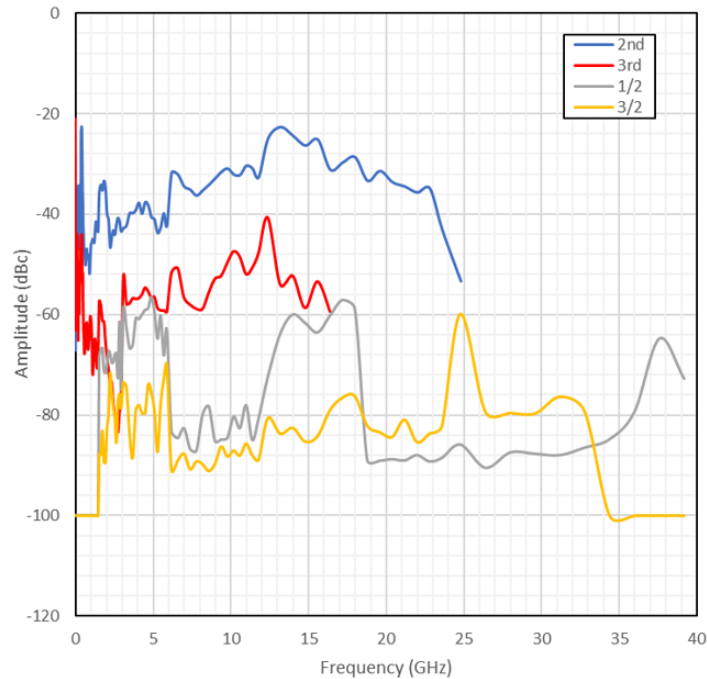
**40GHz NON-HARMONICS SPURIOUS**

Spurious data taken at +10dBm carrier power level.

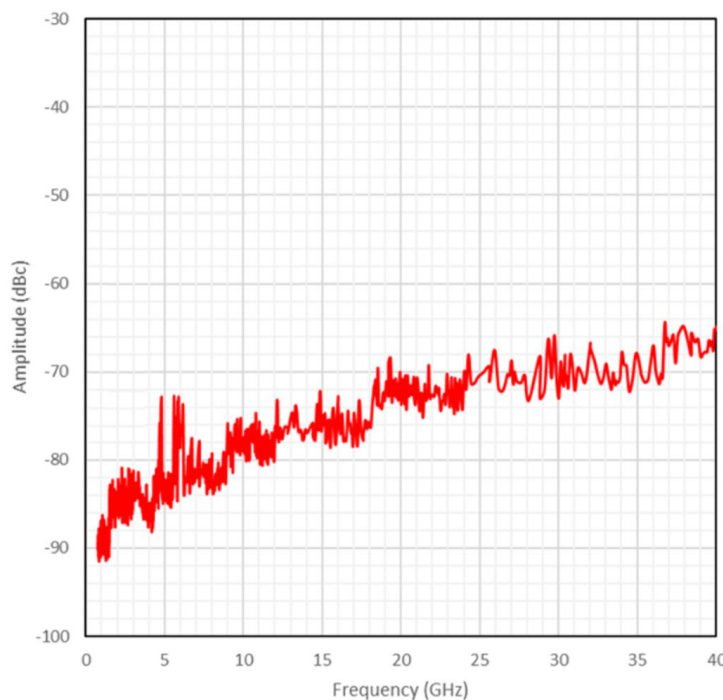

PHASE NOISE PERFORMANCE - EXTERNAL 10MHz REFERENCE

Supplying Holzworth RF Synthesizers with a low noise 10MHz external reference can improve the phase noise performance at close-to-the-carrier. The internal 100MHz oscillator phase locks to the external 10MHz via a 20Hz lock bandwidth allowing the phase noise at < 20Hz offsets to be dominated by that of the 10MHz reference signal. The plot below demonstrates the performance improvement while also showing the raw performance of the external 10MHz reference that is being applied.

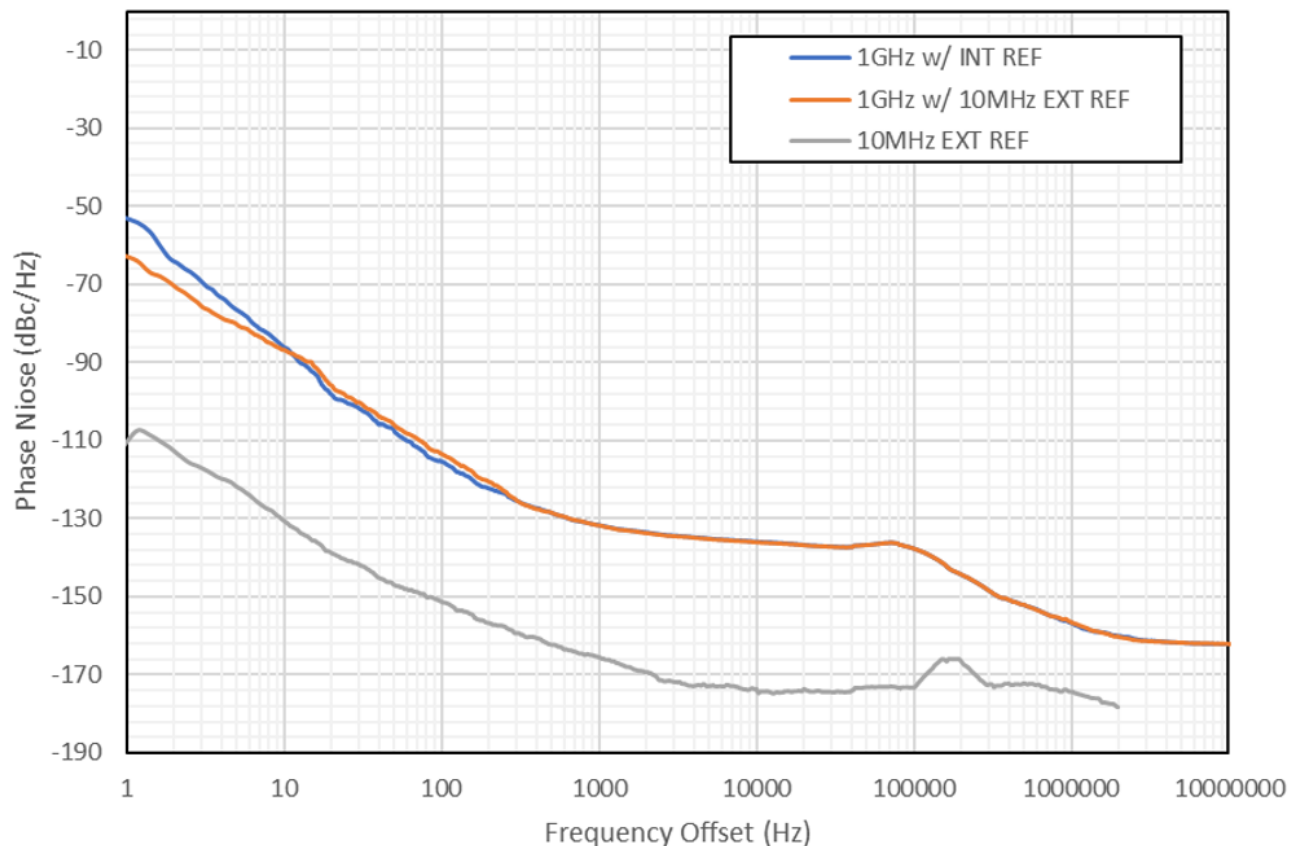

Channel to Channel Phase Coherency Phase Noise w/ External 10MHz Reference

Holzworth multi-channel synthesizers exhibit exceptional channel-to-channel phase stability. The figure below demonstrates the relative channel-to-channel stability in over 1.5hrs time frame, in an un-controlled lab environment where the ambient temperature ranged from about 22-24C. Figure 2 is a block diagram of the phase stability measurement setup. It can be seen that Holzworth multi-channel synthesizers exhibit only a fraction of a picosecond of drift.

Additional data available upon request. Contact support@holzworth.com.

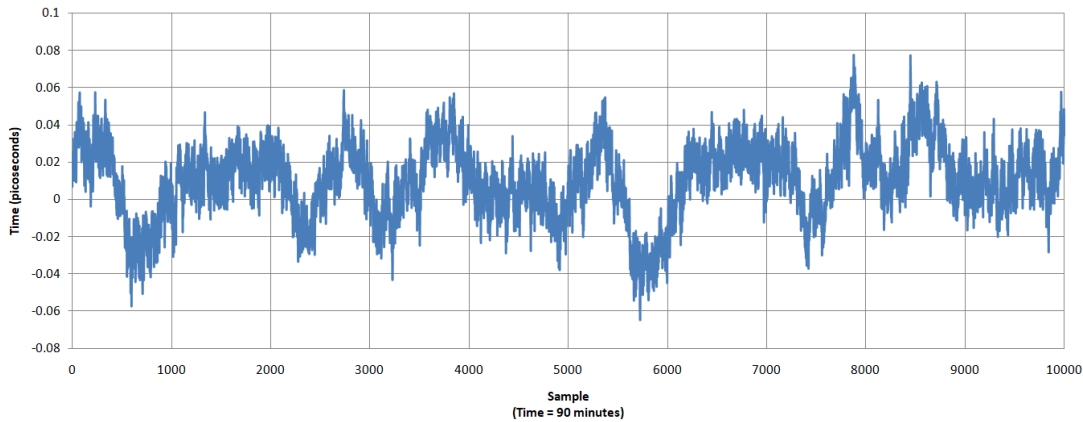

Figure 1: 7GHz Time Drift (1.5hrs, 22C - 24C Ambient Temp.)

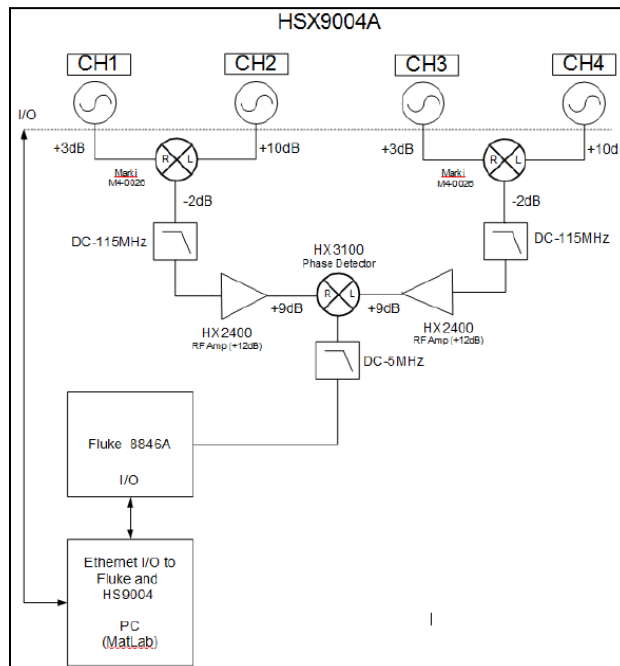

Figure 2: Phase Stability Measurement Setup

ENVIRONMENTAL SPECIFICATIONS¹

Environmental specifications are based on component margins, thermal verification testing and current draw tests. Production unit performance is not verified over temperature.

PARAMETER	MIN	TYPICAL	MAX	COMMENTS
Operating Temperature	0 C		+55 C	Case temperature
Temperature Monitor Range	-40 C		+85 C	Absolute, channel dedicated sensor
AC Power Supply	100 V _{AC}		240 V _{AC}	47 – 63Hz
Power Consumption Chassis Channel (per)		5 W 17 W		HSY9003 (3 channel) Example: 5W + (17W * 3) = 56W Total
Warm-Up Time		10 min		20 C (ambient temp. dependent)

¹ Specifications are subject to change per the discretion of Holzworth Instrumentation, Inc

DESCRIPTION	SPECIFICATION (by design)
Operating Environment Humidity Altitude Vibration	RH 20% to 80% at wet bulb temp. <29C (non-condensing) 0 to 2,000m (0 to 6,561 feet) 0.21 G-rms maximum, 5Hz to 500Hz
Storage (Non-Operating) Temperature Humidity Altitude Altitude Vibration	-10C to + 60C RH 20% to 80% at wet bulb temp. <40C (non-condensing) 0 to 4,572m (0 to 15,000 feet) 0.5 G-rms maximum, 5Hz to 500Hz

MECHANICAL CONFIGURATION

The HSY Series comes in a 1U high, rack mountable chassis. The example shown is of a 4 channel unit (front panel configuration may vary). A universal rack mount bracket kit is an available accessory (Part No.: RACK-1U, RACK-1U-L, RACK2-1U and RACK2-1U-L). Mechanical dimensions are listed in inches (and millimeters).

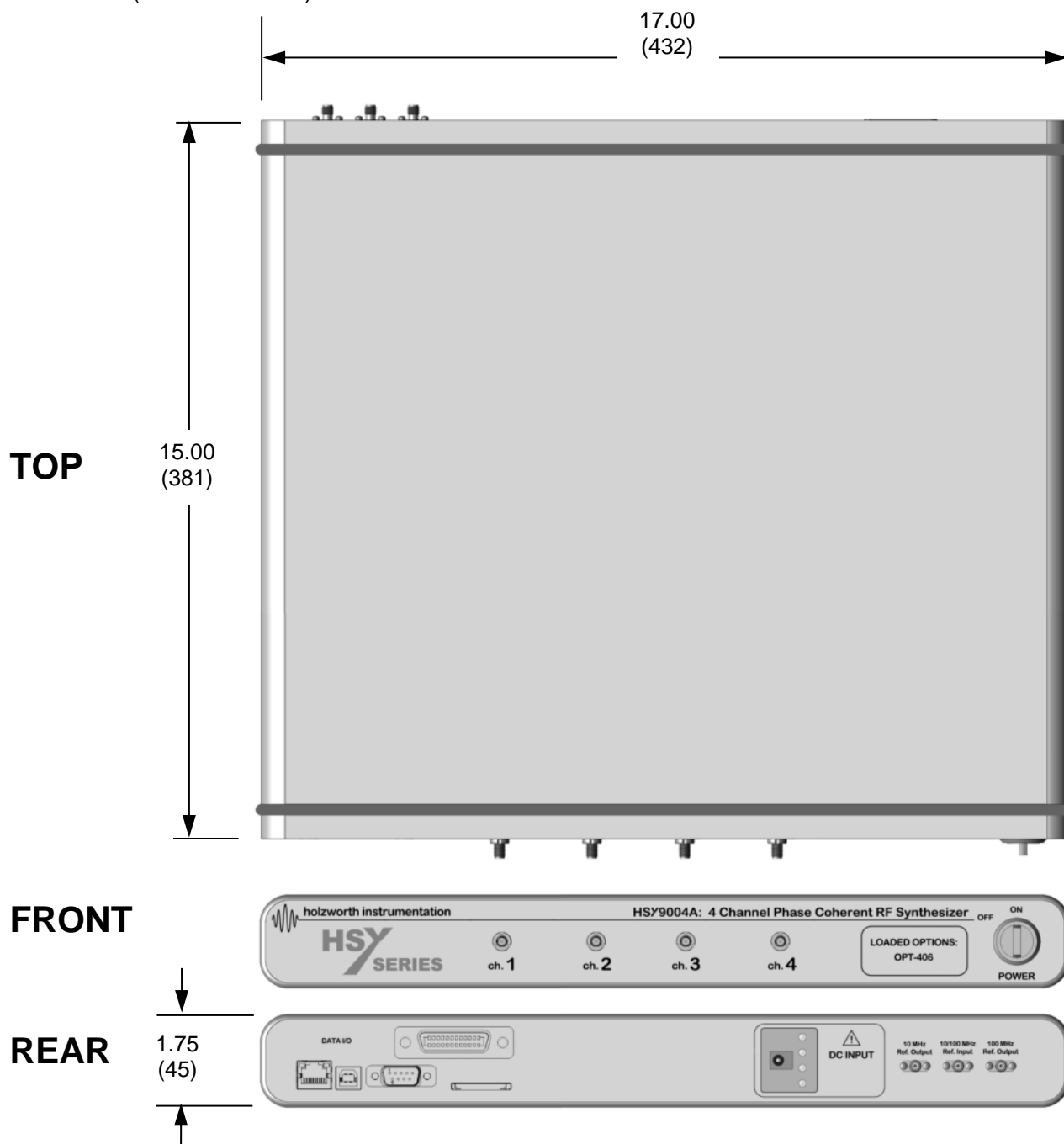

CONNECTORS and PHYSICAL SPECIFICATIONS

FRONT PANEL

DESCRIPTION	CONFIGURATION
RF Output(s) Connector Type	SMA-J, 50ohm: OPT-n03, OPT-n06, OPT-n12 (n = number of channels = number of connectors) Super SMA-J, 50ohm: OPT-n20, OPT-n24 (n = number of channels = number of connectors) 2.92mm-J, 50ohm: OPT-n40 (n = number of channels = number of connectors)

REAR PANEL

DESCRIPTION	CONFIGURATION
Reference Output Port Connector Type Output Frequency Output Level Output Waveform	SMA, 50ohm 10MHz \pm 10Hz and 100MHz \pm 100Hz +5dBm \pm 2dBm Sinusoid
Reference Input Port Connector Type Input Frequency Input Frequency (OPT-REFX) Input Level	SMA, 50ohm 10/100 MHz 5MHz - 160MHz (100kHz increments) 0dBm to +15dBm (Sinusoid or Square)
AC Power Input Connector Type AC Input Rating	IEC 320-C13 100-240V _{AC} , 47-63Hz. Specify country at time of order for proper power cord.
Data I/O Interface Connectivity Storage	USB B-Type (virtual COM port), Ethernet, RS-232, GPIB SD Card Reader (not currently active)

PHYSICAL

Dimensions (L x W x H)	1U high, 19" rack mount: 15in x 17in x 1.75in (381mm x 431.8mm x 44.5mm)
Weight	25 lb (11.34 kilograms) MAXIMUM

INCLUDED HARDWARE AND CERTIFICATIONS

Each product delivery includes specified hardware and certifications.

TYPE	DESCRIPTION	COMMENTS
HARDWARE	HSY SERIES SYNTHESIZER	DELIVERABLE
HARDWARE	AC Power Cord (7ft/2.1m) ⁶	DELIVERABLE
HARDWARE	Ethernet Cable (10ft/3m)	DELIVERABLE
HARDWARE	USB Cable (6ft/1.8m)	DELIVERABLE
WARRANTY	3 YEAR MANUFACTURER'S WARRANTY	NON-DELIVERABLE
CERTIFICATE	CALIBRATION CERTIFICATION	DELIVERABLE
CERTIFICATE	CE COMPLIANCE CERTIFICATE <i>DIRECTIVE: 2004/108/EC, TEST STANDARD: EN 61326-1: 2006</i>	WEB DOWNLOAD
CERTIFICATE	RoHS COMPLIANCE CERTIFICATE <i>DIRECTIVE: 2002/95/EC</i>	WEB DOWNLOAD
CERTIFICATE	WEEE COMPLIANCE STATEMENT <i>DIRECTIVE: 2002/96/EC</i>	WEB DOWNLOAD

⁶ Specify final country of destination for shipment with proper power cord

INTERFACE - GUI

The HSY Series hardware utilizes a virtual front panel as the control interface. Each unit comes with an open license to operate the application on any standard PC, including those equipped with touch screen monitors. The C++ based application GUI compliments the driver free instrument by being extremely reliable. The units can also be directly accessed via any data I/O interface for control via MATLAB™, LabVIEW™, C++ code, Python, VB code, *etc.*

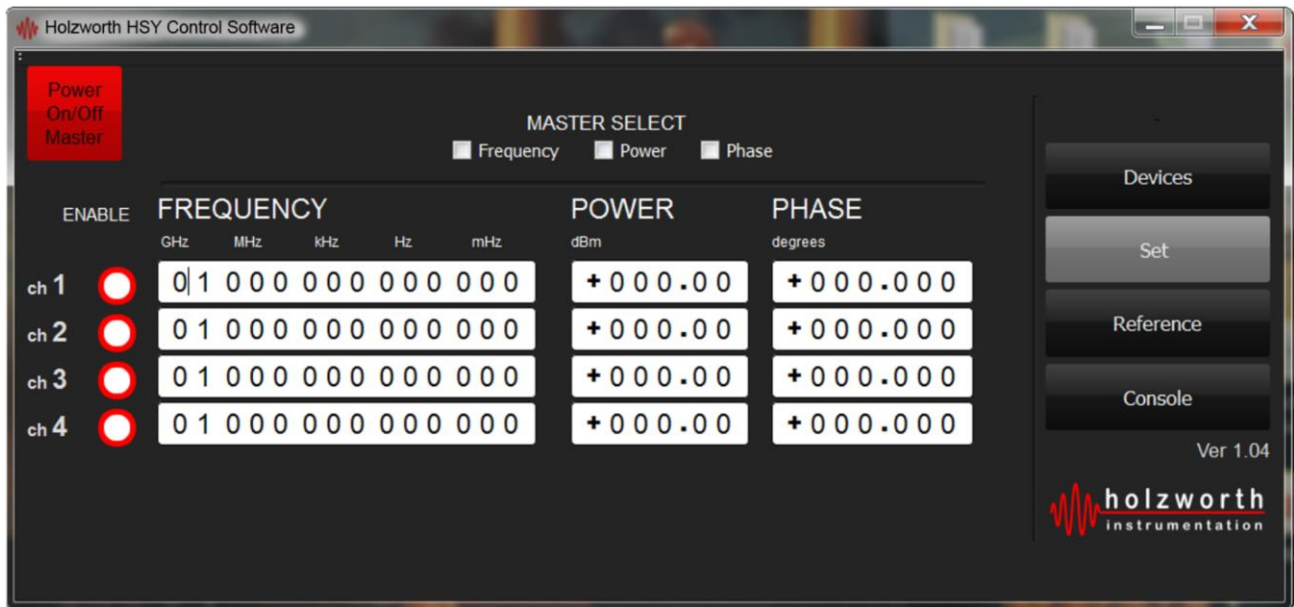



HSY SERIES RF SYNTHESIZER

WARRANTY

All Holzworth HSY Series synthesizer products come with a standard 3 year 100% product warranty covering manufacturing defects. All product repairs and maintenance must be performed by Holzworth Instrumentation. Holzworth reserves the right to invalidate the warranty for any products that have been tampered with or used improperly. Refer to Holzworth Terms & Conditions of Sales for more details.

Holzworth products are proudly designed and assembled in the USA.



CONTACT INFORMATION

Contact Holzworth directly for a product quotation, a product demonstration, or for technical inquiries.

Holzworth Instrumentation Sales Support

Phone: +1.303.325.3473 (option 1)

Email: sales@holzworth.com

Holzworth Instrumentation Technical Support

Phone: +1.303.325.3473 (option 2)

Email: support@holzworth.com

www.HOLZWORTH.com